



Infrastructure Development Division, Umgeni Water

310 Burger Street, Pietermaritzburg, 3201, Republic of South Africa
P.O. Box 9, Pietermaritzburg, 3200, Republic of South Africa
Tel: +27 (33) 341 1111 / Fax +27 (33) 341 1167 / Toll free: 0800 331 820
Email: info@umgeni.co.za / Web: www.umgeni.co.za



**Think Water,
think Umgeni Water.**



For further information, please contact:

Planning Services
Infrastructure Development Division
Umgeni Water

P.O.Box 9, Pietermaritzburg, 3200
KwaZulu-Natal, South Africa

Tel: 033 341-1522

Fax: 033 341-1218

Email: info@umgeni.co.za

Web: www.umgeni.co.za



UMGENI WATER

INFRASTRUCTURE MASTER PLAN 2020

2020/2021 – 2050/2051

JUNE 2020

Prepared by:



Nathaniel Padayachee *PrTechEng*
Planning Engineer



Sakhile Hlalukane *PrSciNat*
Hydrologist

Approved by:



Kevin Meier *PrEng*
Manager: Planning Services



Sibusiso Mjwara *PrTechEng*
Executive: Infrastructure Development

PREFACE

This Infrastructure Master Plan 2020 describes:

- Umgeni Water’s infrastructure plans for the financial period 2020/2021 – 2050/2051, and
- Infrastructure master plans for other areas outside of Umgeni Water’s Operating Area but within KwaZulu-Natal.

It is a comprehensive technical report that provides information on current infrastructure and on future infrastructure development plans. This report replaces the last comprehensive Infrastructure Master Plan that was compiled in 2019 and which only pertained to the Umgeni Water Operational area.

The report is divided into **ten** volumes as per the organogram below.

Volume 1 includes the following sections and a description of each is provided below:

- **Section 2** describes the most recent changes and trends within the primary environmental dictates that influence development plans within the province.
- **Section 3** relates only to the Umgeni Water Operational Areas and provides a review of historic water sales against past projections, as well as Umgeni Water’s most recent water demand projections, compiled at the end of 2019.
- **Section 4** describes Water Demand Management initiatives that are being undertaken by the utility and the status of Water Demand Management Issues in KwaZulu-Natal.
- **Section 5**, which also relates to Umgeni Water’s Operational Area, contains a high level review of the energy consumption used to produce the water volumes analysed in **Section 3**.
- **Section 6** provides an overview of the water resource regions and systems supplied within these regions.

The next eight volumes describe the current water resource situation and water supply infrastructure of the various systems in KwaZulu-Natal, including:

- **Volume 2 Section 7** Mgeni System.
- **Volume 3 Section 8** uMkhomazi System
- **Section 9** uMzimkhulu System
- **Section 10** Mzintlava System
- **Volume 4- Section 11** South Coast System
- **Volume 5 Section 12** North Coast System
- **Volume 6 Section 13** Upper uThukela System
- **Volume 7 Section 14** Buffalo System
- **Volume 8 Section 15** Middle uThukela System
- **Section 16** Mhlathuze System
- **Volume 9 Section 17** Umfolozi System
- **Section 18** uMkhuze / uPhongolo / Lake Sibiya System

Volume 10, Section 19 describes the wastewater works currently operated by Umgeni Water (shown in pale brown in the adjacent figure) and provides plans for development of additional wastewater treatment facilities. The status of wastewater treatment in WSA’s that are not supplied by Umgeni Water are also described in this section.

Infrastructure Master Plan 2020/2021

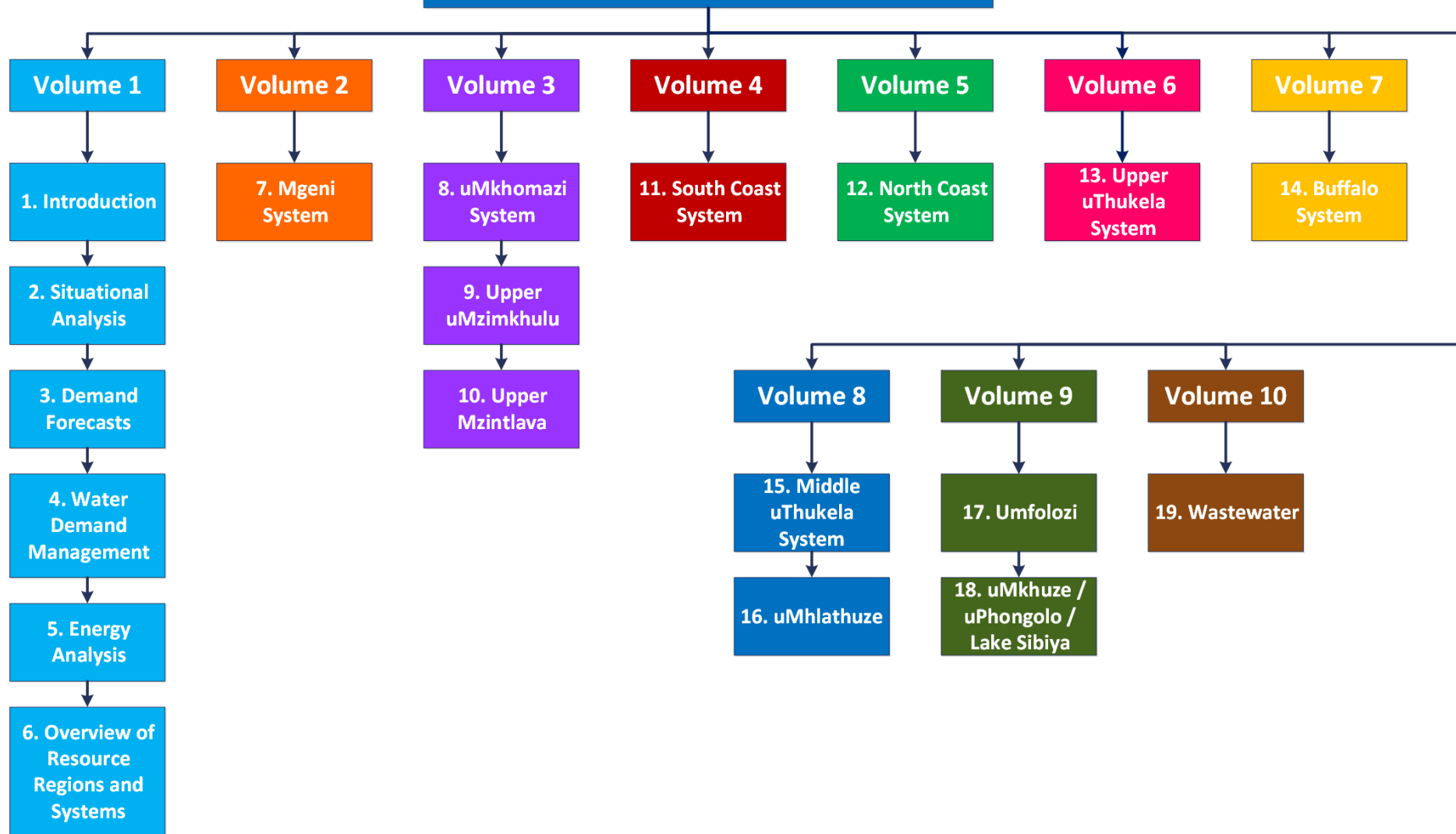

It is important to note that information presented in this report is in a summarised form and it is recommended that the reader refer to relevant planning reports if more detail is sought. Since the primary focus of this Infrastructure Master Plan is on bulk supply networks, the water resource infrastructure development plans are not discussed at length. The Department of Water and Sanitation (DWS), as the responsible authority, has undertaken the regional water resource development investigations. All of these investigations have been conducted in close collaboration with Umgeni Water and other major stakeholders in order to ensure that integrated planning occurs. Details on these projects can be obtained directly from DWS, Directorate: Options Analysis (East).

The Infrastructure Master Plan is a dynamic and evolving document. Outputs from current planning studies, and comments received on this document will therefore be taken into account in the preparation of the next update.

TABLE OF CONTENTS

| | |
|--|------|
| Preface | i |
| Table of Contents | iv |
| List of Figures | v |
| List of Tables | viii |
| List of Acronyms..... | xi |
| List of Units | 1 |
| 13. Upper uThukela System..... | 2 |
| 13.1 Synopsis of Upper uThukela System | 2 |
| 13.2 Water Resources of the uThukela System | 7 |
| 13.2.1Description of the uThukela System Water Resource Regions..... | 7 |
| 13.2.2Reserve..... | 24 |
| 13.2.3Existing Water Resource Infrastructure and Yields..... | 25 |
| 13.2.4Operating Rules..... | 42 |
| 13.3 Supply Systems | 46 |
| 13.3.1Description of the Upper uThukela System | 46 |
| 13.3.2Status Quo and Limitations of the Upper uThukela System | 143 |
| 13.4 Water Balance/Availability | 150 |
| 13.4.1Upper uThukela Region..... | 150 |
| 13.4.2Sundays Region | 151 |
| 13.4.3Bushmans Region..... | 151 |
| 13.5 Recommendations for the Upper uThukela System | 153 |
| 13.5.1Explanatory Note | 153 |
| 13.5.2System Components | 155 |
| References | 170 |
| Acknowledgements..... | l |

LIST OF FIGURES

| | | |
|--------------|--|----|
| Figure 13.1 | Schematic of the uThukela River System with key abstractions (excluding the Buffalo River)..... | 3 |
| Figure 13.2 | General layout of the uThukela River System (KZN DoT 2017, MDB 2016, Umgeni Water 2019, WR2012)..... | 4 |
| Figure 13.3 | General layout of the Upper uThukela System (KZN DoT 2017, MDB 2016, Umgeni Water 2019, WR2012)..... | 5 |
| Figure 13.4 | Network chart of the Upper uThukela System. | 6 |
| Figure 13.5 | General layout of the Upper uThukela region (DEA and GTI 2015, KZN DoT 2017, MDB 2016, Umgeni Water 2019)..... | 8 |
| Figure 13.6 | Groundwater potential in the Upper uThukela Region (KZN DoT 2017, MDB 2016, Umgeni Water 2019, WR2012)..... | 10 |
| Figure 13.7 | Percentage compliance vs. non-compliance with the South African Water Quality Guidelines for Ezakheni WTP. | 12 |
| Figure 13.8 | Percentage compliance vs. non-compliance with the South African Water Quality Guidelines for Tugela Estates WTP. | 13 |
| Figure 13.9 | General layout of the Bushmans Region (DEA and GTI 2015, KZN DoT 2017, MDB 2016, Umgeni Water 2019)..... | 15 |
| Figure 13.10 | Groundwater potential in the Bushmans Region (KZN DoT 2017, MDB 2016, Umgeni Water 2019, WR2012)..... | 17 |
| Figure 13.11 | General layout of the Sundays Region (DEA and GTI 2015, KZN DoT 2017, MDB 2016, Umgeni Water 2019)..... | 19 |
| Figure 13.12 | Groundwater potential in the Sundays Region (KZN DoT 2017, MDB 2016, Umgeni Water 2019, WR2012)..... | 21 |
| Figure 13.13 | Percentage compliance vs. non-compliance with the South African Water Quality Guidelines for Olifantskop WTP. | 23 |
| Figure 13.14 | Kilburn Dam (DWS 2008: DWS website). | 27 |
| Figure 13.15 | Jagersrust Balancing Dam (Google Earth 2019: website). | 28 |
| Figure 13.16 | Woodstock Dam (DWS unknown date: DWS website). | 29 |
| Figure 13.17 | Driel Barrage Dam (DWS unknown date: DWS website). | 30 |
| Figure 13.18 | The Thukela-Vaal Transfer Scheme in the Vaal River System (DWS 2018: Slide 6). | 31 |
| Figure 13.19 | Spioenkop Dam (DWS unknown date: DWS website). | 33 |
| Figure 13.20 | Wagendrift Dam (Michael Cookson, Unknown Date: http://www.panoramio.com). | 37 |
| Figure 13.21 | Olifantskop Dam (uThukela District Municipality 2018). | 40 |
| Figure 13.22 | Longitudinal profile of the Thukela-Vaal Scheme and the Drakensberg Pumped Storage Scheme (Ladysmith Gazette 2017: website)..... | 43 |
| Figure 13.23 | Ezakheni Water Treatment Plant (unknown date). | 49 |
| Figure 13.25 | Ezakheni WTP Supply System layout (NGI 2014; Umgeni Water 2019)..... | 51 |
| Figure 13.25 | Ezakheni WTP Supply System schematic. | 52 |
| Figure 13.26 | Tugela Estates Water Treatment Plant (Umgeni Water 2019). | 56 |
| Figure 13.27 | uMhlumayo Pump Station (Umgeni Water 2019). | 56 |
| Figure 13.29 | Tugela Estates WTP and uMhlumayo Borehole Supply System layout (NGI 2014; Umgeni Water 2019)..... | 57 |

| | | |
|--------------|--|-----|
| Figure 13.29 | uMhlamayo Pump Station adjacent to the Tugela Estates WTP (KZN DoT 2017; NGI 2014). | 58 |
| Figure 13.30 | Tugela Estates Raw Water Pump Station (Umgeni Water 2019). | 59 |
| Figure 13.31 | Tugela Estates Raw Water Holding Tanks (Umgeni Water 2019). | 59 |
| Figure 13.32 | Tugela Estates WTP clarifiers (Umgeni Water 2019). | 62 |
| Figure 13.33 | Tugela Estates WTP reservoirs (Umgeni Water 2019). | 62 |
| Figure 13.34 | Khokwane Pump Station and Sahlumbe Pump Station on the Tugela Estates WTP site (Umgeni Water 2019). | 63 |
| Figure 13.35 | Tugela Estates WTP Supply System schematic. | 65 |
| Figure 13.36 | uMhlamayo Borehole Supply System schematic. | 68 |
| Figure 13.37 | Olifantskop Water Treatment Plant (unknown date). | 70 |
| Figure 13.39 | Olifantskop WTP Supply System layout (NGI 2014; Umgeni Water 2019). | 72 |
| Figure 13.39 | Olifantskop WTP Supply System schematic. | 73 |
| Figure 13.40 | Olifantskop raw water pumps (Umgeni Water 2019). | 74 |
| Figure 13.41 | Olifantskop Clear Water Pump Station (Umgeni Water 2019). | 75 |
| Figure 13.42 | Petronella Reservoir (Umgeni Water 2019). | 75 |
| Figure 13.43 | Pipeline servitude from Petronella Reservoir (Umgeni Water 2019). | 77 |
| Figure 13.44 | Petronella Reservoir Pump Station (Umgeni Water 2019). | 78 |
| Figure 13.45 | Petronella pump as of May 2019 (Umgeni Water 2019). | 78 |
| Figure 13.46 | Ekuvukeni sales meter (Umgeni Water 2019). | 79 |
| Figure 13.47 | Waaihoek and Mabhekazi sales meters (Umgeni Water 2019). | 79 |
| Figure 13.48 | Zwelisha Moyeni WTP (Umgeni Water 2017) | 82 |
| Figure 13.49 | Zwelisha Moyeni WTP Supply System Layout NGI 2014; Umgeni Water 2020) | 85 |
| Figure 13.50 | Zwelisha Moyeni WTP Supply System Schematic (not to scale; uTDM Infrastructure) | 86 |
| Figure 13.51 | Bergville WTP (Bigen Africa, O & M Manual Bergville, 2009) | 89 |
| Figure 13.52 | Bergville WTP Supply System Layout (NGI 2014; Umgeni Water 2020) | 92 |
| Figure 13.53 | Bergville WTP Supply System Schematic (not to scale; uTDM Infrastructure) | 93 |
| Figure 13.54 | Colenso WTP (Umgeni Water 2017) | 97 |
| Figure 13.55 | Colenso WTP Supply System Layout (NGI 2014; Umgeni Water 2020) | 100 |
| Figure 13.56 | Colenso WTP Supply System Schematic (not to scale; uTDM Infrastructure) | 101 |
| Figure 13.57 | Ladysmith WTP (Bigen Africa, O & M Manual Ladysmith, 2009) | 104 |
| Figure 13.58 | Ladysmith WTP Supply System Layout (NGI 2014; Umgeni Water) | 108 |
| Figure 13.61 | Ladysmith WTP Supply System Schematic (not to scale; uTDM Infrastructure).. | 109 |
| Figure 13.60 | Archie Rodel WTP (Umgeni Water 2017) | 113 |
| Figure 13.61 | Archie Rodel (Estcourt) WTP Supply System Layout (NGI 2014; Umgeni Water 2020) (Note: this map also includes George Cross WTP) | 116 |
| Figure 13.62 | Archie Rodel WTP Supply System Schematic (not to scale; uTDM Infrastructure) | 117 |
| Figure 13.63 | George Cross Water Treatment Plant (Bigen Africa, O & Manual, 2009) | 120 |
| Figure 13.64 | George Cross WTP (Estcourt) WTP Supply System Layout (NGI 2014; Umgeni Water 2020) (Note: this map also includes Archie Rodel WTP) | 123 |
| Figure 13.65 | George Cross WTP Supply System Schematic (not to scale; uTDM Infrastructure) | 124 |
| Figure 13.66 | Weenen WTP (Umgeni Water 2017) | 127 |
| Figure 13.67 | Weenen WTP Supply System Layout (NGI 2014; Umgeni Water 2020) | 132 |
| Figure 13.68 | Weenen WTP (Old WTP and New WTP) Supply System Schematic (not to scale; uTDM Infrastructure) | 133 |

| | | |
|--------------|--|-----|
| Figure 13.69 | Overview of Tugela Ferry WTP, uMzinyathi DM O&M Manual (Dec2016)..... | 136 |
| Figure 13.70 | Tugela Ferry WTP Supply System Layout (NGI 2014; Umgeni Water 2020) | 139 |
| Figure 13.71 | Tugela Ferry WTP Supply System Schematic (not to scale; uMzinyathi DM Infrastructure)..... | 140 |
| Figure 13.72 | Water Demand from Ezakheni WTP | 143 |
| Figure 13.73 | Water Demand from Tugela Estates WTP..... | 145 |
| Figure 13.74 | Water Demand from Olifantskop WTP | 147 |
| Figure 13.75 | Water balance for the Olifantskop Dam/Ekuvukeni Water Supply Scheme (DWA 2012: 21). | 151 |
| Figure 13.76 | Water Reconciliation options to meet water requirements for Weenen Water Supply Scheme (DWS 2011: 32) | 152 |
| Figure 13.77 | Water Reconciliation options to meet water requirements for Weenen Water Supply Scheme (DWS 2011: 35) | 153 |
| Figure 13.78 | Integrated asset management (DWS 2018: 5-14)..... | 154 |
| Figure 13.79 | Possible water resource infrastructure options to be investigated (after DWAF 2000 and DWA 2011, KZN DoT 2017, MDB 2016, Umgeni Water 2019, WR2012). | 163 |

LIST OF TABLES

| | | |
|-------------|---|----|
| Table 13.1 | Hydrological characteristics of the Upper uThukela Region (WR2012: Thukela Quat Info WMA 7 7Jul2015 spreadsheet). | 9 |
| Table 13.2 | Hydrological characteristics of the Bushmans Region (WR2012: Thukela Quat Info WMA 7 7Jul2015 spreadsheet). | 16 |
| Table 13.3 | Hydrological characteristics for the Sundays region (WR2012: Thukela Quat Info WMA 7 7Jul2015 spreadsheet). | 18 |
| Table 13.4 | Ecological Reserve as noted in the uThukela ISP (DWA 2004). | 25 |
| Table 13.5 | Yield information for the existing water resource in the Upper uThukela Region (DWS 2019: List of Registered Dams Database, Umgeni Water 2016). | 26 |
| Table 13.6 | Kilburn Dam (DWS 2018: Hydrographic Surveys Dams Database, DWS 2019: List of Registered Dams Database, WR2012). | 27 |
| Table 13.7 | Jagersrust Balancing Dam (DWS 2018: Hydrographic Surveys Dams Database, DWS 2019: List of Registered Dams Database, WR2012). | 28 |
| Table 13.8 | Woodstock Dam (DWS 2018: Hydrographic Surveys Dams Database, DWS 2019: List of Registered Dams Database, WR2012). | 29 |
| Table 13.9 | Driel Barrage Dam (DWS 2018: Hydrographic Surveys Dams Database, DWS 2019: List of Registered Dams Database, WR2012). | 30 |
| Table 13.10 | Spioenkop Dam (DWS 2018: Hydrographic Surveys Dams Database, DWS 2019: List of Registered Dams Database, WR2012). | 33 |
| Table 13.11 | Existing Dams in the Upper uThukela Region (DWS 2019: List of Registered Dams Database). | 34 |
| Table 13.12 | Yield information for existing water resource in the Bushmans Region (DWS 2019: List of Registered Dams Database). | 35 |
| Table 13.13 | Existing Dams in the Bushmans Region (DWS 2019: List of Registered Dams Database). | 36 |
| Table 13.14 | Wagendrift Dam (DWS 2018: Hydrographic Surveys Dams Database, DWS 2019: List of Registered Dams Database, WR2012). | 37 |
| Table 13.15 | Olifantskop Dam (DWA 2012: 17; WR2012). | 40 |
| Table 13.16 | Existing Dams in the Sundays Region (DWA 2012: 17). | 41 |
| Table 13.17 | Yield information for the existing water resource abstractions in the Sundays Region (DWA 2012: 17; 20; 24). | 41 |
| Table 13.18 | Vaal River System annual operating analysis 2018/2019 scenarios for the Thukela-Vaal Transfer (DWS 2018: Slide 59). | 43 |
| Table 13.19 | Characteristics of the Ezakheni WTP. | 50 |
| Table 13.20 | Pump details: Ezakheni Raw Water Pump Station. | 54 |
| Table 13.21 | Pipeline details: Ezakheni Raw Water Rising Mains. | 54 |
| Table 13.22 | Reservoir details: Ezakheni WTP. | 54 |
| Table 13.23 | Pump details: Ezakheni WTP. | 55 |
| Table 13.24 | Pipe details: Ezakheni WTP Supply System. | 55 |
| Table 13.25 | Characteristics of the Tugela Estates WTP. | 60 |
| Table 13.26 | Pump details: Tugela Estates Raw Water Pump Station. | 61 |
| Table 13.27 | Pipeline details: Tugela Estates Raw Water Rising Main. | 61 |
| Table 13.28 | Reservoir details: Tugela Estates Reservoirs. | 61 |
| Table 13.29 | Pump details: Tugela Estates WTP Pump Stations. | 64 |

| | | |
|-------------|--|-----|
| Table 13.30 | Pipeline details: Tugela Estates Rising Mains. | 64 |
| Table 13.31 | Pipeline details: uMhlamayo Raw Water Pipeline..... | 66 |
| Table 13.32 | Pump details: uMhlumayo Pump Station..... | 66 |
| Table 13.33 | Reservoir details: uMhlumayo Reservoirs..... | 67 |
| Table 13.34 | Characteristics of the Olifantskop WTP..... | 71 |
| Table 13.35 | Pump details: Olifantskop Raw Water Pump Station..... | 80 |
| Table 13.36 | Pipeline details: Olifantskop Raw Water Rising Main..... | 80 |
| Table 13.37 | Pump details: Olifantskop Clear Water Pump Station..... | 81 |
| Table 13.38 | Reservoir details: Petronella Reservoir..... | 81 |
| Table 13.39 | Pipeline details: Petronella Pipeline..... | 81 |
| Table 13.40 | Characteristics of the Zwelisha Moyeni WTP..... | 84 |
| Table 13.41 | Zwelisha Moyeni Raw Water Pump Stations..... | 87 |
| Table 13.42 | Pump details: Zwelisha Moyeni Clear Water Pump Station (high lift)..... | 87 |
| Table 13.43 | Zwelisha Reservoir details: Clear water system Reservoirs..... | 88 |
| Table 13.44 | Zwelisha Pipeline details: Clear water bulk Pipeline (rising mains to command reservoirs)..... | 88 |
| Table 13.45 | Characteristics of the Bergville WTP..... | 91 |
| Table 13.46 | Pump details: Bergville Raw Water Pump Stations..... | 94 |
| Table 13.47 | Pump details: Bergville Clear Water Pump Stations..... | 94 |
| Table 13.48 | Reservoir details: Clear water system Reservoirs..... | 95 |
| Table 13.49 | Bergville Pipeline details: Bulk Pipelines..... | 96 |
| Table 13.50 | Characteristics of the Colenso WTP..... | 99 |
| Table 13.51 | Pump details: Colenso Raw Water Pump Stations..... | 102 |
| Table 13.52 | Pipeline details: Colenso Raw Water Rising Mains..... | 102 |
| Table 13.53 | Pump details: Colenso Clear Water Pump Station (high lift)..... | 102 |
| Table 13.54 | Reservoir details: Clear water system Reservoirs..... | 103 |
| Table 13.55 | Pipeline details: Clear water bulk Pipeline (rising mains to command reservoirs)..... | 103 |
| Table 13.56 | Characteristics of the Ladysmith WTP..... | 107 |
| Table 13.57 | Pump details: Ladysmith Raw Water Pump Stations..... | 110 |
| Table 13.58 | Pipeline details: Ladysmith Raw Water Mains..... | 110 |
| Table 13.59 | Pump details: Ladysmith Clear Water Pump Station (high lift)..... | 111 |
| Table 13.60 | Reservoir details: Clear water system Reservoirs..... | 112 |
| Table 13.61 | Pipeline details: Clear water bulk Pipeline (rising mains to command reservoirs)..... | 112 |
| Table 13.62 | Characteristics of the Archie Rodel WTP..... | 115 |
| Table 13.63 | Pipeline details: Archie Rodel Raw Water Gravity Mains..... | 118 |
| Table 13.64 | Pump details: Archie Rodel Clear Water Pump Stations (high lift)..... | 118 |
| Table 13.65 | Reservoir details: Clear water system Reservoirs..... | 119 |
| Table 13.66 | Pipeline details: Clear water bulk Pipelines..... | 119 |
| Table 13.67 | Characteristics of the George Cross WTP..... | 122 |
| Table 13.68 | Pump details: George Cross Raw Water Pump Stations..... | 125 |
| Table 13.69 | Pipeline details: George Cross Raw Water Rising Mains..... | 125 |
| Table 13.70 | Pump details: George Cross Clear Water Pump Station (high lift)..... | 125 |
| Table 13.71 | Reservoir details: Clear water system Reservoirs..... | 126 |
| Table 13.72 | Pipeline details: Clear water bulk Pipeline (PIPELINES to command reservoirs).... | 126 |
| Table 13.73 | Characteristics of the Weenen Old WTP (1.44 Mℓ/day WTP)..... | 130 |
| Table 13.74 | Characteristics of the Weenen New WTP (2.5 Mℓ/day WTP)..... | 131 |
| Table 13.75 | Pipeline details: Weenen Raw Water Gravity Mains..... | 134 |
| Table 13.76 | Pump details: Weenen Pump Stations..... | 134 |

| | | |
|-------------|--|-----|
| Table 13.77 | Weenen Reservoir details: Clear water system Reservoirs | 135 |
| Table 13.78 | Weenen Pipeline details: Clear water bulk Pipeline (and rising mains to command reservoirs) | 135 |
| Table 13.79 | Characteristics of the Tugela Ferry WTP..... | 138 |
| Table 13.80 | Pump details: Tugela Ferry Pump Stations | 141 |
| Table 13.81 | Reservoir details: Tugela Ferry Clear Water System Reservoirs..... | 142 |
| Table 13.82 | Pipeline details: Tugela Ferry Water bulk Pipelines | 142 |
| Table 13.83 | Ezakheni WTP metered water sales for October 2020 – March 2020 (Umgeni Water 2020: spreadsheet) | 143 |
| Table 13.84 | Ezakheni WTP inlet meters (Umgeni Water 2018: 13) | 144 |
| Table 13.85 | Ezakheni WTP outlet/pump station meters (Umgeni Water 2018: 13) | 144 |
| Table 13.86 | Aasvoëlkop Command Reservoir outlet | 144 |
| Table 13.87 | Tugela Estates WTP metered water sales for October 2020 – March 2020 (Umgeni Water 2020: spreadsheet) | 146 |
| Table 13.88 | Olifantskop WTP metered water sales for October 2019 – March 2020 (Umgeni Water 2020: spreadsheet) | 148 |
| Table 13.89 | Long-term stochastic yields from Olifantskop Dam (DWA 2012: 24)..... | 148 |
| Table 13.90 | Summary of Olifantskop WTP metered consumption for January – April 2019 (after Umgeni Water 2019: spreadsheet) | 149 |
| Table 13.91 | Turbidity recorded in the Olifantskop water treatment process on 26 June 2017 (Umgeni Water 2017: 10) | 150 |
| Table 13.92 | Water Schemes To Be Incorporated Into Proposed Okhahlamba RWSS | 159 |
| Table 13.93 | Water Schemes To Be Incorporated Into Proposed Alfred Duma RWSS..... | 160 |
| Table 13.94 | Water Schemes To Be Incorporated Into Proposed Inkosi Langalibalele RWSS | 162 |
| Table 13.95 | Cost estimates for refurbishment of uTDM WTPs..... | 167 |
| Table 13.96 | Active WSIG Projects of uTDM (personal communication DWS, March 2020)..... | 168 |
| Table 13.97 | Active MIG Projects of uTDM (personal communication, CoGTA, June 2020)..... | 168 |
| Table 13.98 | Tugela Ferry Population and Water Demand Projections | 169 |

LIST OF ACRONYMS

| | |
|---------------|---|
| AADD | Annual Average Daily Demand |
| AC | Asbestos Cement |
| ADWF | Average Dry Weather Flow |
| API | Antecedent Precipitation Index |
| AsgiSA | Accelerated and Shared Growth Initiative of South Africa |
| AVGF | Autonomous Valveless Gravity Filter |
| BID | Background Information Document |
| BPT | Break Pressure Tank |
| BWL | Bottom Water Level |
| BWSP | Bulk Water Services Provider |
| BWSS | Bulk Water Supply Scheme |
| CAPEX | Capital Expenditure |
| cl | class (of pipe) |
| CMA | Catchment Management Agency |
| CoGTA | Department of Co-operative Governance and Traditional Affairs |
| CWSS | Community Water Supply and Sanitation project |
| DAEA | Department of Agriculture and Environmental Affairs |
| DEA | Department of Environmental Affairs |
| DFA | Development Facilitation Act (65 of 1995) |
| DM | District Municipality |
| DMA | District Management Area |
| DRDLR | Department of Rural Development and Land Reform |
| DWA | Department of Water Affairs |
| DWS | Department of Water and Sanitation |
| DWAF | Department of Water Affairs and Forestry |
| EFR | Estuarine Flow Requirements |
| EIA | Environmental Impact Assessment |
| EKZN Wildlife | Ezemvelo KZN Wildlife |
| EMP | Environmental Management Plan |
| EWS | eThekweni Water Services |
| EXCO | Executive Committee |
| FC | Fibre Cement |
| FL | Floor level |
| FSL | Full Supply level |
| GCM | General Circulation Model |
| GDP | Gross Domestic Product |
| GDPR | Gross Domestic Product of Region |
| GVA | Gross Value Added |
| HDI | Human Development Index |

| | |
|--------|--|
| HL | High Lift (reference to Pump Station) |
| IDP | Integrated Development Plan |
| IFR | In-stream Flow Requirements |
| IMP | Infrastructure Master Plan |
| IMQS | Infrastructure Management Query Statement |
| IRP | Integrated Resource Plan |
| ISP | Internal Strategic Perspective |
| IWRM | Integrated Water Resources Management |
| KZN | KwaZulu-Natal |
| LM | Local Municipality |
| LUMS | Land Use Management System |
| MA | Moving Average |
| MAP | Mean Annual Precipitation |
| MAR | Mean Annual Runoff |
| MBR | Membrane Bioreactor |
| MMTS | Mooi-Mgeni Transfer Scheme |
| MMTS-1 | Mooi-Mgeni Transfer Scheme Phase 1 |
| MMTS-2 | Mooi-Mgeni Transfer Scheme Phase 2 |
| mPVC | Modified Polyvinyl Chloride |
| MTEF | Medium-Term Expenditure Framework |
| MTSF | Medium-Term Strategic Framework |
| MWP | Mkomazi Water Project |
| MWP-1 | Mkomazi Water Project Phase 1 |
| N/A | Not Applicable |
| NCP-1 | North Coast Pipeline I |
| NCP-2 | North Coast Pipeline II |
| NCSS | North Coast Supply System |
| NGS | Natal Group Sandstone |
| NPV | Net Present Value |
| NSDP | National Spatial Development Perspective |
| NWSP | National Water Sector Plan |
| OPEX | Operating Expenditure |
| p.a. | Per annum |
| PES | Present Ecological Status |
| PEST | Political, Economical, Sociological and Technological |
| PGDS | Provincial Growth and Development Strategy |
| PPDC | Provincial Planning and Development Commission (KZN's) |
| PS | Pump Station |
| PSEDS | Provincial Spatial Economic Development Strategy |
| PWSP | Provincial Water Sector Plan |
| RCC | Roller Compacted Concrete |

| | |
|---------|--|
| RDP | Reconstruction and Development Programme |
| Res | Reservoir |
| RO | Reverse Osmosis |
| ROD | Record of Decision |
| RQO | Resource Quality Objective |
| SCA | South Coast Augmentation |
| SCP | South Coast Pipeline |
| SCP-1 | South Coast Pipeline Phase 1 |
| SCP-2a | South Coast Pipeline Phase 2a |
| SCP-2b | South Coast Pipeline Phase 2b |
| SDF | Spatial Development Framework |
| SHR | St Helen's Rock (near Port Shepstone) |
| STEEPLE | Social/demographic, Technological, Economic, Environmental (Natural), Political, Legal and Ethical |
| SWRO | Seawater Reverse Osmosis |
| TEC | Target Ecological Category |
| TBC | To Be Confirmed |
| TBM | Tunnel Boring Machine |
| TLC | Transitional Local Council |
| TWL | Top Water Level |
| uPVC | Unplasticised Polyvinyl Chloride |
| UW | Umgeni Water |
| WA | Western Aqueduct |
| WC | Water Conservation |
| WDM | Water Demand Management |
| WMA | Water Management Area |
| WRC | Water Research Commission |
| WSA | Water Services Authority |
| WSDP | Water Services Development Plan |
| WSNIS | Water Services National Information System |
| WSP | Water Services Provider |
| WSS | Water Supply Scheme |
| WTP | Water Treatment Plant |
| WWW | Wastewater Works |

Spellings of toponyms have been obtained from the Department of Arts and Culture (DAC). DAC provides the official spelling of place names and the spellings, together with the relevant gazette numbers, can be accessed at <http://www.dac.gov.za/content/toponymic-guidelines-map-and-other-editors>.

When using any part of this report as a reference, please cite as follows:

Umgeni Water, 2020. *Umgeni Water Infrastructure Master Plan 2020/2021 – 2050/51, Vol 1 - 10*.

Prepared by Planning Services, June 2020.

LIST OF UNITS

| | | |
|-----------------------------|---|--------------------------------|
| Length/Distance: | mm | millimetre |
| | m | metre |
| | km | kilometre |
| Area: | m ² | square metres |
| | ha | hectare |
| | km ² | square kilometres |
| Level/Altitude: | mASL | metres above sea-level |
| Time: | s | second |
| | min | minute |
| | hr | hour |
| Volume: | <i>ℓ</i> | litre |
| | m ³ | cubic metres |
| | Mℓ | megalitre |
| | million m ³ | million cubic metres |
| | mcm | million cubic metres |
| | kl | kilolitre |
| | Water Use/Consumption/Treatment/Yield: | <i>ℓ</i> /c/day |
| | kl/day | kilolitre per day |
| | Mℓ/day | megalitre per day |
| | million m ³ /annum | million cubic metres per annum |
| | kg/hr | kilograms per hour |
| Flow velocity/speed: | m/s | metres per second |
| Flow: | m ³ /s | cubic metres per second |
| | <i>ℓ</i> /hr | litres per hour |
| | m ³ /hr | cubic metres per hour |

13. UPPER UTHUKELA SYSTEM

13.1 Synopsis of Upper uThukela System

The uThukela River, the largest river in KwaZulu-Natal (KZN), originates in the Mont-Aux-Sources of the Drakensberg Mountains (the source of the Orange and Vaal Rivers as well) and flows approximately 502 km through the KZN Midlands into the Indian Ocean. With a total catchment area of approximately 29 100 km², the uThukela River supplies the following economic regions (**Figure 2.80** in **Section 2** in **Volume 1**; **Figure 13.1**; **Figure 13.2**):

- Water from the upper reaches supply the Gauteng region (Thukela-Vaal Scheme);
- Water from the Mooi River, a tributary of the uThukela River supplies the Durban-Pietermaritzburg region (Mooi-Mgeni Transfer Scheme, see **Section 7** in **Volume 2**);
- Water from the Lower uThukela supplies the North Coast area (Lower Thukela Bulk Water Supply Scheme, see **Section 12** in **Volume 5**);
- Water from the Lower uThukela further augments the Richard's Bay area.

The uThukela catchment consists of the following water resource regions (**Figure 13.2**):

- Upper uThukela;
- Bushmans;
- Mooi;
- Sundays;
- Buffalo;
- Middle uThukela; and
- Lower uThukela.

Umgeni Water currently does not operate infrastructure in the Buffalo and Middle uThukela Water Resource Regions. The Lower uThukela Water Resource Region is discussed in **Section 12** in **Volume 5** and the Mooi water resource region in **Section 7** in **Volume 2**.

The Upper uThukela System consists of the Upper uThukela, Bushmans and Sundays Water Resource Regions (**Figure 13.3**), and settlements including Ladysmith, Ezakheni, Ekuvukeni, Limehill, Estcourt, Bergville, Winterton, Colenso, Weenen, Mkukuwini and Langkloof are supplied from this system. The Water Treatment Plants (WTPs) supplying these settlements are shown in **Figure 13.3** and **Figure 13.4**. It is further shown in **Figure 13.3** and **Figure 13.4** that Umgeni Water currently operates the Ezakheni WTP, the Tugela Estates WTP and the Olifantskop WTP. Umgeni Water started operating these three WTPs as of 1 October 2018.

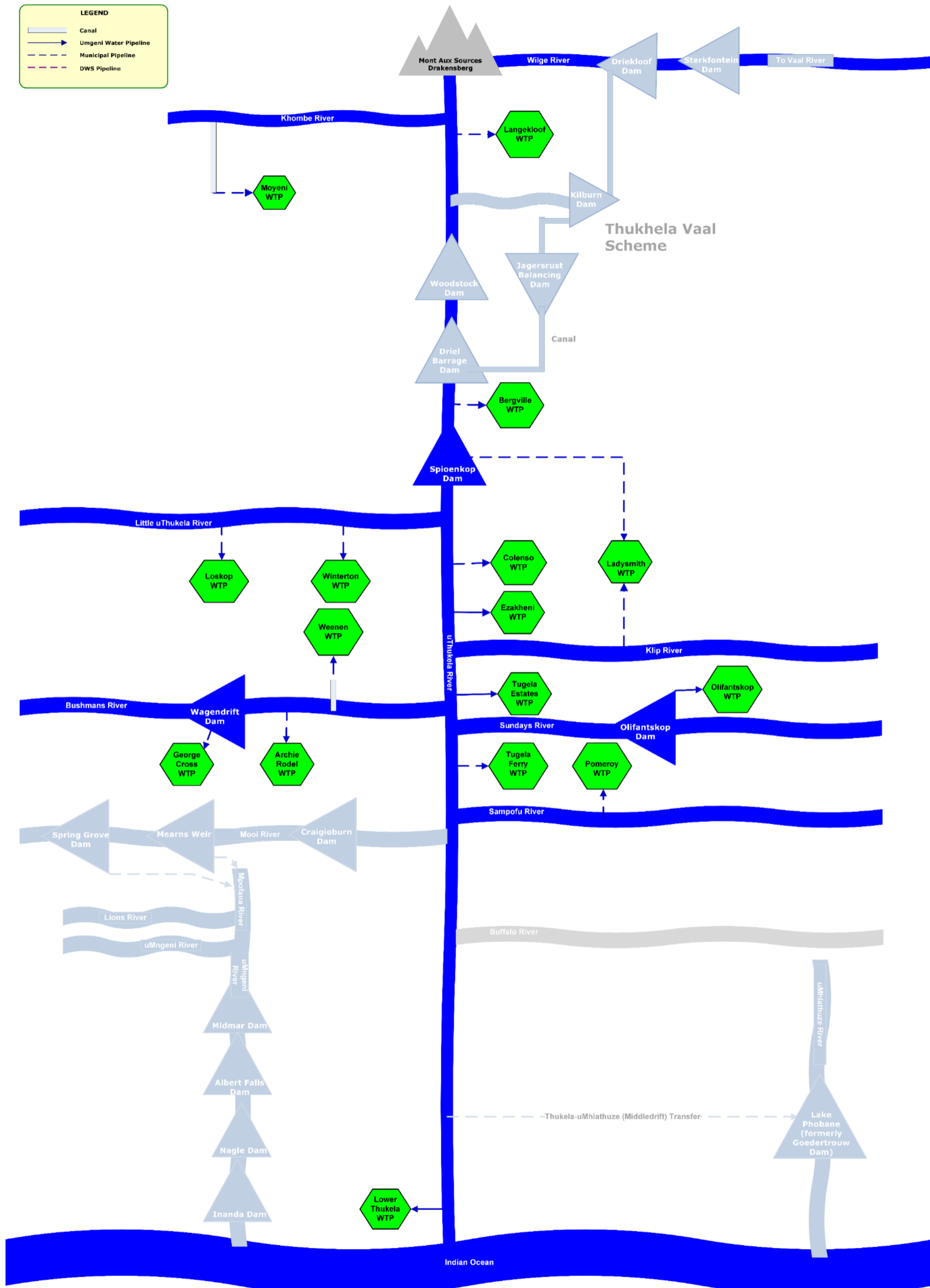

- Figure 13.1 Schematic of the uThukela River System with key abstractions (excluding the Buffalo River)

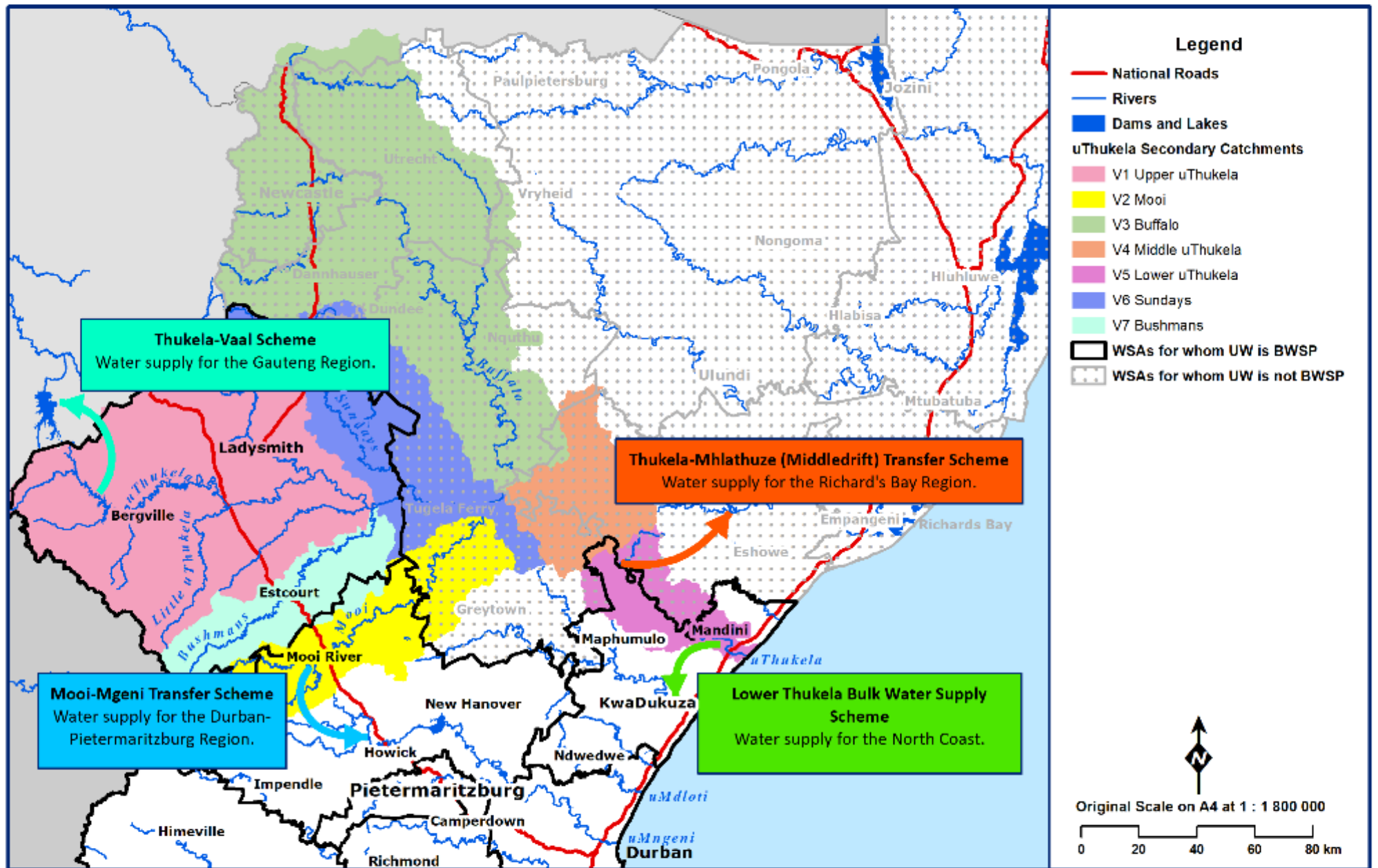

Figure 13.2 General layout of the uThukela River System (KZN DoT 2017, MDB 2016, Umgeni Water 2019, WR2012).

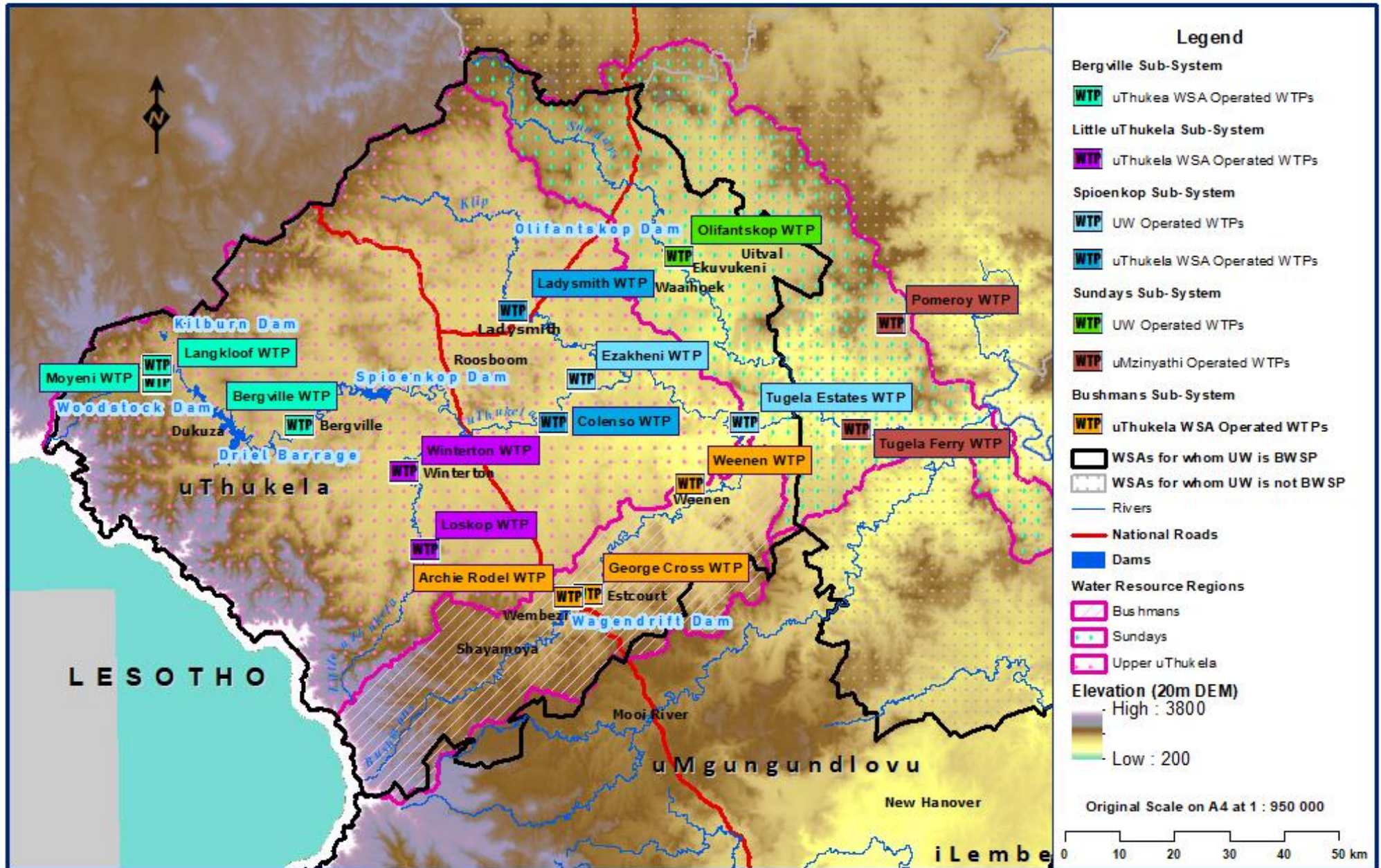
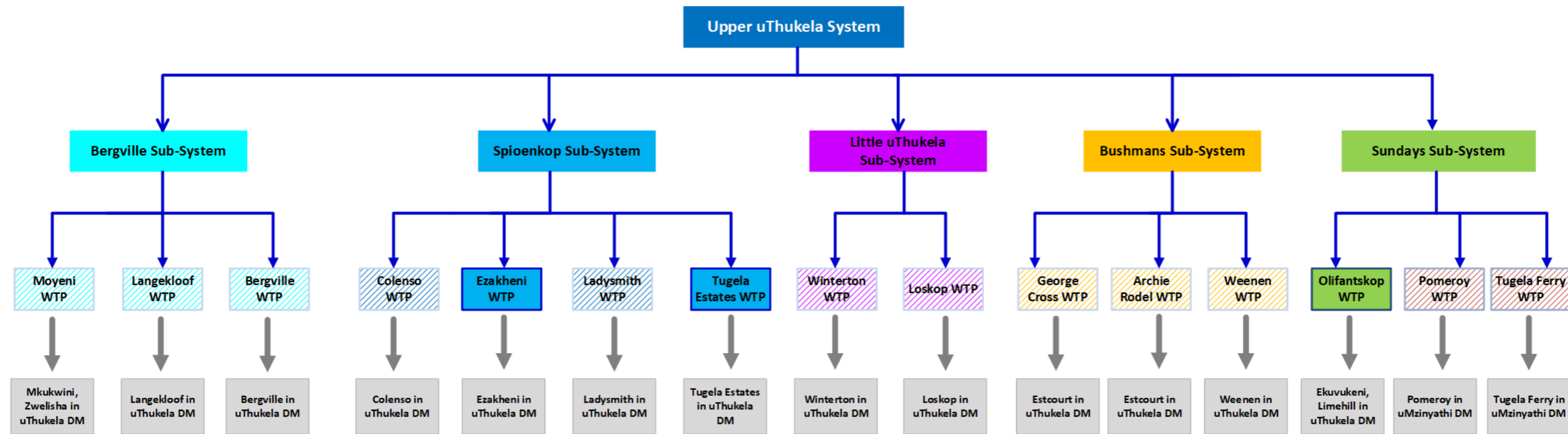

Figure 13.3 General layout of the Upper uThukela System (KZN DoT 2017, MDB 2016, Umgeni Water 2019, WR2012).



Legend

□ Not operated by Umgeni Water

□ Operated by Umgeni Water

Figure 13.4 Network chart of the Upper uThukela System.

13.2 Water Resources of the uThukela System

13.2.1 Description of the uThukela System Water Resource Regions

(a) Upper uThukela Region

(i) Overview

The Upper uThukela Region lies in the upper reaches of the uThukela River upstream of the confluence of Bushmans River, and includes the towns of Bergville, Ladysmith, Colenso and Weenen (**Figure 13.5**). The uThukela, Little uThukela and Klip River are the main rivers in this catchment. The Upper uThukela region is the source of water for uThukela-Vaal Transfer Scheme, which transfers water to the Vaal River System (DWA 2004: 26).

The Little uThukela River is utilised for abstraction of water to supply the Loskop and Winterton Water Supply Schemes (WSS). According to the uThukela WMA ISP (DWA 2004: 31), the river is mainly utilised for irrigation and water requirements already exceed the sustainable yield.

The lower part of this region (Little uThukela River area) is dominated by commercial agriculture. The many small farm dams and the Bell Park Dam are used for irrigation.

(ii) Surface Water

The uThukela-Vaal Transfer Scheme transfers 377 million m³/annum (DWA 2004: 26) from this area of the uThukela Catchment to the Vaal System. In addition, the recently constructed Ingula Pumped Storage Scheme (commissioned between 2016 and 2017) is a hydroelectric peaking power scheme developed to generate electricity on the Braamhoek River.

In 2004, the gross available surface water resource in the Upper uThukela Region was estimated to be between 553 and 570 million m³/annum, depending on where the water was being supplied (DWA 2004: 27).

The hydrological characteristics for this region are summarised in **Table 13.1** and it is shown that the Upper uThukela Region has the highest runoff in the entire uThukela Catchment. This can be attributed to the high elevation and rainfall area of the Drakensberg Mountains in the upper parts of the catchment.

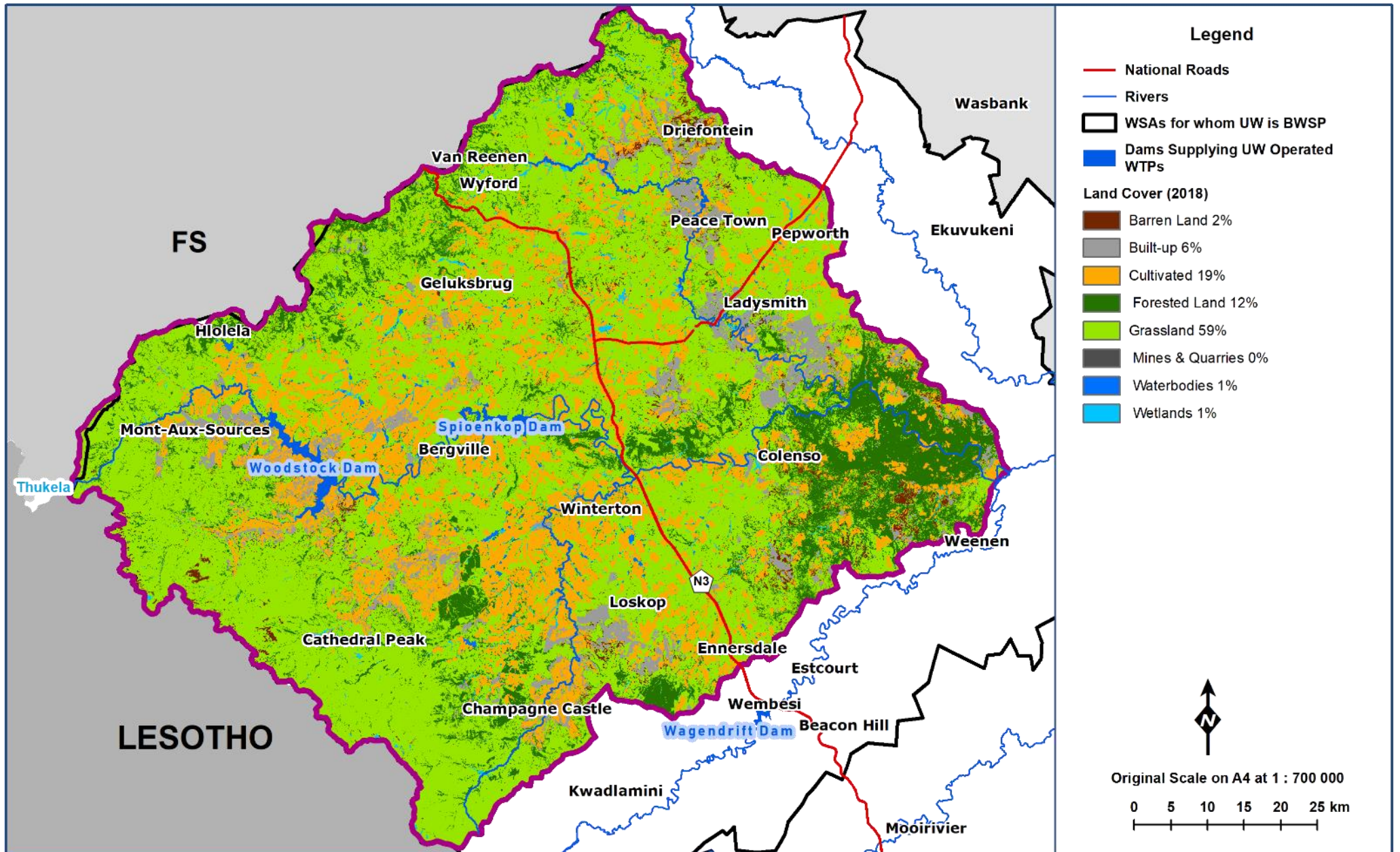

Figure 13.5 General layout of the Upper uThukela region (DEA and GTI 2015, KZN DoT 2017, MDB 2016, Umgeni Water 2019).

Table 13.1 Hydrological characteristics of the Upper uThukela Region (WR2012: Thukela Quat Info WMA 7 7Jul2015 spreadsheet).

| Region | River (Catchment) | Area (km ²) | Annual Average | | | |
|----------------|-----------------------|-------------------------|------------------|---------------|--|---------------------|
| | | | Evaporation (mm) | Rainfall (mm) | Natural Runoff (million m ³ /annum) | Natural Runoff (mm) |
| Upper uThukela | uThukela River (V11) | 2635 | 1352 | 1047 | 772.49 | 293.17 |
| Upper uThukela | Klip River(V12) | 2155 | 1453 | 820 | 230.42 | 106.92 |
| Upper uThukela | Little uThukela (V13) | 1347 | 1362 | 909 | 323.63 | 240.26 |
| Upper uThukela | uThukela (V14) | 1508 | 1459 | 735 | 127.54 | 84.58 |

(iii) Groundwater

The Upper uThukela region is located in the North Western Middelveld Hydrogeological Region (**Section 2 in Volume 1**). This Hydrogeological Region is characterised by intergranular and fractured aquifers with a low to medium development potential. The underlying geology is mostly arenaceous rock of the Ecca Formation.

- **Hydrogeological Units**

The region is underlain entirely by formations of the Karoo Supergroup which mainly comprise shales and sandstones of the Ecca and Beaufort Groups with extensive intrusions of dolerite sills and, to a lesser extent, dolerite dykes. The Ecca and Beaufort rocks are overlain by shales and sandstones of the Molteno, Elliot and Clarens Formations, and by the basalt of the Drakensberg Formation which forms the high ground along the western boundary of the area. Local minor outcrops of the Dwyka Formation occur in the eastern part of the area. Isolate deposits of Quaternary sediments, comprising the Masotcheni Formation, are found mainly along the main river courses.

- **Geohydrology**

Groundwater resources in the area are variable and dependent mainly on the presence of joints and fractures within various lithologies. Recharge for most of the area is in the range 15 mm to 20 mm per year (2% -3% of annual rainfall). Using the lower recharge estimate the available resource is 150 million m³/year.

The Karoo dolerites occur mainly as sills throughout the sequence of Karoo sediments in the area. The sills outcrop as horizontal to sub-horizontal sheets, but are also present at various depths below surface. It appears from borehole records that the sills generally vary from about 10 m to 50 m in thickness. The thinner sills tend to be more fractured and have greater groundwater potential

- **Groundwater Potential**

The shales in the area represent a secondary aquifer or fractured aquifer with reported borehole yields (median yields) falling within the moderate (> 0.5 to 3.0 ℓ/s) range. The dolerites located to the east and west however offer poor borehole yields in the low (> 0.1 to 0.5 ℓ/s) classification, confirming that the development potential in this lithology (**Figure 13.6**) can be classified as poor.

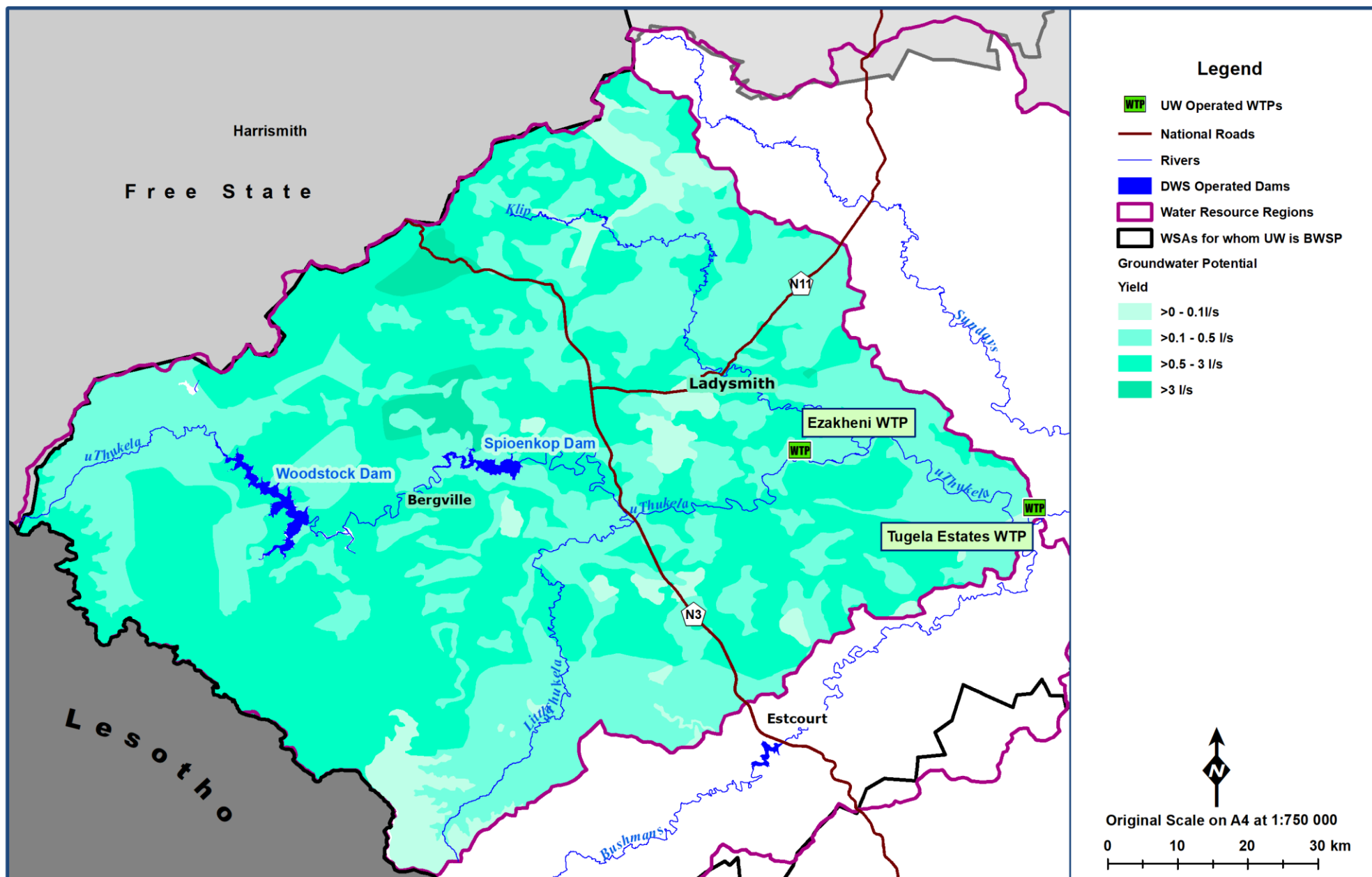

Figure 13.6 Groundwater potential in the Upper uThukela Region (KZN DoT 2017, MDB 2016, Umgeni Water 2019, WR2012).

(iv) Water Quality

• Surface Water

Routine catchment water quality monitoring is currently not undertaken by Umgeni Water in the Upper uThukela Region. However, raw water quality monitoring is undertaken as per process management and legislative requirements (SANS 241) at the Umgeni Water operated Ezakheni WTP, and Tugela Estates WTP. The resources water quality assessment presented in this section is therefore based on the available raw water quality data at these two WTPs. The water quality data was generated through the water quality monitoring programme instituted by Umgeni Water in 2019. The assessment is largely based on the Department of Water and Sanitation Guidelines for Aquatic Ecosystems and the Water Quality Field Guide^{1; 2}.

The raw water quality at the Ezakheni WTP and Tugela Estates WTP reflect elevated turbidity results (**Figure 13.7** and **Figure 13.8**). The recorded elevated turbidity results are largely due to erosion in the catchment. The elevated turbidity numbers are mainly recorded during the wet season reflecting the impact of rainfall related runoff. The catchment area is mainly rural and the land is utilised for livestock grazing and subsistence agriculture. Inadequate veld management within these areas means that erosion is a perpetual ecological impact, with the formation of deep gullies being noticeable throughout the region. The intermittent; sudden turbidity increases create challenges for the treatment process at times compromising drinking water compliance as the available treatment process infrastructure is also limiting.

The elevated *E. coli* numbers (**Figure 13.7** and **Figure 13.8**) also reflect challenges within the catchment. The recorded elevated numbers depict the existing sewage management inadequacies within the catchment. Elevated nutrients is one of the key inputs associated with sewage and agriculture related resource contamination. Although nutrients (i.e. TP, SRP, TKN & NH₃) are not currently monitored, the prevalence of sewage and agriculture related contamination confirms that nutrients are an on-going input into the resource. The impact of catchment challenges experienced in this region are also reflected by the water quality results recorded in the Lower Thukela Region elevated turbidity and *E. coli* results (**Section 12** in **Volume 5**).

The recorded water quality challenges will persist in the absence of improvement intervention within the catchment. Therefore, water treatment challenges will remain an on-going challenge that is also compounded by existing treatment infrastructure inadequacies.

¹ Department of Water Affairs and Forestry (DWAF). 1996. *South African Water Quality Guidelines. Volume 7: Aquatic Ecosystems*.

² Department of Water Affairs and Forestry (DWAF). 1996. *South African Water Quality Guidelines. Volume 8: Field Guide*.

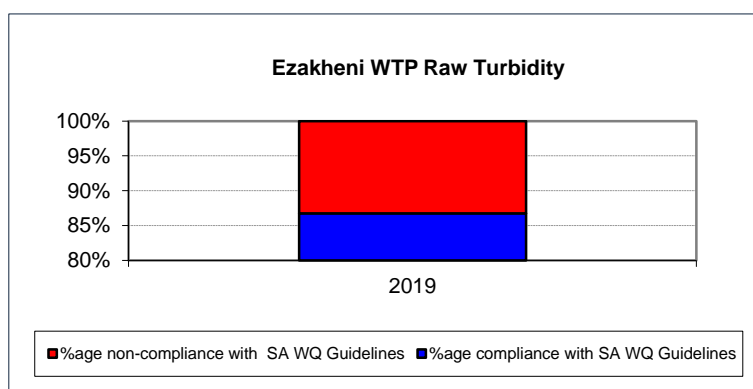
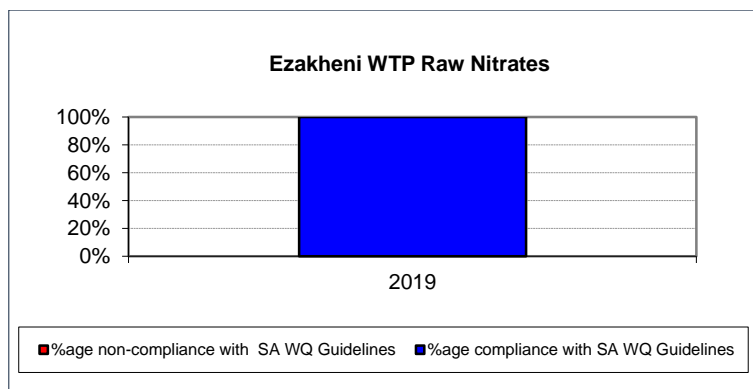
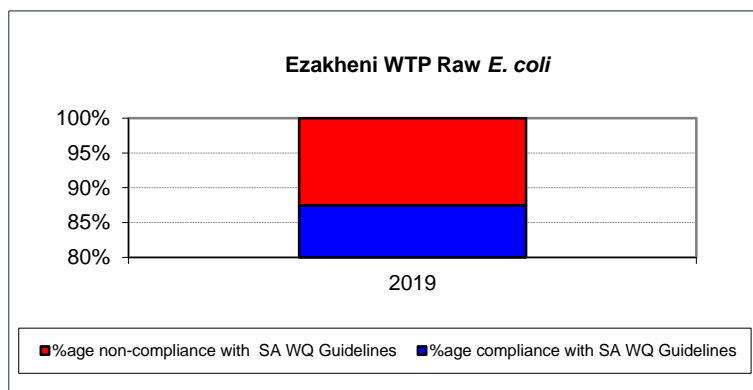
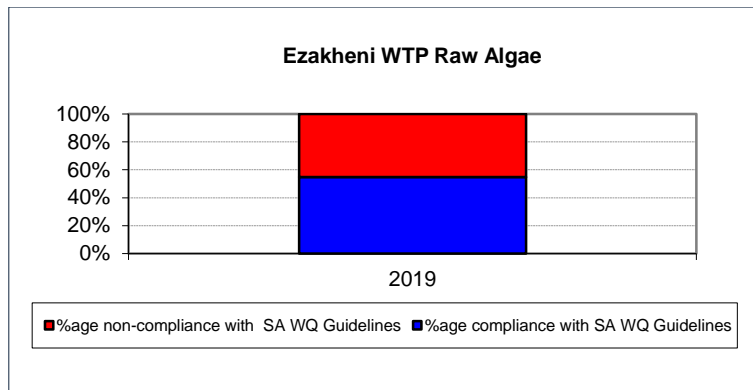

Figure 13.7 Percentage compliance vs. non-compliance with the South African Water Quality Guidelines for Ezakheni WTP.

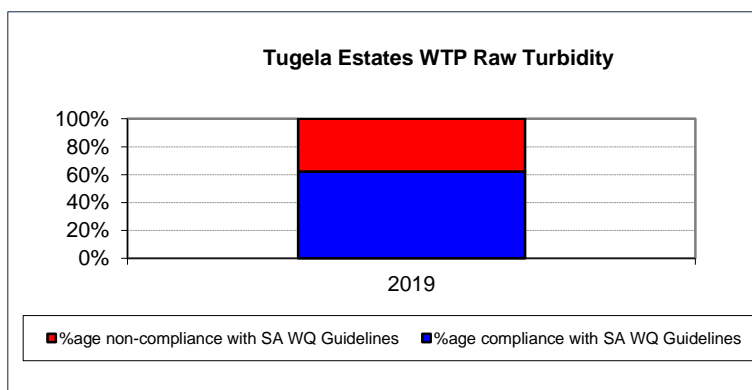
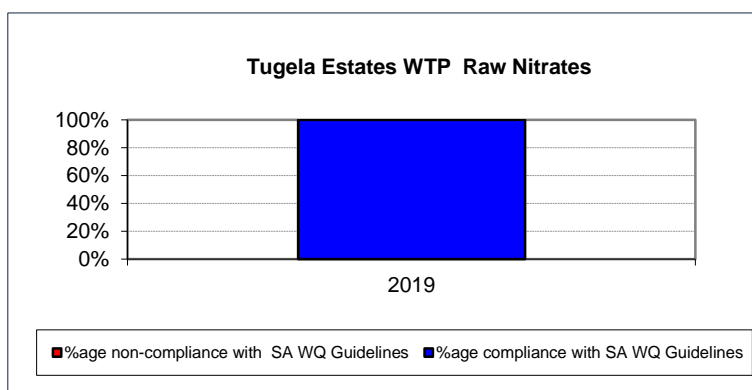
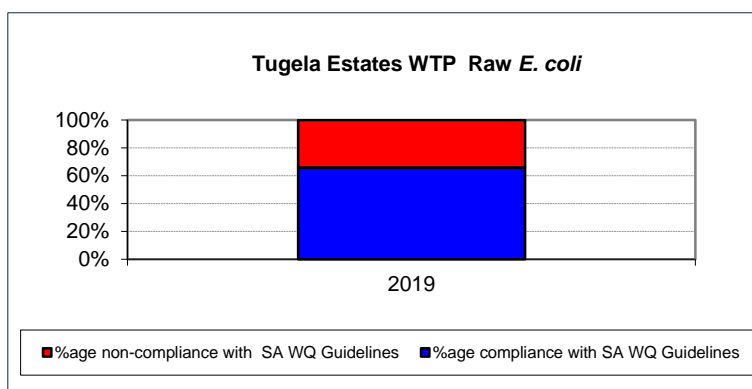
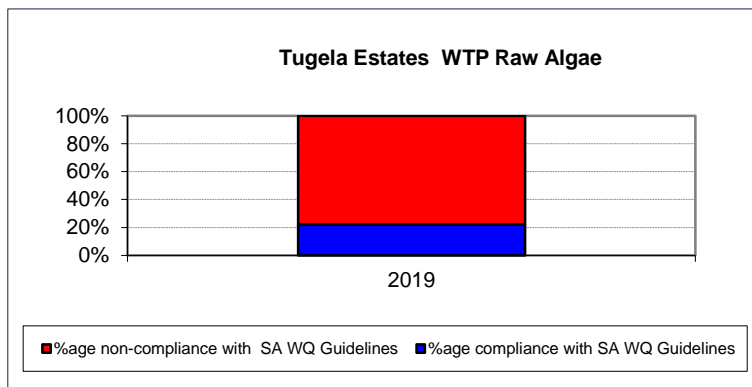

Figure 13.8 Percentage compliance vs. non-compliance with the South African Water Quality Guidelines for Tugela Estates WTP.

- **Groundwater**

The ambient water quality of groundwater in the area is generally good; being essentially Ca-HCO₃ (Calcium Bi-carbonate) and Ca – Na – HCO₃ water, with minor occurrences of sulphate, nitrate and chloride. Of boreholes sampled the chemical analysis generally complies with SANS 241 maximum permissible standards. The concentration of iron, however, tends to be higher than the SANS 241 permissible limits. Temporary hardness of the groundwater in the Weenen area has resulted in deposition of insoluble carbonates in pipework at this location.

The electrical conductivity levels range from 0 – 350 mS/m, although the bulk of the area ranges from 0 -150 mS/m. The conductivity levels increase towards the south –east of the study area, and localised high levels near Witbank.

Apart from the elevated conductivity near Witbank, a zone of relatively high conductivity (150 - 350 mS/m) occurs within a topographically low lying area extending from Ladysmith to Greytown. The highest conductivity levels (300 – 350 mS/m) are found near Greytown.

The elevated conductivity levels are often associated with high levels of salts in solution, such as sodium and chloride, and to a lesser extent calcium and magnesium. The groundwater generally contains more calcium than magnesium.

The saline nature of the groundwater is possibly ascribed to a relatively saline depositional environment.

(b) Bushmans Region

(i) Overview

The source of the Bushman's River, in the Drakensberg Mountain range, is in the neighbouring uMgungundlovu District Municipality. This river originates in the southern part of the uThukela District Municipality (quaternary catchment V70A) and flows in a north-easterly direction past the town of Estcourt to join the uThukela River near the town of Weenen. There are also significant traditional areas between Estcourt and Weenen (DWA 2004: 23, Umgeni Water 2016: 38).

The Bushmans River is the only main river in this region. The Bushmans Region general layout is shown in **Figure 13.9**.

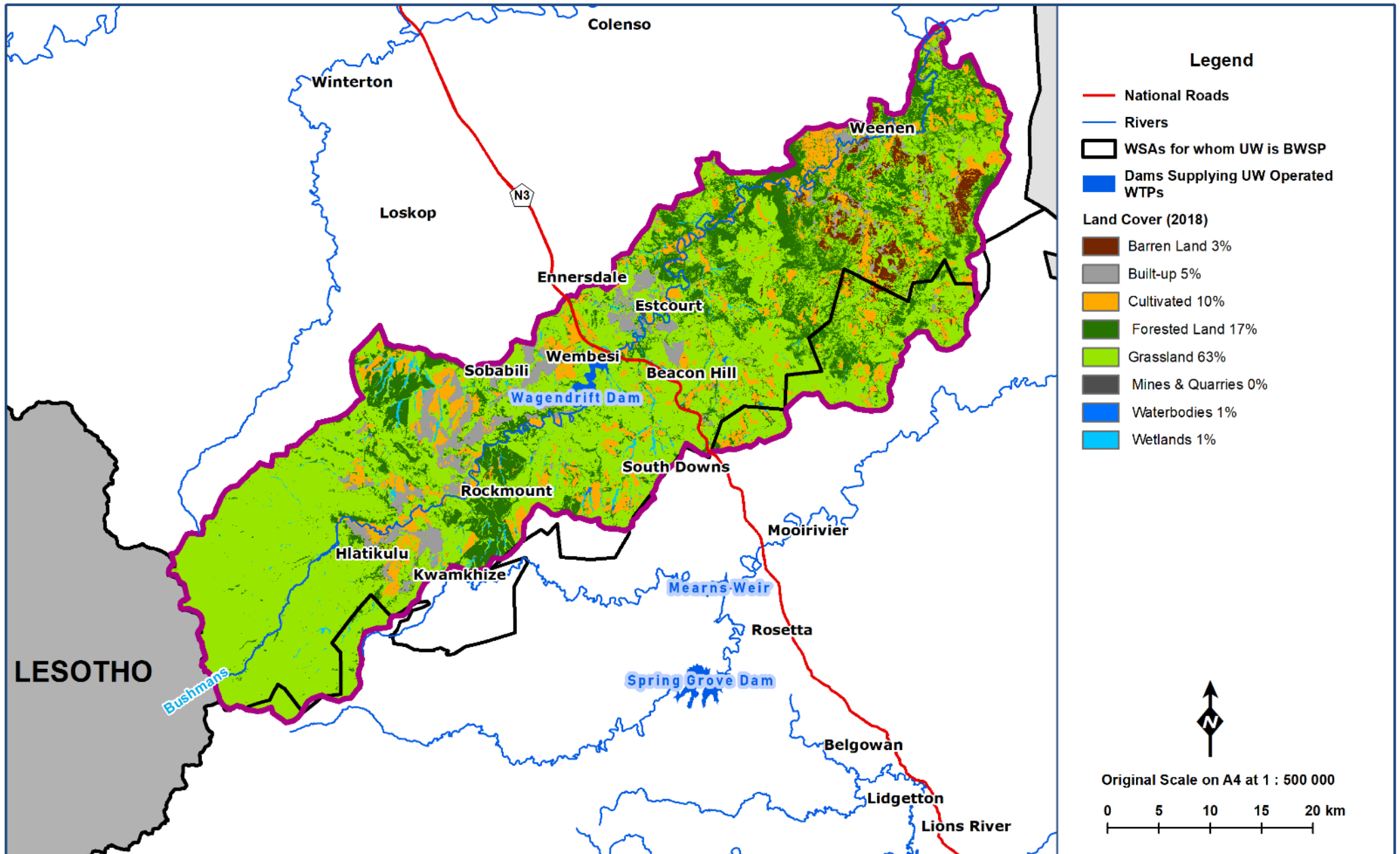

Figure 13.9 General layout of the Bushmans Region (DEA and GTI 2015, KZN DoT 2017, MDB 2016, Umgeni Water 2019).

(ii) Surface Water

In 2004, the gross available water resource for the Bushmans River was estimated to be 115 million m³/annum (DWAF 2004). This region has relatively high evaporation rates and runoff (DWAF 2004: 35).

The hydrological characteristics for this region are summarised in **Table 13.2**.

Table 13.2 Hydrological characteristics of the Bushmans Region (WR2012: Thukela Quat Info WMA 7 7Jul2015 spreadsheet).

| Region | River (Catchment) | Area (km ²) | Annual Average | | | |
|-----------------|---------------------|-------------------------|------------------|---------------|--|---------------------|
| | | | Evaporation (mm) | Rainfall (mm) | Natural Runoff (million m ³ /annum) | Natural Runoff (mm) |
| Bushmans Region | Bushmans River(V70) | 1 917 | 1 362 | 825 | 307.94 | 160.64 |

(iii) Groundwater

The Bushmans region is located in the North Western Middelveld Hydrogeological Region (**Section 2 in Volume 1**). This Hydrogeological Region is characterised by intergranular and fractured aquifers with a low to medium development potential. The underlying geology is mostly arenaceous rock of the Ecca Formation.

• Hydrogeological Units

The region is underlain entirely by formations of the Karoo Supergroup which mainly comprise shales and sandstones of the Ecca and Beaufort Groups with extensive intrusions of dolerite sills and, to a lesser extent, dolerite dykes. The Ecca and Beaufort rocks are overlain by shales and sandstones of the Molteno, Elliot and Clarens Formations, and by the basalt of the Drakensberg Formation which forms the high ground along the western boundary of the area.

• Geohydrology

The demand on groundwater is largely confined to the plateau areas below the foothills of the Drakensberg. This plateau is generally underlain by shales and mudstones of the Karoo Supergroup. These lithologies typically support marginal to poor borehole yields. However, the presence of extensive intrusive dolerite in the form of sheets and dykes has greatly enhanced the potential of the mudstones to store and yield groundwater. The effect of brittle fracturing and crushing of the shales and mudstones along the contact zone with the intrusive dolerites provides the necessary secondary porosity and permeability for groundwater storage and movement in these lithologies.

• Groundwater Potential

Yields in the area range from 0.1 to 0.5 ℓ/s (**Figure 13.10**) so the groundwater potential can be considered low. The exceptions are boreholes located in extensive thicknesses of dolerite where contact zones of the host lithologies are not intercepted and where yields are typically < 0.1 ℓ/s.

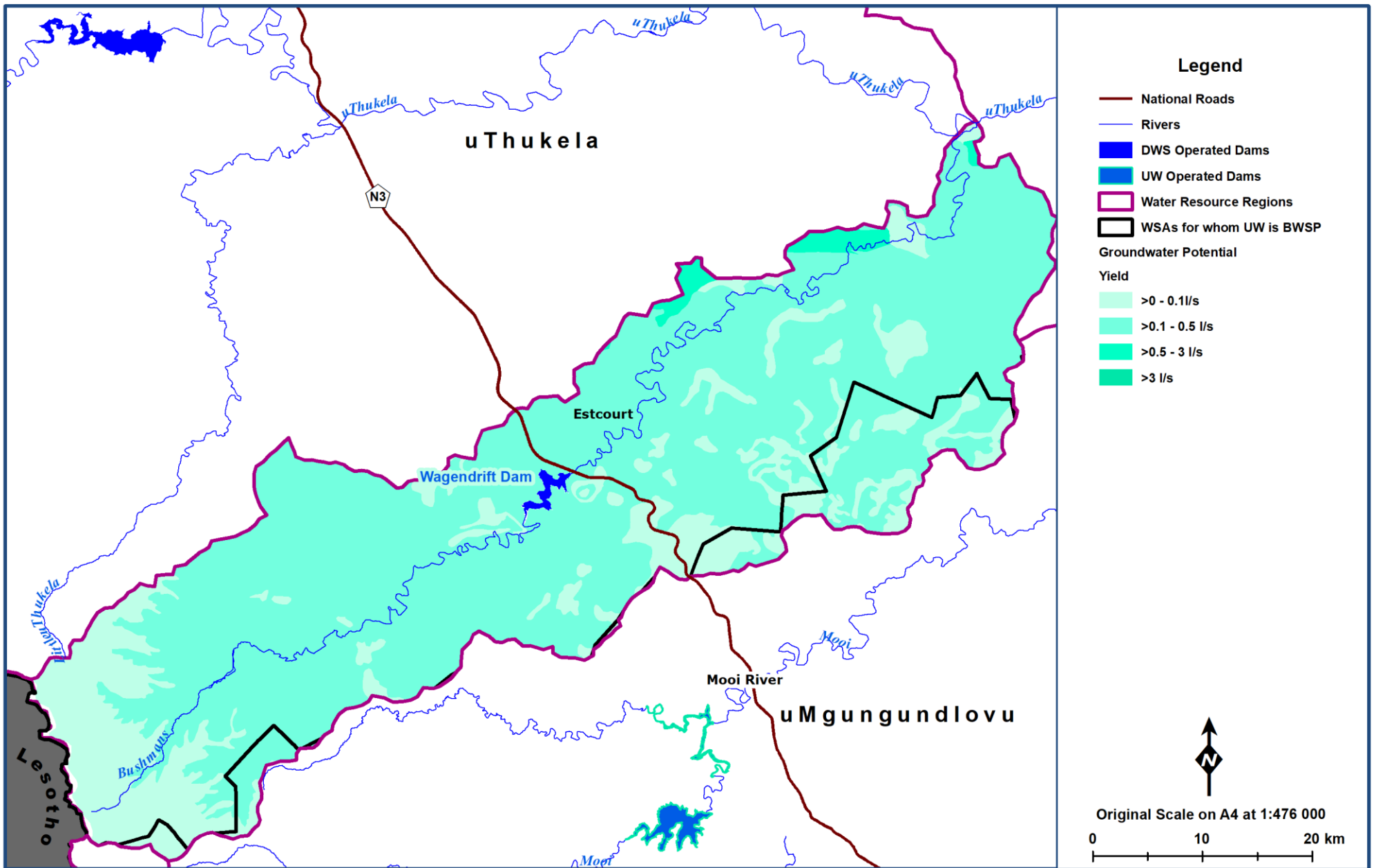

Figure 13.10 Groundwater potential in the Bushmans Region (KZN DoT 2017, MDB 2016, Umgeni Water 2019, WR2012).

(iv) Water Quality

- Surface Water

Umgeni Water currently does not operate infrastructure in the Bushmans region and therefore there is no surface water quality data available for this version of the IMP.

- Groundwater

The shales of the Karoo Supergroup are characterised by alkaline groundwater with sub-equal proportions of the major cations, although slightly higher levels of sodium and potassium are ascribed to leaching from the country rock. Low levels of all major anions are seen to occur, with sulphate noted as being the most dominant. pH levels and electrical conductivity levels range from 7.5 – 8.8 and 10 – 100 mS/m respectively. According to the SANS 241 (2015) standard for potable water, the mean values of the major chemical determinants would be classified as ideal.

(c) Sundays Region

(i) Overview

The Sundays River flows in a south-easterly direction from the eastern escarpment to its confluence with the uThukela River near the Bushmans River confluence (**Figure 13.11**). The Sundays River is regulated with the Slangdraai Dam and Oliphantskop Dam, the main storage dams in the catchment. With a storage capacity of 10.3 million m³/annum, it has been estimated that the Slangdraai Dam has a historical gross yield of approximately 6.14 million m³/annum (DWA 2004: 37).

The Oliphantskop Dam is located on the Sundays River, approximately 8 km west of Ekuvukeni. The estimated full storage capacity of the dam is 1.45 million m³ (DWA 2012). The available water in the Sundays River system is estimated to be 8 million m³/annum after taking into account environmental water requirements. The Oliphantskop Dam (quaternary catchment V60C), is used as a water source for the Ekuvukeni Lime Hill WSS (DWA 2004: 37).

(v) Surface Water

Based on the ISP 2004, the gross available water in the Sundays River, is estimated to be 12 million m³/annum (DWA 2004: 37).

The hydrological characteristics for this region are summarised in **Table 13.3**.

Table 13.3 Hydrological characteristics for the Sundays region (WR2012: Thukela Quat Info WMA 7 7Jul2015 spreadsheet).

| Region | River (Catchment) | Area (km ²) | Annual Average | | | |
|---------|-------------------|-------------------------|------------------|---------------|--|---------------------|
| | | | Evaporation (mm) | Rainfall (mm) | Natural Runoff (million m ³ /annum) | Natural Runoff (mm) |
| Sundays | Sundays (V60) | 3711 | 1466 | 749 | 313.34 | 84.44 |

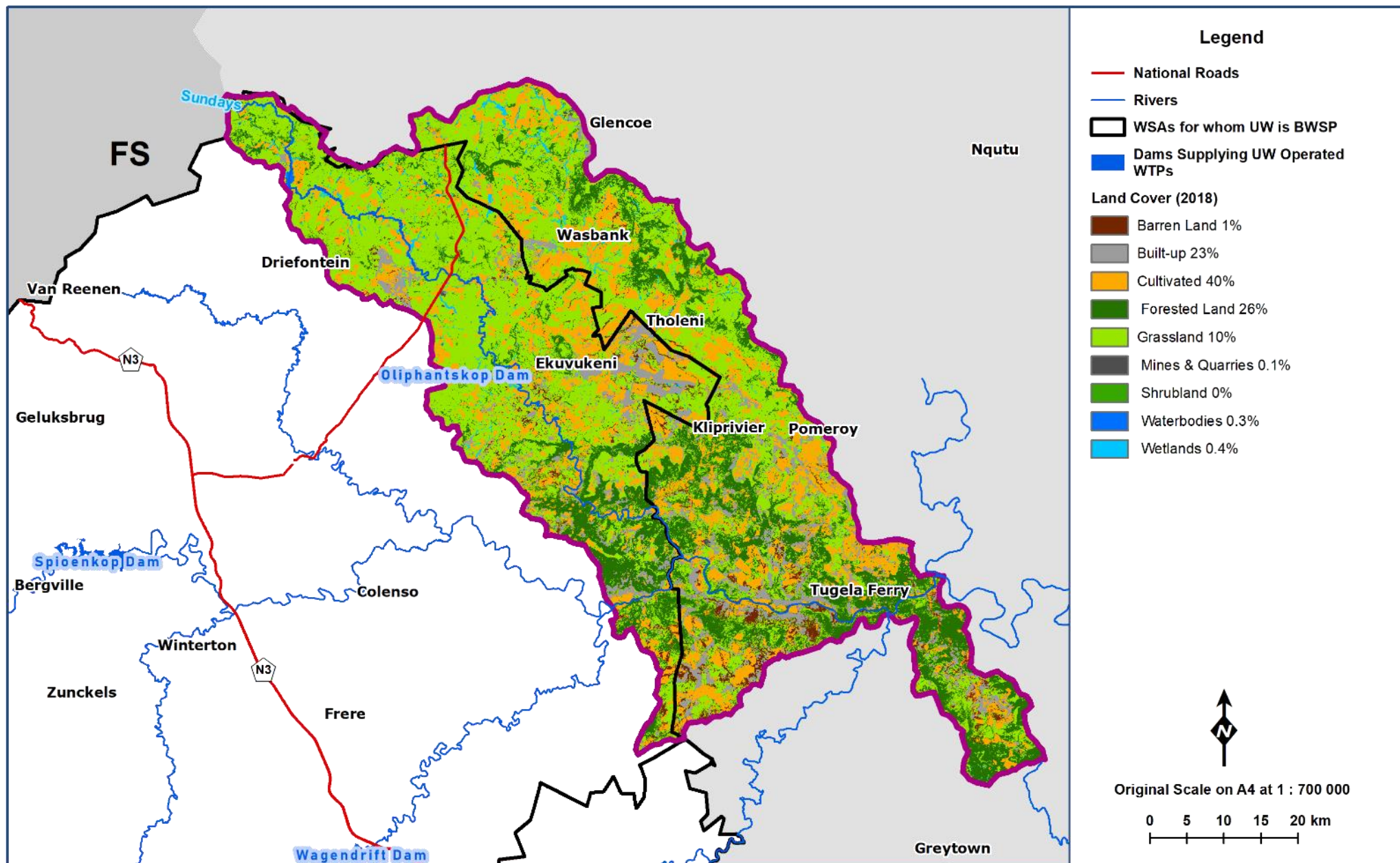

Figure 13.11 General layout of the Sundays Region (DEA and GTI 2015, KZN DoT 2017, MDB 2016, Umgeni Water 2019).

(vi) Groundwater

The Sundays Region is located in the North Western Middelveld Hydrogeological Region (**Section 2 in Volume 1**). This Hydrogeological Region is characterised by intergranular and fractured aquifers with a low to medium development potential. The underlying geology is mostly arenaceous rock of the Ecca Group.

• Hydrogeological Units

The region is mostly underlain by the Karoo Supergroup. Parsons and Conrad (1998) classify the aquifers in the study area as minor aquifers with moderate to low vulnerability to anthropogenic impacts. The Vryheid Formation (of the Ecca Group) comprises mudrock, rhythmite, siltstone and fine- to coarse-grained sandstone (pebbly in places).

Sills in the Karoo formations are sheet like forms of dolerite intrusions that tend to follow the bedding planes of the formations concordantly. These structures, whose thicknesses vary from less than a metre to hundreds of metres, represent the dominant form in which dolerite is emplaced in the Karoo Supergroup. Dolerite sills in the Karoo Supergroup often have very complex forms.

• Geohydrology

Aquifers within the region include:

- Weathered and fractured hard rock aquifer systems.
- Primary aquifers that are confined to a narrow strip along the middle reaches of the Sundays River.

Groundwater recharge over the region varies from 1 to 5 % of the mean annual precipitation (MAP), with an average of about 3 percent of the MAP. Overall, the average annual recharge over the region is some 25 000 m³/km².

• Groundwater Potential

Groundwater yields from 'hard-rock' boreholes in the region are generally low and in the range 0.1 to 0.6 ℓ/s (**Figure 13.12**), although significantly higher yields (3 ℓ/s) can be obtained in hydrogeologically favourable situations, such as fracturing and intrusive Karoo dolerite contact zones. Contacts between different lithologies were also seen to be important drilling targets. There is little difference in yield among the various geological formations.

Higher borehole yields can be obtained in some localities. Juxtaposition of sandstone horizons to dolerite, major structural features such as faults and fractures and more competent Natal Group quartzites and sandstones have produced borehole yields in excess of 2 ℓ/s. The likelihood of obtaining yields in excess of 2 ℓ/s, however, is less than 30%, while few boreholes yield more than 3 ℓ/s.

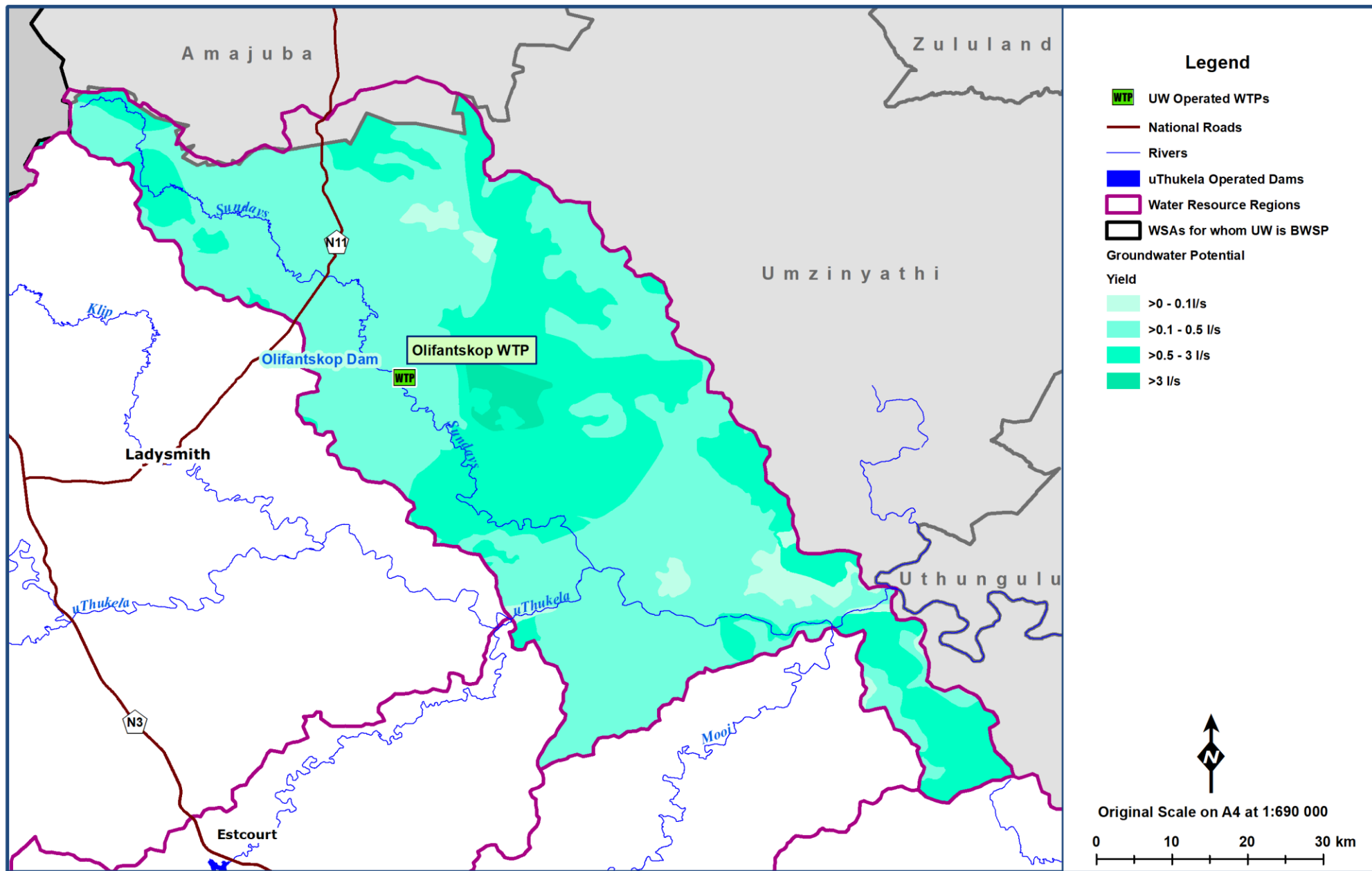

Figure 13.12 Groundwater potential in the Sundays Region (KZN DoT 2017, MDB 2016, Umgeni Water 2019, WR2012).

(vii) Water Quality

• Surface Water

Similar to the Upper uThukela Region (**Section 13.2.1 (a)(iv)**), routine catchment water quality monitoring is currently not undertaken by Umgeni Water in the Sundays Region. Raw water quality monitoring is undertaken as per process management and legislative requirements (SANS 241) at the Umgeni Water operated Olifantskop WTP. The resources water quality assessment presented in this section is therefore based on the available raw water quality data at this WTP. The water quality data was generated through the water quality monitoring programme instituted by Umgeni Water in 2019. The assessment is largely based on the Department of Water and Sanitation Guidelines for Aquatic Ecosystems and the Water Quality Field Guide^{3,4}.

The raw water quality at the Olifantskop WTP shows elevated turbidity results (**Figure 13.13**). The recorded elevated turbidity results are largely due to erosion in the catchment. The elevated turbidity numbers are mainly recorded during the wet season reflecting the impact of rainfall related runoff. The catchment area is mainly rural and the land is utilised for livestock grazing and subsistence agriculture. Inadequate veld management within these areas means that erosion is a perpetual ecological impact, with the formation of deep gullies being noticeable throughout the region. The intermittent; sudden turbidity increases create challenges for the treatment process at times compromising drinking water compliance as the available treatment process infrastructure is also limiting.

The elevated *E. coli* numbers (**Figure 13.13**) also reflect challenges within the catchment. The recorded elevated numbers depict the existing sewage management inadequacies within the catchment. Elevated nutrients is one of the key inputs associated with sewage and agriculture related resource contamination. Although nutrients (i.e. TP, SRP, TKN & NH₃) are not currently monitored, the prevalence of sewage and agriculture related contamination confirms that nutrients are an on-going input into the resource.

The recorded water quality challenges will persist in the absence of improvement intervention within the catchment. Therefore, water treatment challenges will remain an on-going challenge that is also compounded by existing treatment infrastructure inadequacies.

³ Department of Water Affairs and Forestry (DWAF). 1996. *South African Water Quality Guidelines. Volume 7: Aquatic Ecosystems*.

⁴ Department of Water Affairs and Forestry (DWAF). 1996. *South African Water Quality Guidelines. Volume 8: Field Guide*.

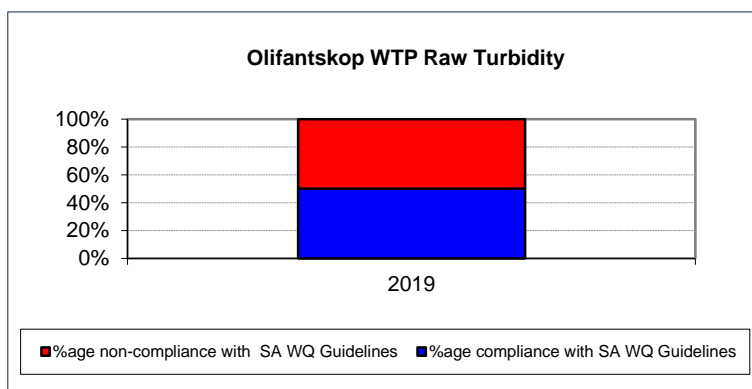
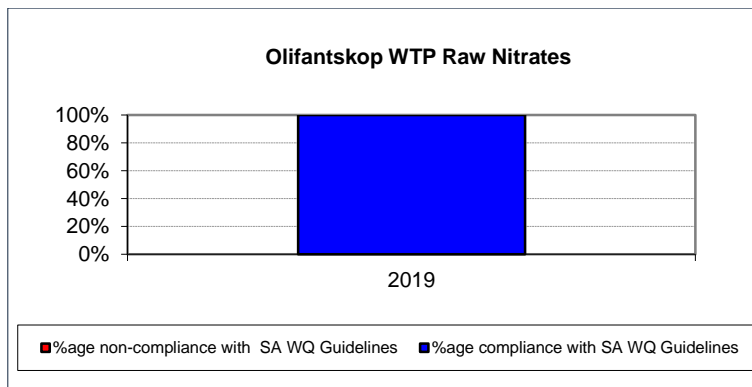
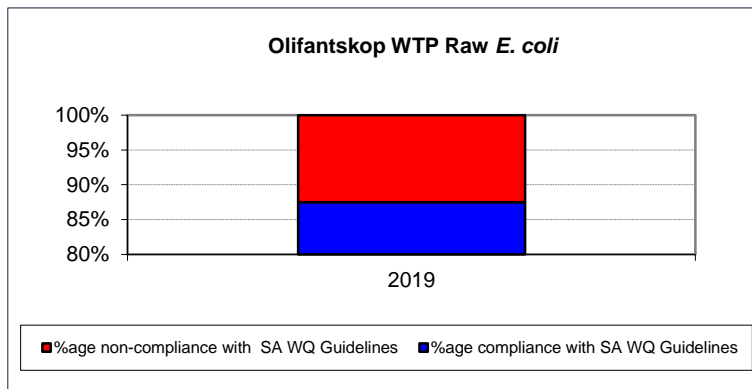
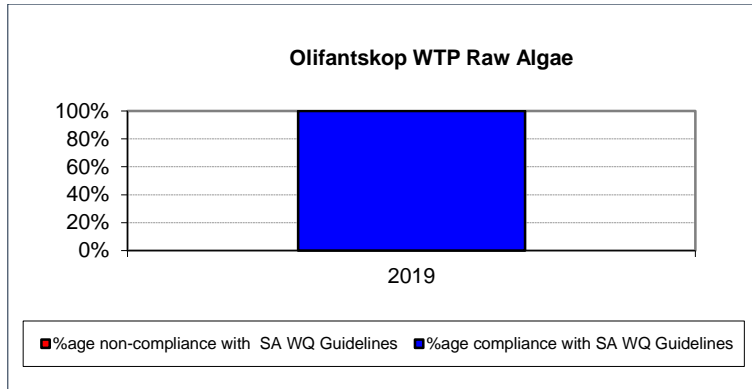

Figure 13.13 Percentage compliance vs. non-compliance with the South African Water Quality Guidelines for Olifantskop WTP.

- **Groundwater**

Groundwater quality deteriorates in the direction of flow and assumes a more dominant N-Cl character. Groundwater quality in the region is generally good, with the best quality groundwater found in the higher rainfall portions, and the poorest quality in the lower rainfall areas. The electrical conductivity of the groundwater is generally in the range 8 to 33 mS/m, but this can rise to considerably more than 70 mS/m in the lower rainfall portions of the region with a low to medium development potential.

13.2.2 Reserve

(a) Upper uThukela Region

As stated in **Section 12.2.2 (a) in Volume 5**, the uThukela Region was not part of the DWS 2016 study to determine the Ecological Reserve and the Resource Quality Objectives. Water for the Ecological Reserve is water that must remain in the river and may not be abstracted. This results in a reduction in yield available for supply. The Reserve Classification Study of uThukela WMA was commissioned by DWS in February 2020. This study is critical to ensure that water resources in the region are able to sustain their level of uses and be maintained at their desired states.

The determination of the water resource classes of the significant water resources in uThukela WMA will ensure that the desired condition of the water resources, and conversely, the degree to which they can be utilised is maintained and adequately managed within the economic, social and ecological goals of the water users.

The DWAF 2004 “Thukela Reserve Determination Study” was an informant to the uThukela ISP, which reported that:

“...after careful review and consideration of the Reserve Study results, it became clear that assumptions made for the Reserve Study, while valid for Reserve determination, are not valid for the allocation of water in the uThukela catchment today or in the short-term. The reasons for this are as follows:

- The Thukela Reserve water resource analysis assumed that the Reserve will ultimately be met, and in order to achieve this, curtailments were applied within the model to users throughout the catchment. This curtailment results in surplus water becoming available in the lower reaches of the Thukela River.
- The Thukela Reserve water resource analysis assumed that the Spioenkop, Ntshingwayo and Wagendrift dams will all contribute to the users and the Reserve in the Lower Thukela. This conjunctive use of these three dams results in large theoretical surpluses in the Lower Thukela.
- The methodology used in the Thukela Reserve analysis, whereby the excess yield is determined at the bottom of each key area, represents the best-case scenario. If the yield is required further upstream in the catchment, then excess yield is less. The reason for this is that releases are only made from the large dams to meet the users’ shortfalls after they have made use of run-of-river yields. The further downstream a user is situated, the more run-of-river yield becomes available, with the result that less water needs to be released from the dams and hence more surplus is available.”

(DWAF 2004: 25 – 26)

The uThukela ISP noted that a “more conservative approach was used” and that the following assumption with reference to the Reserve was used in determining the water resource availability:

“The Ecological Reserve will not be implemented immediately in the Little Thukela or Sundays River Key areas because this would require compulsory licensing. In the interim, the Reserve in the main stem of the river will need to be met from the Spioenkop and Wagendrift dams. Given that

the Little Thukela and Sundays Key Areas cannot contribute fully to the Reserve; this reduces the yield available from these two dams.”

(DWAF 2004: 26)

The Upper Thukela Region consists of the “Upper Thukela Key Area” and the “Little Thukela Key Area” as identified in the uThukela ISP. It is shown in **Table 13.4** that the Ecological Reserve for the Upper Thukela Region is 78 million m³/annum at a 1 : 50 year assurance (after DWAF 2004: 28; 32).

Table 13.4 Ecological Reserve as noted in the uThukela ISP (DWAF 2004).

| Resource Area | Water Available at a 1 : 50 Year Assurance (million m ³ /annum) |
|--|---|
| Upper Thukela Key Area as identified in the uThukela ISP (2004) | 71 ^a |
| Little Thukela Key Area as identified in the uThukela ISP (2004) | 7 ^b |
| Total | 78 |

^a DWAF 2004: 28. As determined in the Thukela Reserve Determination Study and expressed as an impact on the historical yield.

^b DWAF 2004: 32.

(b) Bushmans Region

The uThukela ISP reported that the Ecological Reserve for the Bushmans Region at a 1 : 50 year assurance was 36 million m³/annum (DWAF 2004: 35).

(c) Sundays Region

The uThukela ISP noted that the Ecological Reserve for the Sundays Region at a 1 : 50 year assurance was 5 million m³/annum (DWAF 2004: 37). As explained in **Section 13.2.2 (a)**, the ISP further stated that the Ecological Reserve will not be implemented immediately in the Sundays Region as this would require compulsory licensing (DWAF 2004: 26).

13.2.3 Existing Water Resource Infrastructure and Yields

(a) Upper uThukela Region

The significant surface water resource infrastructure in the Upper uThukela Region include both impoundments and abstractions on the uThukela River as well as abstractions on some tributaries of the uThukela River. These are listed in **Table 13.5**.

Table 13.5 Yield information for the existing water resource in the Upper uThukela Region (DWS 2019: List of Registered Dams Database, Umgeni Water 2016).

| Impoundment | River | Capacity (million m ³) | Yield (million m ³ /annum) | Stochastic Yield (million m ³ /annum) | |
|---------------|--|---------------------------------------|--|---|-------------|
| | | | Historical | 1:50 | 1:100 |
| Woodstock Dam | Thukela River | 373.26 ^a | 280.0 | Unavailable | Unavailable |
| Spioenkop Dam | Thukela River | 272.27 ^a | 73.0 | Unavailable | Unavailable |
| | Little uThukela River | - | Unavailable | Unavailable | Unavailable |
| | Klip River | - | Unavailable | Unavailable | Unavailable |
| | uThukela River (downstream of Spioenkop Dam) | - | Unavailable | Unavailable | Unavailable |

^a UAP PH2 2016: 33

^b DWS List of Registered Dams Database (April 2019)

^c Hydrology study to be undertaken, and thus determine the yield and stochastic yield of each of these impoundments

The Kilburn Dam (**Figure 13.14** and **Table 13.6**), Jagersrust Balancing Dam (**Figure 13.15** and **Table 13.7**), Woodstock Dam (**Figure 13.16** and **Table 13.8**) and Driel Barrage Dam (**Figure 13.17** and **Table 13.9**) form part of the Thukela-Vaal Scheme (**Figure 13.18**).



Figure 13.14 Kilburn Dam (DWS 2008: DWS website).

Table 13.6 Kilburn Dam (DWS 2018: Hydrographic Surveys Dams Database, DWS 2019: List of Registered Dams Database, WR2012).

| | |
|---|---|
| Catchment Details | |
| Incremental Catchment Area: | 30 km ² ^a |
| Total Catchment Area: | 30 km ² ^a |
| Mean Annual Precipitation: | 979 mm ^b |
| Mean Annual Runoff: | 10.044 million m ³ ^c |
| Annual Evaporation: | 1939 mm ^d |
| Dam Characteristics | |
| Gauge Plate Zero: | Unknown at this stage |
| Full Supply Level: | 1255.94 mASL ^e |
| Net Full Supply Capacity: | 2.1 million m ³ ^e |
| Spillway Height: | 51 m ^e |
| Dead Storage: | Unavailable |
| Total Capacity: | 36.7 million m ³ ^e |
| Original Measured Dam Capacity: | 35.966 million m ³ (1981) ^f |
| Second Measured Dam Capacity: | 35.666 million m ³ (1985) ^f |
| Third Measured Dam Capacity: | 35.577 million m ³ (1993) ^f |
| Fourth Measured Dam Capacity: | 35.559 million m ³ (2008) ^f |
| Fifth Measured Dam Capacity: | 35.552 million m ³ (2017) ^f |
| Surface Area of Dam at Full Supply Level: | 207 ha ^e |
| Dam Type: | Earth-fill ^e |
| Material Content of Dam Wall: | Unknown at this stage |
| Crest Length: | Crest Length: 1 100 m ^e Spillway section: 48 m ^g Non-spillway section: 1 052 m ^g |
| Type of Spillway: | Uncontrolled Side Channel ^e |
| Capacity of Spillway: | 570 m ³ /s ^h |
| Date of Completion: | 1981 ^e |
| Date of Last Area Capacity Survey: | 2017 ^f |
| Date of Next Area Capacity Survey: | 2027 ^f |

^a Catchment delineated using 20m DEM and Spatial Analyst.

^b WR2012 mean annual precipitation dataset (query tool in ArcGIS).

^c WR2012 mean annual runoff dataset (query tool in ArcGIS).

^d WR2012 mean annual evaporation S-Pan dataset (query tool in ArcGIS).

^e DWS List of Registered Dams Database (April 2019).

^f DWS Hydrographic Surveys Dams Database (2018).

^g Measured on Google Earth.

^h Personal communication, Mr Dieter Truter, Dam Safety Regulation, DWS (9 May 2019).



Figure 13.15 Jagersrust Balancing Dam (Google Earth 2019: website).

Table 13.7 Jagersrust Balancing Dam (DWS 2018: Hydrographic Surveys Dams Database, DWS 2019: List of Registered Dams Database, WR2012).

| | |
|---|---|
| Catchment Details | |
| Incremental Catchment Area: | 0 km ² |
| Total Catchment Area: | 0 km ² |
| Mean Annual Precipitation: | 891 mm ^b |
| Mean Annual Runoff: | 0 million m ³ ^a |
| Annual Evaporation: | 1350 mm ^d |
| Dam Characteristics | |
| Gauge Plate Zero: | Unknown at this stage |
| Full Supply Level: | 1 212.69 mASL ^e |
| Net Full Supply Capacity: | 40.475 million m ³ ^e |
| Spillway Height: | 8 m ^e |
| Dead Storage: | Unavailable |
| Total Capacity: | 0.476 million m ³ ^e |
| Original Measured Dam Capacity: | 0.476 million m ³ (1985) ^f |
| Second Measured Dam Capacity: | 0.475 million m ³ (2006) ^f |
| Surface Area of Dam at Full Supply Level: | 0.104 km ² ^e |
| Dam Type: | Earth Fill ^e |
| Material Content of Dam Wall: | Unknown at this stage |
| Crest Length: | Crest length: 400 m ^e Spillway section: 10 m ^g Non-spillway section: 390 m ^g |
| Type of Spillway: | Siphon ^e |
| Capacity of Spillway: | 20 m ³ /s ^h |
| Date of Completion: | 1973 ^e |
| Date of Last Area Capacity Survey: | 2006 ^f |
| Date of Next Area Capacity Survey: | Overdue |

^a Balancing dam with water pumped from Woodstock Dam via a canal.

^b WR2012 mean annual precipitation dataset (query tool in ArcGIS).

^c WR2012 mean annual runoff dataset (query tool in ArcGIS).

^d WR2012 mean annual evaporation S-Pan dataset (query tool in ArcGIS).

^e DWS List of Registered Dams Database (April 2019).

^f DWS Hydrographic Surveys Dams Database (2018).

^g Measured on Google Earth.

^h Personal communication, Mr Dieter Truter, Dam Safety Regulation, DWS (9 May 2019).



Figure 13.16 Woodstock Dam (DWS unknown date: DWS website).

Table 13.8 Woodstock Dam (DWS 2018: Hydrographic Surveys Dams Database, DWS 2019: List of Registered Dams Database, WR2012).

| Catchment Details | |
|---|---|
| Incremental Catchment Area: | 1 100 km ² ^a |
| Total Catchment Area: | 1 172 km ² ^a |
| Mean Annual Precipitation: | 860 mm ^b |
| Mean Annual Runoff: | 440.272 million m ³ ^c |
| Annual Evaporation: | 1922 mm ^d |
| Dam Characteristics | |
| Gauge Plate Zero: | 1135.58 mASL |
| Full Supply Level: | 1175.56 mASL ^e |
| Net Full Supply Capacity: | 373 million m ³ ^e |
| Spillway Height: | 48 m ^e |
| Dead Storage: | Unknown at this stage |
| Total Capacity: | 373 million m ³ ^e |
| Original Measured Dam Capacity: | 381.31 million m ³ (1982) ^f |
| Second Measured Dam Capacity: | 380.41 million m ³ (1986) ^f |
| Third Measured Dam Capacity: | 373.26 million m ³ (1999) ^f |
| Surface Area of Dam at Full Supply Level: | 29.16 km ² ^e |
| Dam Type: | Earth-fill ^e |
| Material Content of Dam Wall: | Unknown at this stage |
| Crest Length: | Crest length: 865 m ^e Spillway section: 17 m ^g Non-spillway section: 848 m ^g |
| Type of Spillway: | Uncontrolled Ogee |
| Capacity of Spillway: | 1 000 m ³ /s ^h |
| Date of Completion: | 1982 ^e |
| Date of Last Area Capacity Survey: | 1999 ^f |
| Date of Next Area Capacity Survey: | 2019 |

^a WR2012 quaternary catchment dataset (summation of the quaternary catchment areas contributing to the dam).

^b WR2012 mean annual precipitation dataset (query tool in ArcGIS).

^c WR2012 mean annual runoff dataset (query tool in ArcGIS).

^d WR2012 mean annual evaporation S-Pan dataset (query tool in ArcGIS).

^e DWS List of Registered Dams Database (April 2019).

^f DWS Hydrographic Surveys Dams Database (2018).

^g Measured on Google Earth.

^h Personal communication, Mr Dieter Truter, Dam Safety Regulation, DWS (9 May 2019).



Figure 13.17 Driel Barrage Dam (DWS unknown date: DWS website).

Table 13.9 Driel Barrage Dam (DWS 2018: Hydrographic Surveys Dams Database, DWS 2019: List of Registered Dams Database, WR2012).

| | |
|--|---|
| Catchment Details | |
| Incremental Catchment Area: | 517 km ² ^a |
| Total Catchment Area: | 1 689 km ² ^a |
| Mean Annual Precipitation: | 822 mm ^b |
| Mean Annual Runoff: | 701 million m ³ ^c |
| Annual Evaporation: | 1915 mm ^d |
| Dam Characteristics | |
| Gauge Plate Zero: | Unknown at this stage |
| Full Supply Level: | 1134.00 mASL ^e |
| Spillway Height: | 22.6 m ^e |
| Net Full Supply Capacity: | 10.36 million m ³ ^e |
| Dead Storage: | Unknown at this stage |
| Total Capacity: | 10.36 million m ³ ^e |
| Original Measured Dam Capacity: | 15.331 million m ³ (1973) ^f |
| Second Measured Dam Capacity: | 10.465 million m ³ (1983) ^f |
| Third Measured Dam Capacity: | 10.387 million m ³ (1986) ^f |
| Fourth Measured Dam Capacity: | 8.694 million m ³ (1996) ^f |
| Surface Area of Dam at Full Supply Level: | 2.991 km ² ^e |
| Dam Type: | Arch & Gravity ^e |
| Material Content of Dam Wall: | Unknown at this stage |
| Crest Length: | Crest length: 445 m ^e Spillway section: 45 m ^g Non-spillway section: 400 m ^g |
| Type of Spillway: | Ogee ^e |
| Capacity of Spillway: | 3 872 m ³ /s ^h |
| Date of Completion: | 1973 ^e |
| Date of Last Area Capacity Survey: | 1996 ^f |
| Date of Next Area Capacity Survey: | Overdue |

^a Catchment delineated using 20m DEM and Spatial Analyst.

^b WR2012 mean annual precipitation dataset (query tool in ArcGIS).

^c WR2012 mean annual runoff dataset (query tool in ArcGIS).

^d WR2012 mean annual evaporation S-Pan dataset (query tool in ArcGIS).

^e DWS List of Registered Dams Database (April 2019).

^f DWS Hydrographic Surveys Dams Database (2018).

^g Measured on Google Earth.

^h Personal communication, Mr Dieter Truter, Dam Safety Regulation, DWS (9 May 2019).

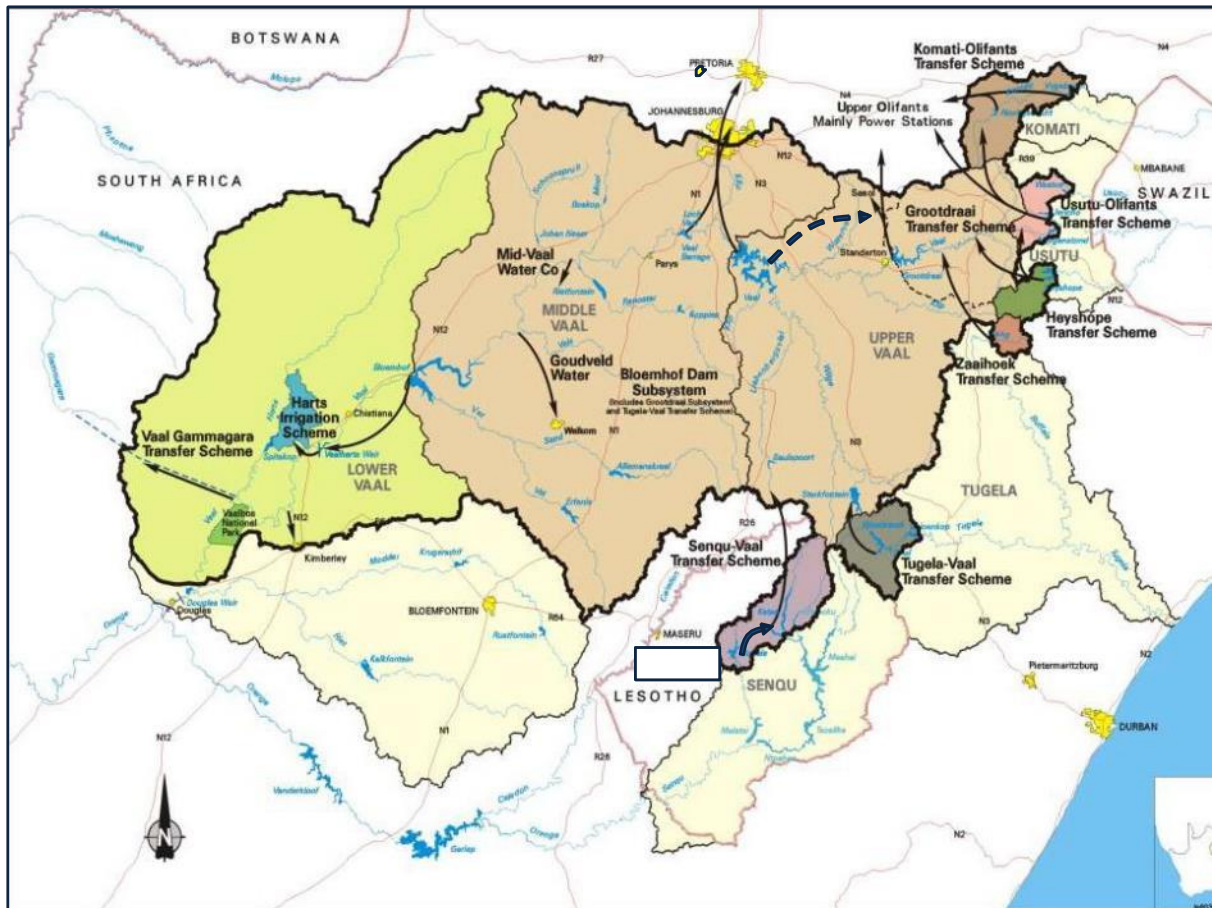

Figure 13.18 The Thukela-Vaal Transfer Scheme in the Vaal River System (DWS 2018: Slide 6).

Forming part of what is referred to as the “Vaal River Eastern Sub-System” (DWS 2018: Slide 4), the Universal Access Plan (UAP) Phase 2 Report for uThukela District Municipality (Umgeni Water 2016) and the uThukela Water Management Area (WMA) Internal Strategic Perspective (ISP) (DWA 2004) summarise the Thukela-Vaal Transfer Scheme as follows:

- “**Woodstock Dam**, located on the upper reaches of the uThukela River, is the main source of water for the scheme. The net storage capacity of the dam is 373 million m³;
- **Driel Barrage**⁵ situated on the Thukela River 7 km downstream of the Woodstock Dam. Water is released from Woodstock Dam to Driel Barrage, from where it is pumped to a transfer canal that feeds the Jagersrust Balancing Dam. The net storage capacity of Driel Barrage is 8.7 million m³;
- A **transfer canal**, which allows transferred water to gravitate to the Jagersrust Balancing Dam before it is pumped to Kilburn and over the catchment divide to Sterkfontein Dam. The canal has a maximum capacity of some 20 m³/s;
- **Diversion weirs** in the Upper Thukela River which divert run-of-river flows upstream of Woodstock Dam into the above-mentioned transfer canal. The estimated capacity of these diversions is some 4 m³/s, which is additional to the total canal capacity of 20 m³/s mentioned above;

⁵ Driel Barrage is called Driel Dam on maps. A “barrage” is a type of dam and therefore “Driel Barrage” and “Driel Dam” are used interchangeably.

- **Jagersrust Balancing Dam** (also called the **Jagersrust Pump Station Forebay**), provides balancing storage at the end of the transfer canal from where water is pumped to Kilburn Dam;
- **Kilburn Dam**, the lower reservoir in the Eskom pump storage scheme, with an active storage capacity of 27 million m³. Kilburn Dam provides both the storage for the transferred water and is a sump for the water discharged after electricity generation;
- **Sterkfontein Dam**, located in the headwaters of the Wilge River, a main tributary of the Vaal River, provides storage for water transferred over the escarpment. This dam, with a capacity of 2 617 million m³, is the fourth largest dam in South Africa. Water is released from Sterkfontein Dam to Vaal Dam when required;
- **Driekloof Dam** is the upper reservoir of the Eskom pump storage scheme and is situated in the upper reaches of the Sterkfontein Dam catchment. Water can only be transferred from Driekloof Dam to Sterkfontein Dam when Driekloof Dam is spilling;
- **Spioenkop Dam** was constructed to regulate flow downstream of the Driel Barrage to mitigate the effect of the transfer scheme. This dam has a capacity of 280 million m³. The dam also supplies water to Ladysmith and supports water requirements for the farmers between the dam and the confluence of the Little uThukela River. Releases are also occasionally called for to dilute the effluent discharged by SAPPI into the Lower uThukela River near the river mouth. It should be noted, however, that SAPPI does not have a formal allocation from the dam. The Tugela-Mhlathuze Water Transfer Scheme at Middeldrift can also be supported from Spioenkop Dam if necessary”.

(DWAf 2004: 26 – 27; Umgeni Water 2016: 34 – 35)

Spioenkop Dam (**Figure 13.19** and **Table 13.10**), located at the foot of the Spioenkop Mountain within the Spioenkop Dam Nature Reserve, supplies water to Ladysmith at a rate of 18 ML/day (6.57 million m³/annum) and provides water for irrigation (Umgeni Water 2016: 36). Ladysmith further obtains water from the Klip River although the UAP Phase 2 report noted that water supply from the Klip River is affected during drought conditions (2016: 78).

Located on the Braamhoek Spruit (Wikipedia 2019: website⁶), a tributary on the upper reaches of the Klip River (Power Technology 2019: website⁷; Wikipedia 2019: website⁸), is the Braamhoek Dam. This dam is the lower dam (Power Technology 2019: website⁹, Eskom 2013: website¹⁰) of the Ingula Pumped Storage Scheme. It is connected via 4.6 km of underground waterways (Eskom 2013: website¹¹) to the upper dam of the Ingula Pumped Storage Scheme, the Bedford Dam located on a tributary of the Wilge River (Power Technology 2019: website¹²) in the Vaal catchment. The Braamhoek Dam has a full supply level of 1 270 mASL with a roller compacted concrete dam wall and a maximum capacity of 26.26 million m³ (Eskom 2010: website¹³)

⁶ https://en.wikipedia.org/wiki/List_of_dams_in_South_Africa

⁷ <https://www.power-technology.com/projects/ingula-scheme/>

⁸ https://en.wikipedia.org/wiki/Ingula_Pumped_Storage_Scheme

⁹ <https://www.power-technology.com/projects/ingula-scheme/>

¹⁰ <http://www.eskom.co.za/Whatwerecoing/NewBuild/IngulaPumpedStorage/Documents/HY0003IngulaPumpedStorageSchemeRev8.pdf>

¹¹ <http://www.eskom.co.za/Whatwerecoing/NewBuild/IngulaPumpedStorage/Documents/HY0003IngulaPumpedStorageSchemeRev8.pdf>

¹² <https://www.power-technology.com/projects/ingula-scheme/>

¹³ <http://www.eskom.co.za/Whatwerecoing/NewBuild/IngulaPumpedStorage/Documents/Ingulatechnicalfactsheet.pdf>



Figure 13.19 Spioenkop Dam (DWS unknown date: DWS website).

Table 13.10 Spioenkop Dam (DWS 2018: Hydrographic Surveys Dams Database, DWS 2019: List of Registered Dams Database, WR2012).

| | |
|---|--|
| Catchment Details | |
| Incremental Catchment Area: | 656 km ² ^a |
| Total Catchment Area: | 2 345 km ² ^a |
| Mean Annual Precipitation: | 749 mm ^b |
| Mean Annual Runoff: | 1 247 million m ³ ^c |
| Annual Evaporation: | 1 400 mm ^d |
| Dam Characteristics | |
| Gauge Plate Zero: | 1033.36 mASL |
| Full Supply Level: | 1070.50 mASL ^e |
| Spillway Height: | 53 m ^e |
| Net Full Supply Capacity: | 279 million m ³ ^e |
| Dead Storage: | Unknown at this stage |
| Total Capacity: | 279 million m ³ ^e |
| Original Measured Dam Capacity: | 285.995 million m ³ (1972) ^f |
| Second Measured Dam Capacity: | 279.628 million m ³ (1986) ^f |
| Third Measured Dam Capacity: | 272.266 million m ³ (2001) ^f |
| Surface Area of Dam at Full Supply Level: | 15.31 km ² ^e |
| Dam Type: | Earth-fill |
| Material Content of Dam Wall: | Unavailable |
| Crest Length: | Crest length: 427 m ^e Spillway section: 155 m Non-spillway section: 272 m |
| Type of Spillway: | Side Channel |
| Capacity of Spillway: | 5 227 m ³ /s ^h |
| Date of Completion: | 1973 ^e |
| Date of Last Area Capacity Survey: | 2001 ^f |
| Date of Next Area Capacity Survey: | 2021 |

^a Catchment delineated using 20m DEM and Spatial Analyst.

^b WR2012 mean annual precipitation dataset (query tool in ArcGIS).

^c WR2012 mean annual runoff dataset (query tool in ArcGIS).

^d WR2012 mean annual evaporation S-Pan dataset (query tool in ArcGIS).

^e DWS List of Registered Dams Database (April 2019).

^f DWS Hydrographic Surveys Dams Database (2018).

^g Measured on Google Earth.

^h Personal communication, Mr Dieter Truter, Dam Safety Regulation, DWS (9 May 2019).

The Qedusizi Dam is an earth-fill flood attenuation dam with a full supply level of 1042.46 mASL located on the Klip River, upstream of Ladysmith.

A summary of the dams in the Upper uThukela Region is shown in **Table 13.11**.

Table 13.11 Existing Dams in the Upper uThukela Region (DWS 2019: List of Registered Dams Database).

| Impoundment | River | Capacity (million m ³) | Purpose |
|--------------------------|-----------------------------|------------------------------------|---|
| Woodstock Dam | Thukela River | 373 | Inter-basin transfer for domestic and industrial use in the Vaal River System |
| Driel Barrage | Thukela River | 10.36 | Holding dam from which water is pumped to the Thukela-Vaal Transfer Scheme |
| Jagersrust Balancing Dam | Not applicable ^a | 0.476 | Domestic and Industrial |
| Kilburn Dam | Mnjaneni River | 36.7 | Hydro-Power Pumped Storage |
| Spioenkop Dam | Thukela River | 280 | Domestic and Industrial |
| Shamrock Dam | Sand Spruit | 1.4 | Irrigation |
| Braamhoek Dam | Braamhoek Spruit | 25.1 | Hydro-Power Pumped Storage |
| Qedusizi Dam | Klip River | 0.051 | Flood Attenuation |
| Bell Park | Mtoti | 7.5 | Irrigation |

^a Balancing dam obtaining water via canal from Woodstock Dam.

The UAP Phase 2 reported that groundwater is also used for water supply with many consumers reliant on boreholes and springs (2016: vi). The UAP Phase 2 identified the following areas reliant on groundwater in the Upper uThukela Region:

- “The settlements of Hambrook, Green Point and Malottas Kraal in the Okhahlamba Municipality are supplied from boreholes if there is water available, but currently they are dried up (March 2016). The uThukela District Municipality manager responsible for the borehole schemes indicated that not all are in working condition and the one at Malottas Kraal provides a very low yield.
- The Blue Bank Borehole Scheme is a stand-alone scheme located in the western reaches of the Alfred Duma Municipality. The Blue Bank Borehole Scheme serves the settlements of Blue Bank and Glasgow, totalling 153 households (Census 2011).
- The Cornfields Water Supply Scheme, located west of Weenen in the Inkosi Langalibalele Municipality includes the settlements of Cornfields, Mbondwana and Thembalihle. The UAP Phase 2 reported that correspondence with the uThukela District Municipality Area Engineer indicated that Cornfields is supplied from boreholes (one is awaiting spares and is not currently operational) and water tankers, whereas Thembalihle and Mbondwana obtain water from the Mtontwanes River (Sterkspruit).
- The Driefontein Water Supply Scheme is located in central Alfred Duma Municipality, straddling both the Upper uThukela and Sundays Regions. It covers an area of approximately 850 km² and serves around 13 settlements including Watersmeed and Matiwane, totalling 12 542 households

(Census 2011). It was reported in November 2015 that consumers are supplied from groundwater and hence there is no WTP in this scheme.

- Roosboom and Meadows, in Ladysmith (Alfred Duma Municipality) are supplied at a rate of 32 kL/hr (0.384 ML/day if running a cycle of 12 hours) from the Ladysmith WTP. However, there are also boreholes in use in Roosboom, which augments supply in the case of drought as was the situation in KZN in November 2015.
- The Empangweni area in the Inkosi Langalibalele Municipality is served by a single borehole (as reported in November 2015). The UAP Phase 2 reported that this borehole is insufficient to meet the water requirements and water is also provided via water tanker (November 2015).
- The Ngedlengedleni-Umhlumayo Water Supply Scheme, in the Alfred Duma Municipality, is located between Ekuvukeni Lime Hill Water Supply Scheme and the Tugela Estates Water Supply Scheme and straddles both the Upper uThukela and Sundays regions. This scheme includes the settlements of Oqungweni, Bhaza and Ghobo. The UAP Phase 2 reported that this scheme is a borehole supply scheme (Correspondence, Ekuvukeni Lime Hill Water Supply Scheme Plant Supervisor, August 2015). It further reported that there is a small abstraction and treatment works south of this scheme (water abstracted from the sand aquifer next to the uThukela River) next to the existing Tugela Estates WTP that used to supply the Ngedlengedleni-Umhlumayo Water Supply Scheme area. This abstraction and treatment works adjacent to the Tugela Estates WTP is called the “uMhlumayo Borehole Supply System” in this IMP and is described in **Section 13.3.1 (c)**.

(Umgeni Water 2016: 41 – 52)

(b) Bushmans Region

Estcourt is supplied via two water sources: Wagendrft Dam, which supplies the George Cross WTP (Umgeni Water 2016: 45) and the Bushmans River Weir, from which water is abstracted to supply the Archie Rodel WTP (Umgeni Water 2016: 45). The UAP Phase 2 reported that the “Bushmans River is also utilised as an indirect source to supply Weenen by means of a balancing dam, supplied via an irrigation canal” (Umgeni Water 2016: 38). This report further identified that the dominant use of the Bushmans River is irrigation at 31 million m³/annum with domestic use 4 million m³/annum (Umgeni Water 2016: 38). The significant water resource infrastructure on the Bushmans River is summarised in **Table 13.12**.

Table 13.12 Yield information for existing water resource in the Bushmans Region (DWS 2019: List of Registered Dams Database).

| Impoundment | River | Capacity (million m ³) | Yield (million m ³ /annum) | Stochastic Yield (million m ³ /annum) | |
|---------------|----------------|------------------------------------|---------------------------------------|--|---------|
| | | | Historical | 1:50 | 1:100 |
| Wagendrft Dam | Bushmans River | 55.9 | 107.0 | Unknown | Unknown |

^a Hydrology study to be undertaken, and thus determine the yield and stochastic yield of each of these impoundments

Wagendrft Dam (**Figure 13.20** and **Table 13.14**), a multi-arch type dam completed in 1963 (Wikipedia 2017: website¹⁴) and named after a drift through the Bushmans River used by transport wagons en route to the Witwatersrand’s gold fields from Durban (Wildcard 2018: website¹⁵ and SA-Venues 2019:

¹⁴ https://en.wikipedia.org/wiki/Wagendrft_Dam

¹⁵ <https://www.wildcard.co.za/wagendrft-dam-nature-reserve/>

website¹⁶), is located a few kilometres upstream of Estcourt. The dam is adjacent to the N3 highway in the “Wagendrift Dam and Moor Park Nature Reserve” (EKZNW 2019: website¹⁷). The UAP Phase 2 reported that the main purpose of the dam was for irrigation and that it has a capacity of 55.9 million m³ (2016: 39). This report further states:

“The water balance in the Bushmans River catchment is 40 million m³/annum and could be utilised through this Dam. New allocations have to take cognisance however of the Fairbreeze mine development and ecological reserve requirements of the lower Tugela.”

(Umgeni Water 2016: 39)

Table 13.13 summarises the dams in the Bushmans Region.

Table 13.13 Existing Dams in the Bushmans Region (DWS 2019: List of Registered Dams Database).

| Impoundment | River | Capacity (million m ³) | Purpose |
|--------------------------|---------------------------|------------------------------------|---|
| Wagendrift Dam | Bushmans River | 55.9 | Irrigation, Domestic and Industrial Use |
| Bushmans River Weir | Bushmans River | - | Domestic Use |
| Weenen WTP Balancing Dam | Canal from Bushmans River | Unavailable | Domestic Use |

The UAP Phase 2 reported that “the area south of Shayamoya and from KwaSobabili, Good Home and Edashi onwards (south), receive water from boreholes and a weir in a tributary of the Bushmans River” (Umgeni Water 2016: 46). Referred to as the Estcourt Rudimentary Water Supply Scheme, this area is located in the south-west of the Inkosi Langalibalele Municipality.

¹⁶ <https://www.sa-venues.com/game-reserves/wagendrift.php>

¹⁷ <http://www.kznwildlife.com/Wagendrift.html>



Figure 13.20 Wagendrift Dam (Michael Cookson, Unknown Date:<http://www.panoramio.com>).

Table 13.14 Wagendrift Dam (DWS 2018: Hydrographic Surveys Dams Database, DWS 2019: List of Registered Dams Database, WR2012).

| | |
|---|--|
| Catchment Details | |
| Incremental Catchment Area: | 743 km ² ^a |
| Total Catchment Area: | 743 km ² ^a |
| Mean Annual Precipitation: | 803 mm ^b |
| Mean Annual Runoff: | 221 million m ³ ^c |
| Annual Evaporation: | 1 350 mm ^d |
| Dam Characteristics | |
| Gauge Plate Zero: | 1151.1 mASL |
| Full Supply Level: | 1181.56 mASL ^e |
| Spillway Height: | 41.15 m ^e |
| Net Full Supply Capacity: | 52.12 million m ³ ⁱ |
| Dead Storage: | 3.78 million m ³ (1999) ^g |
| Total Capacity: | 55.9 million m ³ ^e |
| Surface Area of Dam at Full Supply Level: | 5.084 km ² ^e |
| Original Measured Dam Capacity: | 60.008 million m ³ (1963) ^f |
| Second Measured Dam Capacity: | 58.806 million m ³ (1972) ^f |
| Third Measured Dam Capacity: | 58.455 million m ³ (1983) ^f |
| Fourth Measured Dam Capacity: | 55.900 million m ³ (1999) ^f |
| Dam Type: | Multi-arch ^e |
| Material Content of Dam Wall: | Concrete |
| Crest Length: | Crest length: 281 m ^e Spillway section: 136 m Non-spillway section: 145 m |
| Type of Spillway: | Ogee Spillway ^e |
| Capacity of Spillway: | 2 420 m ³ /s ^h |
| Date of Completion: | 1963 ^e |
| Date of Area Capacity Survey: | 1999 ^f |
| Date of Next Area Capacity Survey: | 2019 |

^a WR2012 quaternary catchment dataset (summation of the quaternary catchment areas contributing to the dam).

^b WR2012 mean annual precipitation dataset (query tool in ArcGIS).

^c WR2012 mean annual runoff dataset (query tool in ArcGIS).

^d WR2012 mean annual evaporation S-Pan dataset (query tool in ArcGIS).

^e DWS List of Registered Dams Database (April 2019).

^f DWS Hydrographic Surveys Dams Database (2018).

^g Measured on Google Earth.

^h Personal communication, Mr Dieter Truter, Dam Safety Regulation, DWS (9 May 2019).

ⁱ Total capacity – dead storage.

(c) Sundays Region

The UAP Phase 2 report (2016: 39) and the “Ekuvukeni Water Supply Scheme: Olifantskop Dam Decision Support System” report (DWA 2012: 4 – 5) indicate that there are two significant dams in this region. These include the:

- Olifantskop Dam (**Table 13.15** and **Figure 13.21**) which supplies the Olifantskop WTP, the source of water for the Ekuvukeni and Lime Hill areas and
- Slangdraai Dam, an irrigation dam situated upstream of the Olifantskop Dam.

The Olifantskop Dam was built in 1985 as part of the Ekuvukeni Water Supply Scheme, to supply raw water to the Olifantskop WTP (DWA 2012: 4). It is owned and operated by the uThukela WSA (DWA 2012: 4). The DWS study reported that the origin and all technical documentation of Olifantskop Dam is unknown (2012: 4). The original storage capacity was estimated (using topographical maps predating its construction) at 1.5 million m³ in the “Indaka Bulk Water Supply: Feasibility Study” (uThukela District Municipality 2006). A survey conducted as part of the 2006 “Indaka Bulk Water Supply” study indicated that the “live storage” of the dam is 0.43 million m³ (DWA 2012: 4). The subsequent “Indaka Water Audit” study (uThukela District Municipality 2007) stated that the storage was 0.3 million m³ (DWA2012: 4). The DWA study reported:

“The main cause of rapid siltation of the dam is due to very small storage capacity relative to the upstream catchment size and runoff (original storage capacity of 1.5 million m³ versus the natural MAR of about 90 million m³/annum). Possible over-grazing in some portions of the upstream catchment may also further exacerbate the sedimentation problem.”

(DWA 2012: 4)

The Slangdraai Dam is situated upstream of the Olifantskop Dam and was built in 1986 for irrigation purposes (DWA 2012: 5). Owned by the Sundays River Irrigation Board, it has a capacity of 10.3 million m³ with a surface area of 240 ha and an estimated historical gross yield of approximately 6.14 million m³ as determined by the 2011 DWA Study entitled “The Development of a Reconciliation Strategy for All Towns in the Eastern Region. uThukela District Municipality: First State Reconciliation Strategy for Ekuvukeni WSS – Indaka Local Municipality” (DWA 2012: 5).

During dry seasons the Olifantskop Dam relies on releases from the Slangdraai Dam and the Mielie Tuin Hoek Dam. Releases from the Slangdraai Dam are fairly regular and in line with the minimum required releases. There are no formal operating rules for the Slangdraai Dam, but DWS KZN regional office¹⁸ have confirmed that the farmers that manage the Slangdraai Dam are compliant. The Sundays River Irrigation Board was granted a Section 9B(1) Permit, reference B191/2/2060/1 on 11 April 1986 for the storage of 10.3 million cubic meters and the abstraction of 15.4 million cubic meters per year for irrigation within the board area. They were also required to release all normal flows below and up to a maximum of 230 ℓ/s unhindered through the dam and over the downstream boundary of the board. In the latter half of 2019, Umgeni Water (UW) installed flow monitoring in the Sundays River Catchment, downstream of the confluence of Dwaars Rivier and Nkunzi River, and just upstream and just downstream of the Slangdraai Dam, whilst increasing communication with the farmers/irrigation board. This has resulted in an increased assurance of supply at Olifantskop Dam, which has been kept

¹⁸ Personal communication, Mrs Angela Masefield, Director, DWS, KZN regional office (30 March 2020)

full from mid-November 2019 to end March 2020¹⁹. Umgeni Water recently undertook a hydrographic survey of the Olifantskop Dam and it proved a **current** dam capacity of 0.379 million m³. This is a little more than a third of the original capacity of the dam and proves the impact that siltation has had on this resource. The reduced storage capacity requires continued close monitoring of the resource so as to ensure that adequate storage is maintained for Ekuvukeni and surrounds.

The dams occurring in the Sundays Region are summarised in **Table 13.16** and the yield information is presented in **Table 13.17**.

¹⁹ Umgeni Water, Water Resource Management Decision Support System (WRMDSS) (31 March 2020) http://uwpmb0210/wrmdss/DashboardEngine.aspx?DashboardID=Umgeni%5c%5cReports%5c%5cFixed_Reports%5c%5cReport_Level_Rainfall



Figure 13.21 Olifantskop Dam (uThukela District Municipality 2018).

Table 13.15 Olifantskop Dam (DWA 2012: 17; WR2012).

| | |
|---|---|
| Catchment Details | |
| Incremental Catchment Area: | 912.5 km ² ^a |
| Total Catchment Area: | 1 019 km ² ^a |
| Mean Annual Precipitation: | 783 mm ^b |
| Mean Annual Runoff: | 90.3 million m ³ ^c |
| Annual Evaporation: | 1500 mm ^d |
| Dam Characteristics | |
| Gauge Plate Zero: | 881.34 m |
| Full Supply Level: | 885.98 m ^e |
| Spillway Height: | 4.64 m |
| Net Full Supply Capacity: | 0.379 million m ³ |
| Dead Storage: | 0 million m ³ |
| Total Capacity: | 0.379 million m ³ (Current Capacity) ^c |
| Surface Area of Dam at Full Supply Level: | 0.233 km ² ^c |
| Original Measured Dam Capacity: | 1.45 million m ³ (Original Estimated Capacity) ^c |
| Measured Dam Capacity: | 0.379 million m ³ |
| Dam Type: | Concrete |
| Material Content of Dam Wall: | Concrete |
| Crest Length: | Crest length: 273 m ^g Spillway section: 90 m ^g Non-spillway section: 183 m ^g |
| Type of Spillway: | Ogee Spillway |
| Capacity of Spillway: | Unknown at this stage |
| Date of Completion: | 1985 ^c |
| Date of Area Capacity Survey: | 2019 |
| Date of Next Area Capacity Survey: | 2029 |

^a WR2012 quaternary catchment dataset (summation of the quaternary catchment areas contributing to the dam).

^b WR2012 mean annual precipitation dataset (query tool in ArcGIS).

^c DWA 2012: 17.

^d WR2012 mean annual evaporation S-Pan dataset (query tool in ArcGIS).

^e uThukela District Municipality 2006 in DWA 2012: 17.

^f Calculation based on DWA 2012: 17 (15% of 1.45 million m³).

^g Measured on Google Earth.

Table 13.16 Existing Dams in the Sundays Region (DWA 2012: 17).

| Impoundment | River | Capacity (million m ³) | Purpose |
|-----------------|---------|--|-----------------------|
| Slangdraai Dam | Sundays | 10.3 ^a | Irrigation & domestic |
| Olifantskop Dam | Sundays | 1.45 (Original Estimated Capacity) ^a 0.2175 (Assumption of 85% Siltation) ^b | Domestic |

^a DWA 2012: 17

^b Calculation based on DWA 2012: 17 (15% of 1.45 million m³)

Table 13.17 Yield information for the existing water resource abstractions in the Sundays Region (DWA 2012: 17; 20; 24).

| Impoundment | River | Capacity (million m ³) | Yield (million m ³ /annum) | Stochastic Yield (million m ³ /annum) | |
|-----------------|---------|--|--|--|---------------------------------------|
| | | | Historical | 1:50 | 1:100 |
| Slangdraai Dam | Sundays | 10.3 ^a | 4.17 ^c | Unknown | Unknown |
| Olifantskop Dam | Sundays | 1.45 (Original Estimated Capacity) ^b 0.2175 (Assumption of 85% Siltation) ^b | 3.34 ^c 1.10 ^c | 3.72 ^d 1.39 ^d | 3.5 ^d 1.30 ^d |

^a DWA 2012: 17

^b Calculation based on DWA 2012: 17 (15% of 1.45 million m³)

^c DWA 2012: 20

^d DWA 2012: 24

The 2012 DWA Study indicated that “five boreholes are also able to supply water into the Ekuvukeni system, but are only used as emergency measures when the Olifantskop Dam runs empty, due to water quality problems of the groundwater” (2012: 3 – 4). The study reported that “sulphate is a problem and the water quality of the boreholes is further impacted by a growing graveyard located close to two of the boreholes” (DWA 2012: 12). uThukela DM staff²⁰ have confirmed the status of these 5 production boreholes, and noted that water quality is still poor (high sulphate). They are located in the following areas:

- Limehill: Discharges into Limehill reservoir. Normally only used in Winter. In current use due to low output of the Olifantskop WTP.
- Rockcliff: Not functional at present (and in last few months), as the water table at that point has dropped. It fed the Ekuvukeni reservoir.
- KwaJwili: It feeds the Ekuvukeni reservoir. In current daily use.
- Qhinkhowe: It feeds the Ekuvukeni reservoir. In current daily use. Located close to the Ubusi River. The pump is powered by a diesel engine, and the yield is particularly good.
- Ekuvukeni (central): Use of this borehole has been completely discontinued, due to the poor water quality (it is downstream of a large cemetery).

These boreholes are operated solely by uThukela DM.

In April 2019, UW drilled five boreholes in the Ekuvukeni area, upon request from uThukela DM (the client). Test pumping revealed that four of these five boreholes had a usable yield. The total sustainable yield of the four boreholes was rated at 1.5 Mℓ/day, but the water quality was poor (high

²⁰ Personal communication, Mr Lethu Mchunu, Superintendent, uThukela DM, Ekuvukeni (30 March 2020)

fluoride and sulphur). Options considered for treatment were defluoridation (activated alumina adsorption), ultrafiltration and reverse osmosis but were found to be prohibitively expensive, and these four boreholes were never equipped²¹. The risks associated with the option of blending the borehole water with treated water from the Olifantskop WTP were significant (due to operational challenges in the water scheme) and these boreholes were eventually capped.

As stated in **Section 13.2.3 (a)**, the Ngedlengdleni-Umhlumayo Water Supply Scheme, located south of the Ekuvukeni Water Supply Scheme, also uses boreholes.

13.2.4 Operating Rules

(a) Upper uThukela Region

As indicated in **Section 13.2.3**, the UAP Phase 2 (2016) and the uThukela ISP (2004) reported that the purpose of Spioenkop Dam is to regulate flow downstream of the Driel Barrage to mitigate the effect of the Thukela-Vaal Transfer Scheme. The Thukela-Vaal Transfer Scheme forms part of what is called the “Bloemhof Sub-System” in the Integrated Vaal River System (DWAf 2006: C1-1). DWS explains the operation of the Thukela-Vaal Transfer Scheme as follows:

“... water is released from Woodstock Dam to Driel Barrage from where it is pumped and conveyed to the lower level of the Drakensberg Pump Storage Scheme (**Figure 13.22**). From here it is further pumped into Sterkfontein Dam located at the higher elevation on the escarpment. The normal operating rule, with the objective of maximising yield in the system, is to continue the transfer until Vaal and Bloemhof Dams (**Figure 13.18**) are full. However, during wet hydrological conditions when the dam levels are relatively high or in the case where excess supply capability in the system is present, the transfer volume is reduced to save pumping costs. These deviations are only implemented if it is proven, through scenario analysis, that the long term assurance of supply will not be jeopardised.”

(DWAf 2006: C2-2)

“The capacity of the Woodstock and Driel Barrage pumping infrastructure capacity is about 20 m³/s but can peak to 35 m³/s at times. The Driel Barrage Dam downstream releases of 0.8 m³/s were increased to 1 m³/s for operational convenience as per the operating rule. The releases are both for irrigation and environmental requirement purposes. The Driel Barrage Dam can release up to 120 m³/s using the scour and 1000 m³/s using the three radial gates. These releases are automated based on the Driel Barrage Dam storage level. The level is kept at 100% and any excess water is automatically discharged. If the level is below 100% full, more water is released from Woodstock Dam. Woodstock Dam can release up to 400 m³/s using the two sluice gates. Both Woodstock and Driel Barrage dams do not have multiple abstraction/release levels. Releases from Driel Barrage Dam trigger the flood warning procedures for Spioenkop Dam. Driel Barrage Dam is kept at 100% whilst Woodstock hardly spills due to the high water transfer demand.”

²¹ Personal communication, Mr Nathaniel Padayachee, Planning Engineer, UW, Head Office, Pietermaritzburg. (31 March 2020)

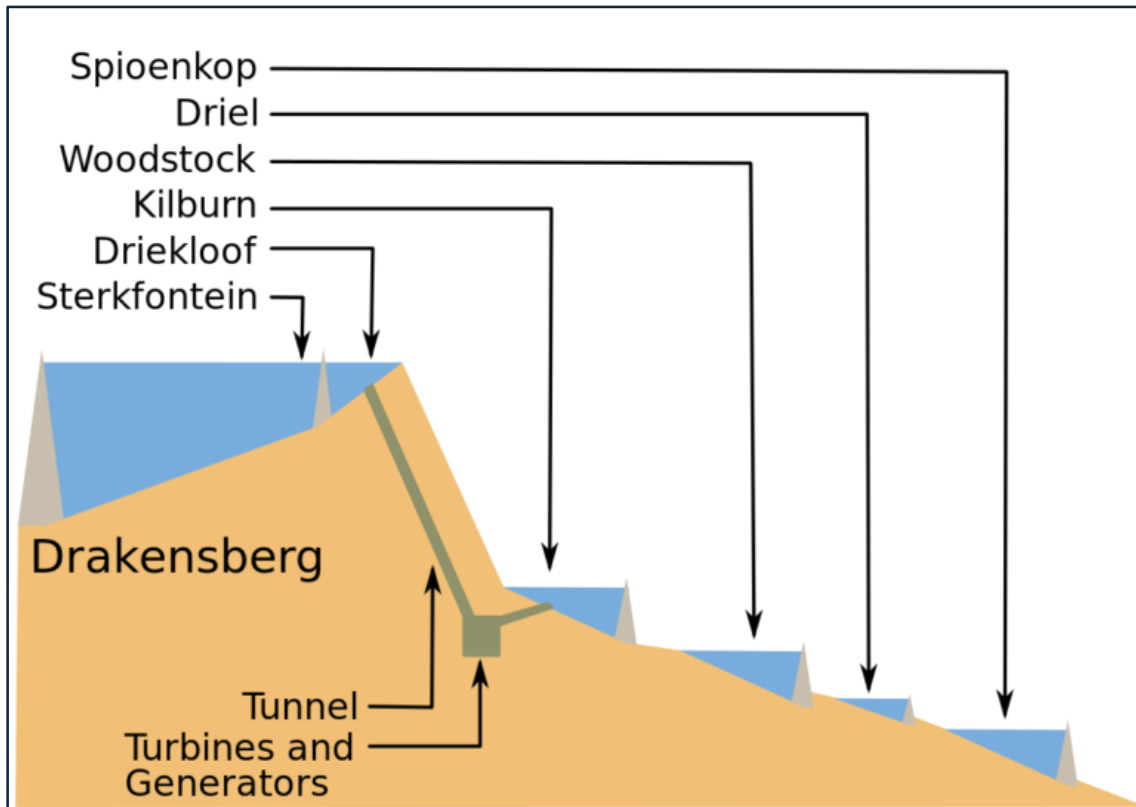

Figure 13.22 Longitudinal profile of the Thukela-Vaal Scheme and the Drakensberg Pumped Storage Scheme (Ladysmith Gazette 2017: website²²).

The Vaal River System operating rules are reviewed annually. The DWS Vaal River System Annual Operating Analysis 2018/19 indicated that no transfers occur once Sterkfontein Dam is full (2018: Slide 12). It reported that the installed capacity for pumping from Driel Dam is 18.8 m³/s and from Woodstock to Kilburn is 20 m³/s with current pumping occurring at 14.6 m³/s from Driel and 16.7 m³/s from Woodstock to Kilburn (2018: Slide 52). It was further noted that “maximum pumping from uThukela needs to be addressed, especially in light of the upcoming years where efficient management will be critical” (2018: Slide 52). The scenarios informing the operating rule recommendations for the Thukela-Vaal Transfer Scheme are shown in **Table 13.18**. The recommendation for the Thukela-Vaal Transfer Scheme was that for 2018/2019, pumping would continue until the Sterkfontein Dam is full and that thereafter the standard rule would apply until the Bloemhof Dam is full (DWS 2018: 68).

Table 13.18 Vaal River System annual operating analysis 2018/2019 scenarios for the Thukela-Vaal Transfer (DWS 2018: Slide 59).

| Infrastructure and Operating Rules Thukela-Vaal Transfer (Sterkfontein Support to Vaal: Seasonal) | | |
|---|--|--|
| Scenario | 2018 | 2019 Onwards |
| A - Realistic | Driel: 14.6 m ³ /s Total: 16.7 m ³ /s | Driel: 18.8 m ³ /s Total: 20.0 m ³ /s |

²² <https://ladysmithgazette.co.za/81846/current-level-ladysmiths-spioenkop-dam-dam-levels-kzn/>

| | Pump: Sterkfontein Full | Pump: Bloemhof Full |
|--|---|---|
| A₂ - Normal | Driel: 14.6 m ³ /s Total: 16.7 m ³ /s Pump: Sterkfontein Full | Driel: 18.8 m ³ /s Total: 20.0 m ³ /s Pump: Bloemhof Full |
| A₃ – Vaal River Eastern Sub-System Augmentation Project (VRESAP) | Driel: 14.6 m ³ /s Total: 16.7 m ³ /s Pump: Sterkfontein Full | Driel: 18.8 m ³ /s Total: 20.0 m ³ /s Pump: Bloemhof Full |
| B - Worst | Driel: 14.6 m ³ /s Total: 16.7 m ³ /s Pump: Sterkfontein Full | Driel: 14.6 m ³ /s Total: 16.7 m ³ /s Pump: Bloemhof Full |
| C – Rand Water (RW) | Driel: 14.6 m ³ /s Total: 16.7 m ³ /s Pump: Sterkfontein Full | Driel: 18.8 m ³ /s Total: 20.0 m ³ /s Pump: Bloemhof Full |

The Thukela ISP identified the dependency of the Vaal River System on the Thukela-Vaal Transfer Scheme, stating the following:

There is a “need to reserve the current transfer volumes. New allocations that are dependent on the same water resource as the transfer i.e. Woodstock Dam and Driel Barrage should therefore only be allocated to supply Basic Human Needs... In general, new allocations and the construction of farm dams should be discouraged upstream of Driel Barrage.”

(DWAf 2004: 29)

In 2001, DWAf summarised the Spioenkop operating rules as follows:

“An amount of 2 m³/s is released from the dam to meet the downstream irrigation and environmental requirements if the dam is not spilling. However, an amount of around 1 m³/s was released from the dam prior to 1996. The irrigation requirements immediately below the dam to Weenen amount to 2.40 million m³/annum (1995) and 4.70 million m³/annum (1995) at Mandini. These are projected to 3.01 and 11.03 million m³/annum by 2030, respectively. However, requests from downstream users (farmers, SAPPI, Middledrift transfer scheme operators and canoe clubs) sometimes push this figure up to 24 m³/s. Releases of 5 m³/s are sometimes made on requests from SAPPI to dilute their high concentrated return flows near Mandini. In the event of the Middledrift Transfer Scheme (1.2 m³/s transfer capacity) being operational, water can also be released from Spioenkop to ensure sufficient water downstream of Middledrift.

The dam has two abstraction levels. Ladysmith gets water, 1.38 million m³/annum (1995) directly from the dam. It is estimated that 6.25 million m³/annum will be drawn from Spioenkop for Ladysmith.

Farmers downstream of the dam are warned if releases of 26 m³/s or more are to be made. Making releases from Spioenkop Dam to meet the Thukela water requirements is preferred to using Wagendrift Dam due to the dam size and cost effectiveness realised. However, the Department of Water Affairs and Forestry are exploring the possibility of using Wagendrift to meet these water requirements.

According to the Spioenkop Dam operating rule, the dam is supposed to be kept at 85% full if possible to take advantage of its flood attenuation capacity. However, this has been difficult to achieve due to the high runoff and underutilisation of the dam (in 2001). The dam only spills during wet summer months for a short period of time.”

(DWAf 2001: 3 – 4)

The literature review did not identify documented operating rules for the other abstractions in the Upper uThukela Region (**Table 13.5**). More recent documentation, such as the UAP Phase 2 (2016: 35) and the DWS Reconciliation Strategies for the Colenso Water Supply Scheme (DWA 2011(a): 33), Ezakheni Water Supply Scheme (DWA 2011(b): 43) and the Ladysmith Water Supply Scheme (DWA 2011(c): 29), only note that “the current operating rules of the Upper uThukela River System are such that water is released from the Spioenkop Dam to support downstream demands such as SAPPI at Mandeni for dilution purposes... and to meet the estuarine Reserve requirements”. Critically, the UAP Phase 2 (2016: 36), the Thukela ISP (2004: 50) and all the Reconciliation Strategies for the Water Supply Schemes in the uThukela District Municipality (2011(a) – (g)) identify the *need for the development and refinement of operating rules for Spioenkop Dam and the abstractions on the uThukela river* in order to meet the growing demands in the area.

(b) Bushmans Region

DWS currently operate the Wagendrift Dam and the Bushmans Supply System. The yield of the dam far exceeds the existing demand and as a result there are no specific operating rules for this water resource. DWS have confirmed that they will be developing operating rules for this system in the near future.

(c) Sundays Region

The operating rule for the water supply from the Olifantskop Dam, as documented in 2012, was as follows:

- i. “The uThukela District Municipality utilises water from Olifantskop Dam up to the capacity of the infrastructure until the dam runs dry (abstraction and distribution works at Olifantskop WTP).
- ii. If Olifantskop Dam runs dry, as was the case during the droughts of 2003/2004 and 2006/2007, the uThukela District Municipality revert back to groundwater, i.e. five emergency boreholes in the area. However, the sulphate content of these boreholes is very high and as a result the boreholes are not the preferred source of supply for the users within the Olifantskop Dam/Ekuvukeni Water Supply Scheme. The volume of water supply from the boreholes is very low and as such water has had to be brought in by a tanker during those drought periods.
- iii. Infrastructure capacity constraints exist at both the water treatment plant as well as the abstraction pumps, the result being that there is insufficient treated water to keep the system charged.
- iv. The capacity of the Olifantskop WTP is limited due to silt loads of raw water and the ability to only run one abstraction pump.
- v. uThukela District Municipality has to operate the bulk reservoirs on an eight hours on-off schedule.
- vi. The electricity supply within the Water Supply Scheme is regularly interrupted due to storms. Electrical power outage or burst pipes result in longer downtimes.
- vii. The result of the above is that users are permanently being indirectly curtailed due to infrastructure capacity constraints.”

(DWA 2012: 22 – 23)

Note that the capacity of the Olifantskop WTP is still limited due to silt loads of raw water and the refurbishment/upgrade of the WTP that has been ongoing since March 2019 e.g. one bank of filters are currently offline as they are being refurbished, and the plant can only produce 3.5 Mℓ/day at present (March 2020). Two raw water pumps can be used simultaneously, but the WTP is then unable to produce acceptable water quality due to the silt load, and the inherent design limitations of the WTP. Hence, the use of one raw water pump by the operators.

uThukela District Municipality is still implementing water shedding at Ekuvukeni. There is rotation for all the areas fed by the Olifantskop WTP (weekly schedule).²³

The findings of the 2012 DWS study to develop operating rules of the Olifantskop Dam included:

- “Even at a low recurrence interval of 1 : 20 years the yield of the Olifantskop Dam is not sufficient to supply the users within the Ekuvukeni Water Supply System and therefore the resource also places a constraint on the supply of water.
- The current (2012) volume of water supplied from the Olifantskop WTP is in the order of 6.67 ML/day (2.43 million m³/annum), and is currently supplied at a very low recurrence interval of 1 : 1 or a failure every year. This is much less than even the lower end of domestic water supply criteria of 95% assurance of supply (failure 1 : 20 years) and poses a very high risk which confirms the regular shortages currently experienced.
- The objective of a drought restriction operating rule is to restrict water use during periods with low reservoir storage and, in doing so, prevent a total failure of supply. However, in the case of the Ekuvukeni Water Supply Scheme and the Olifantskop Dam, the users are already being severely curtailed due to the infrastructure capacity constraints of the system. The system is thus permanently operated in a restricted state, which is then worsened by periodic complete failures of the system due to over-allocation of the water resource and the limited storage of water due to silt levels in the dam... As such, there are a number of other measures that need to be put in place first, such as the removal of capacity constraints and the reduction in losses in the system, before the adoption of drought operating rules can result in an improvement in water supply assurance to the users.”

(DWA 2012: 24 – 25)

The recommendations of this study included:

- “No additional water users or water requirements should be placed on the Water Supply System as the water resources are already severely over-allocated.
- The uThukela District Municipality should immediately proceed with the implementation of WC/WDM to reduce the level of over-allocation of the resource and improve operation and non-supply times from the bulk reservoirs of the system.
- The legality of users upstream of Olifantskop Dam should be checked.
- The hydrology for the Sundays Region needs to be updated and refined.
- Once an alternative source of water is introduced to the system, the DWA should re-look at the optimisation of the system and the development of water supply and operating rules for the Olifantskop Dam/Ekuvukeni Water Supply Scheme.”

(DWA 2012: 28 – 29)

13.3 Supply Systems

13.3.1 Description of the Upper uThukela System

(a) Overview

As stated in **Section 13.1**, as of 1 July 2018 Umgeni Water operates:

- The Ezakheni WTP, which is located approximately 15 km south of Ladysmith (as the crow flies) on the banks of the uThukela River and supplies the areas of Ezakheni A to Ezakheni E,

²³ Personal communication, Yovesh Danilala, Operations, UW, North West Region (20 March 2020)

Acaciavale, Umbulwana, Graythorne and Brakfontein in the Alfred Duma Municipality. This WTP is discussed in **Section 13.3.1 (b)**.

- The Tugela Estates WTP (**Section 13.3.1 (c)**), which is located in the south-eastern portion of the Alfred Duma Municipality, approximately 1 km from the uThukela River (and approximately 44 km south-east of Ladysmith (as the crow flies) and supplies the areas of Kokwane, Langa, Mbango, The Ravine, Tugela Estates and Zamazema.
- The Olifantskop WTP (**Section 13.3.1 (d)**), which is located approximately 29 km north-east of Ladysmith (as the crow flies) in the Alfred Duma Municipality on the banks of the Sundays River and supplies the areas of Ekuvukeni, Amakazi, Entabeni, Limehill, Mziyanke, Zamokuhle, Mjinti and Ndaka.

As shown in **Figure 13.3** and **Figure 13.4**, the Ezakheni WTP and the Tugela Estates WTP form part of the Spioenkop Sub-System. The Olifantskop WTP forms part of the Sundays Sub-System (**Figure 13.3** and **Figure 13.4**).

uThukela District Municipality currently operates the remaining WTPs within its area viz.:

- The Moyeni WTP supplies the Zwelisha Moyeni Water Supply Scheme which is located in western Okhahlamba Municipality and supplies the areas of Mkukwini, Nyusana, Zwelisha, Amazizi, Bhalekisi, Mazazini (including Newstende) and Moyeni (Umgeni Water 2016: 51). The UAP Phase 2 reported that water is abstracted from a canal and weir system in the Khombe River (**Table 13.5**), a tributary of the uThukela River and is treated at the 5 Mℓ/day WTP (2016: 51).
- The Langkloof WTP is “located in the northern part of Okhahlamba Municipality, north-west of the Woodstock Dam and supplies the Langkloof settlement, which is approximately 3 km south of the Kilburn Dam wall” (Umgeni Water 2016: 48). Water is abstracted from the uThukela River (**Table 13.5**) and pumped to this 0.1 Mℓ/day package plant (Umgeni Water 2016: 48).
- The Bergville WTP, is “located in the central area of Okhahlamba Municipality, north of the Driel Barrage and between the Woodstock Dam in the west and Spioenkop Dam in the east and supplies the areas of Bergville, Bethany, iNdanyana, Rookdale, Woodford, Hambrook, Action Homes, Malottas Kraal and Green Point” (Umgeni Water 2016: 41). The UAP Phase 2 reported that this is a 4 Mℓ/day WTP which abstracts water from the Driel Barrage (**Table 13.5** and **Table 13.9**) (2016: 41).
- The Loskop WTP is located on the northern boundary of the Inkosi Langalibalele Municipality, approximately 29.45 km north-west of Estcourt as the crow flies and supplies the settlements of Bhekuzulu, Engonyameni and Etatane (Umgeni Water 2016: 48). The UAP Phase 2 reported that water is abstracted from the Little uThukela River (**Table 13.5**) and treated at the 1.2 Mℓ/day WTP (2016: 49).
- The Winterton WTP is “located in the eastern section of Okhahlamba Municipality and supplies the areas of Winterton and Khethani” (Umgeni Water 2016: 51). The UAP Phase 2 reported that water is abstracted from a weir in the Little uThukela River (**Table 13.5**) and is treated at the 1.3 Mℓ/day WTP (2016: 51).
- The Colenso WTP, is “located in the southern portion of the Alfred Duma Municipality and serves Colenso, Inkanyesi and Magazini” (Umgeni Water 2016: 42). The UAP Phase 2 reported

that the Colenso WTP abstracts water from the uThukela River (**Table 13.5**) and that the design capacity needs to be confirmed. The 2014 Blue Drop Report (DWS), and the previous process controller, identified the design capacity as 2.6 ML/day and 2.0 ML/day respectively (2016: 42).

- The Ladysmith WTP is located on the banks of the Klip River, approximately 3 km north-west of Ladysmith as the crow flies in the Alfred Duma Municipality and supplies the areas of Ladysmith, Steadville, Ezakheni, Roosboom and Meadows (the latter two areas are located approximately 8 km to the south-west of Ladysmith) (Umgeni Water 2016: 47). The UAP Phase 2 reported that the 23 ML/day WTP obtains water from the Klip River (10 ML/day) and the Spioenkop Dam (19 ML/day)²⁴ (**Table 13.5** and **Table 13.10**) (2016: 47).
- The Archie Rodel WTP is located south-west of Estcourt in the Inkosi Langalibalele Municipality and is one of two WTPs providing treated water to the Estcourt Water Supply Scheme which supplies Estcourt, Wembezi, Zwelisha and Boschi (Umgeni Water 2016: 45). The UAP Phase 2 reported that the Archie Rodel WTP abstracts water from the Bushmans River Weir (**Table 13.12**) and that the 2014 Blue Drop listed the design capacity as 12 ML/day but that uThukela District Municipality identified the design capacity as 14 ML/day (2016: 45).
- The George Cross WTP is the second WTP supplying the Estcourt Water Supply Scheme. The UAP Phase 2 reported that water is abstracted at the Wagendrift Dam (**Table 13.12** and **Table 13.14**) and is pumped to the WTP which has a design capacity of either 21 ML/day (2014 Blue Drop Report) or 18 ML/day (uThukela District Municipality) (2016: 45).
- The Weenen WTP is located in the eastern part of the Inkosi Langalibalele Municipality and serves the areas of Weenen, Ezitendeni and Impembeni (Umgeni Water 2016: 50). The UAP Phase 2 reported that water is abstracted from a balancing dam that is supplied from an irrigation canal obtaining water from the Bushmans River (**Table 13.12**) and that the 1.45 ML/day (uThukela District Municipality) or 1.4 ML/day WTP is located south of Weenen, on the banks of the Bushmans River (2016: 50). An additional WTP was commissioned in November 2017 at Weenen (same water source) and has a design capacity of 2.5 ML/day²⁵. It is located 2km from the old WTP.

As shown in **Figure 13.3** and **Figure 13.4**, the Tugela Ferry WTP and the Pomeroy WTP form part of the Sundays Sub-System. These WTPs fall under uMzinyathi DM and are operated by the WSA.

- The Tugela Ferry WTP is located in the southern part of Msinga and serves Tugela Ferry and Sampofu. The peak hydraulic design capacity of the water treatment works is only 3.1 ML/day or 1.825 million m³/a (WSDP, 2008). The average annual flow rate of the treatment works is estimated to be 4.0 ML/day or 1.5 million m³/a based on a peak factor of 1.5 (Umgeni Water 2016b: 30). The WTP draws raw water from the uThukela River. A new WTP has recently been built (yet to be commissioned) in the same area and has a design capacity of 8ML/day. Pomeroy WTP is a small package plant that will now be decommissioned. Associated bulk infrastructure (pipelines, reservoirs and pump stations) were also constructed, and form part of what is referred to as the Msinga Bulk Water Supply Scheme.

²⁴ Personal communication, Mr Abre Nel, Area Manager, uThukela DM staff, Emnambithi LM (12 August 2019)

²⁵ Personal communication, Mr Navin Naicker, Weenen Plants Manager, uThukela DM staff, Inkosi Langalibalele LM (May 2020)

(b) Ezakheni Water Treatment Plant and Supply System

The Ezakheni WTP (**Figure 13.23, Table 13.19**) abstracts water from the uThukela River Weir (**Table 13.5**), the yield of which is currently unknown. The WTP has a design capacity of 32 ML/day (Umgeni Water 2016: 46)²⁶ with UAP Phase 2 reporting that the WTP was operating between 47 ML/day and 51 ML/day (160% of design capacity) in August 2015 (2016: 46). An Umgeni Water 2017 Process Audit reported that on the day of assessment (June 2017), the inflow rate was 49 ML/day (Umgeni Water 2017: 11). Metered readings from the plant over a four-month period (January to November 2019) indicate that the plant was producing up to 38 ML/day. In an effort to improve the water quality at the plant, the production at the plant has been decreased to an average of 30 ML/day since late 2019 to present (March 2020). Another reason for the reduction in production is the maintenance and repairs that are being carried out within the plant.

Combined raw water abstraction is in the order of 42 ML/day. The operators are running two APE turbine pumps and one Flygt submersible. The water losses within the plant treatment process is in the order of twenty percent, as there is currently no means with which to recycle backwash water or waste water (from desludging clarifiers and pre-settling tanks). A further reason for high water losses within the plant is that the backwashing of the filters is not particularly efficient, due to the design and the lack of automation. UW is addressing this issue.

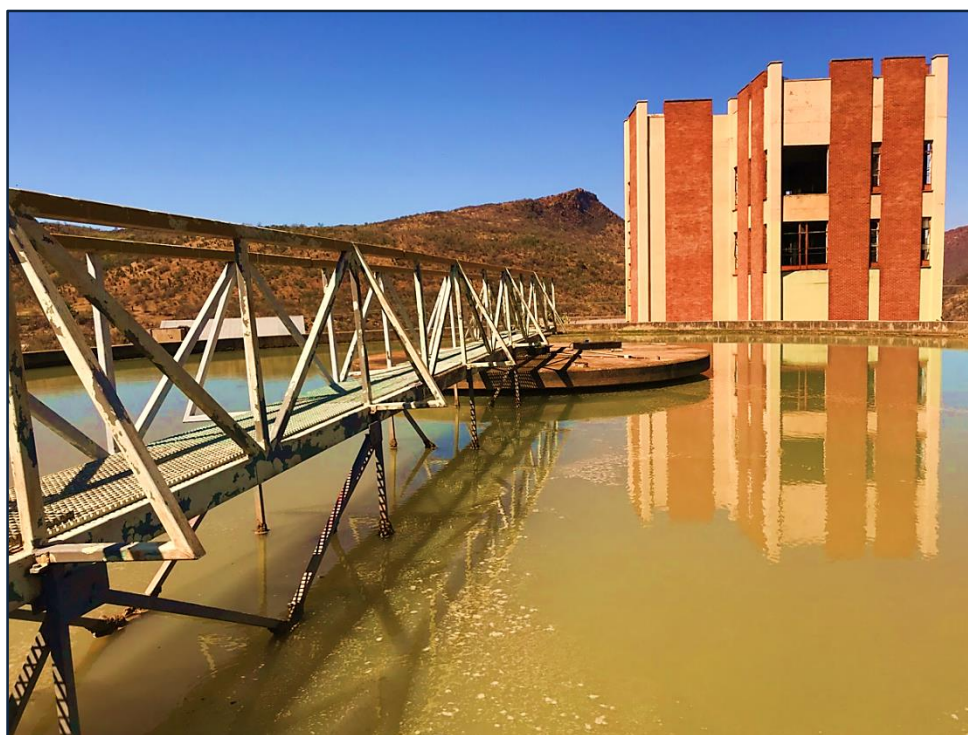

Figure 13.23 Ezakheni Water Treatment Plant (unknown date).

The Ezakheni Water Treatment Plant Supply System is shown in **Figure 13.24** and **Figure 13.25**.

²⁶ The Thukela Water Project Feasibility Study reported the capacity as 35 ML/day (DWA 1999: 50).

Table 13.19 Characteristics of the Ezakheni WTP.

| | |
|---|--|
| WTP Name: | Ezakheni WTP |
| System: | Upper uThukela System |
| Maximum Design Capacity: | 32 Mℓ/day |
| Current Utilisation (Mar 2020): | 30 Mℓ/day |
| Raw Water Source | uThukela River Weir |
| Raw Water Storage Capacity: | Unknown |
| Raw Water Supply Capacity: | Currently up to 42 Mℓ/day, as at March 2020) |
| Pre-Oxidation Type: | N/A |
| Primary Water Pre-Treatment Chemical: | One Polymetric (Polyelectrolyte) Coagulant – Sudfloc 3456 |
| Total Coagulant Dosing Capacity: | Duty standby pumps with capacity of 30ℓ/hr and 27ℓ/hr under normal operations. In the event of high raw water turbidity, both pumps must be operational and thus no standby will be available. |
| Rapid Mixing Method: | Hydraulic weir |
| Clarifier Type: | 4x Rectangular Dortmund + 1 x Clariflocculator |
| Number of Clarifiers: | 5 (all functional) |
| Total Area of all Clarifiers: | Old Clarifier = 491 m ² New Clarifiers = 293 m ² (73 m ² x 4) Total Clarification Area = 784 m ² |
| Total Capacity of Clarifiers: | For a design upflow rate of 2 m/hr, clarification capacity is: Old Clarifier = 23.6 Mℓ/day New Clarifiers = 14.1 Mℓ/day Total Capacity = 37.7 Mℓ/day |
| Filter Type: | Candy Rapid Gravity Filters |
| Number of Filters: | 10 (6 old + 4 new) (Of the 4 new, 3 are functional) |
| Filter Floor Type | Unknown |
| Total Filtration Area of all Filters | Old Filters = 152 m ² (38 m ² x 4) New Filters = 156 m ² (26 m ² x 6) Total Filtration Area = 308 m ² (all run manually) |
| Total Filtration Design Capacity of all Filters: | For a design filtration rate of 5 m/hr, the filters can treat a capacity of 1 540 m ³ /hr or 37 Mℓ/day. |
| Total Capacity of Backwash Water Tanks: | Unknown |
| Total Capacity of Sludge Treatment Plant: | There is no sludge treatment |
| Capacity of Used Washwater System: | 0 (no pumps installed as yet) |
| Primary Post Disinfection Type: | Chlorine gas |
| Disinfection Dosing Capacity: | 10 kg/hr Chlorinator |
| Disinfectant Storage Capacity: | 1 ton cylinders. Sufficient storage available. |
| Total Treated Water Storage Capacity: | 2 x onsite reservoirs 4 Mℓ + 2.6 Mℓ ^a |

^a Confirmed through onsite measurements by Umgeni Water staff

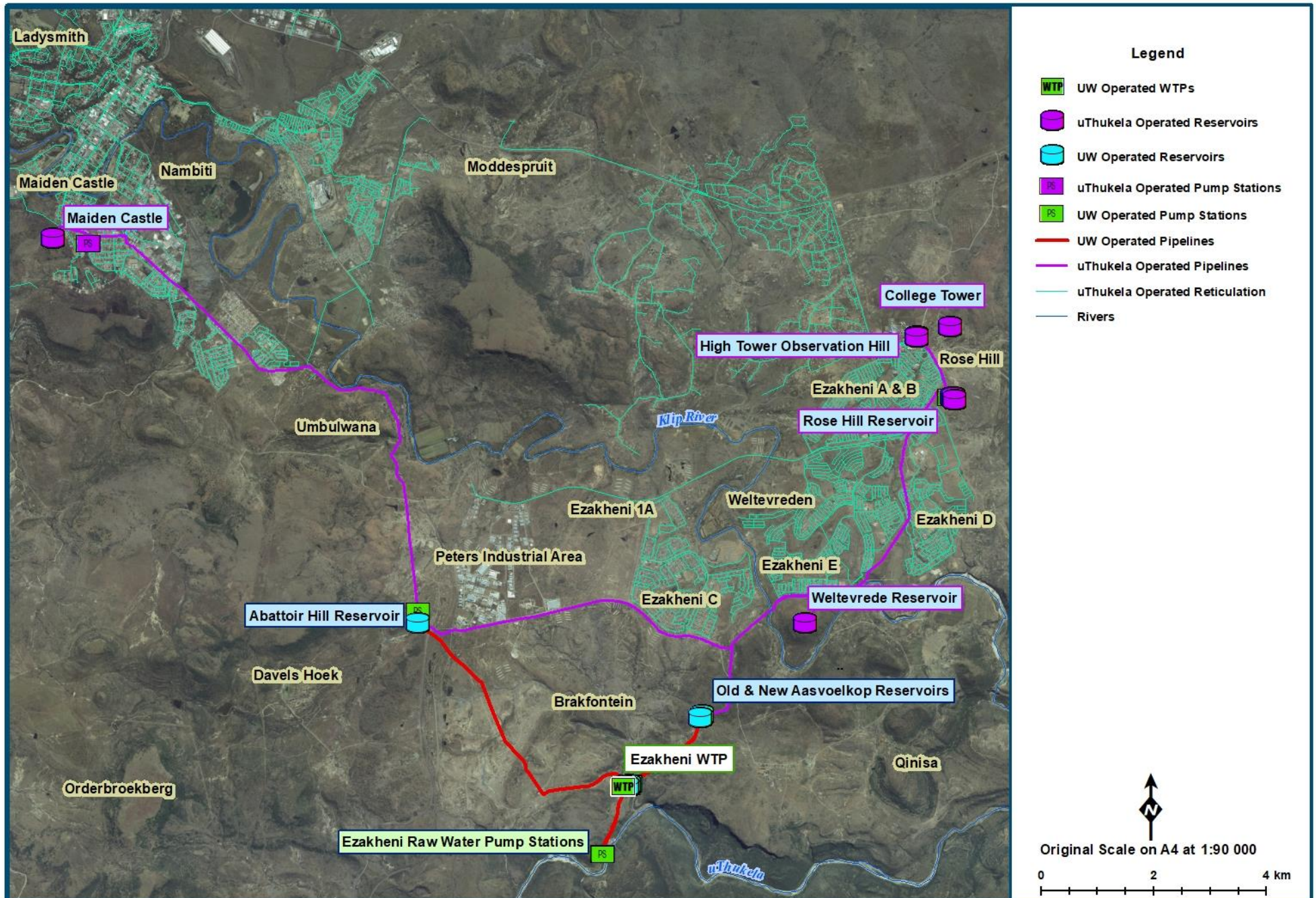

Figure 13.24 Ezakheni WTP Supply System layout (NGI 2014; Umgeni Water 2019).

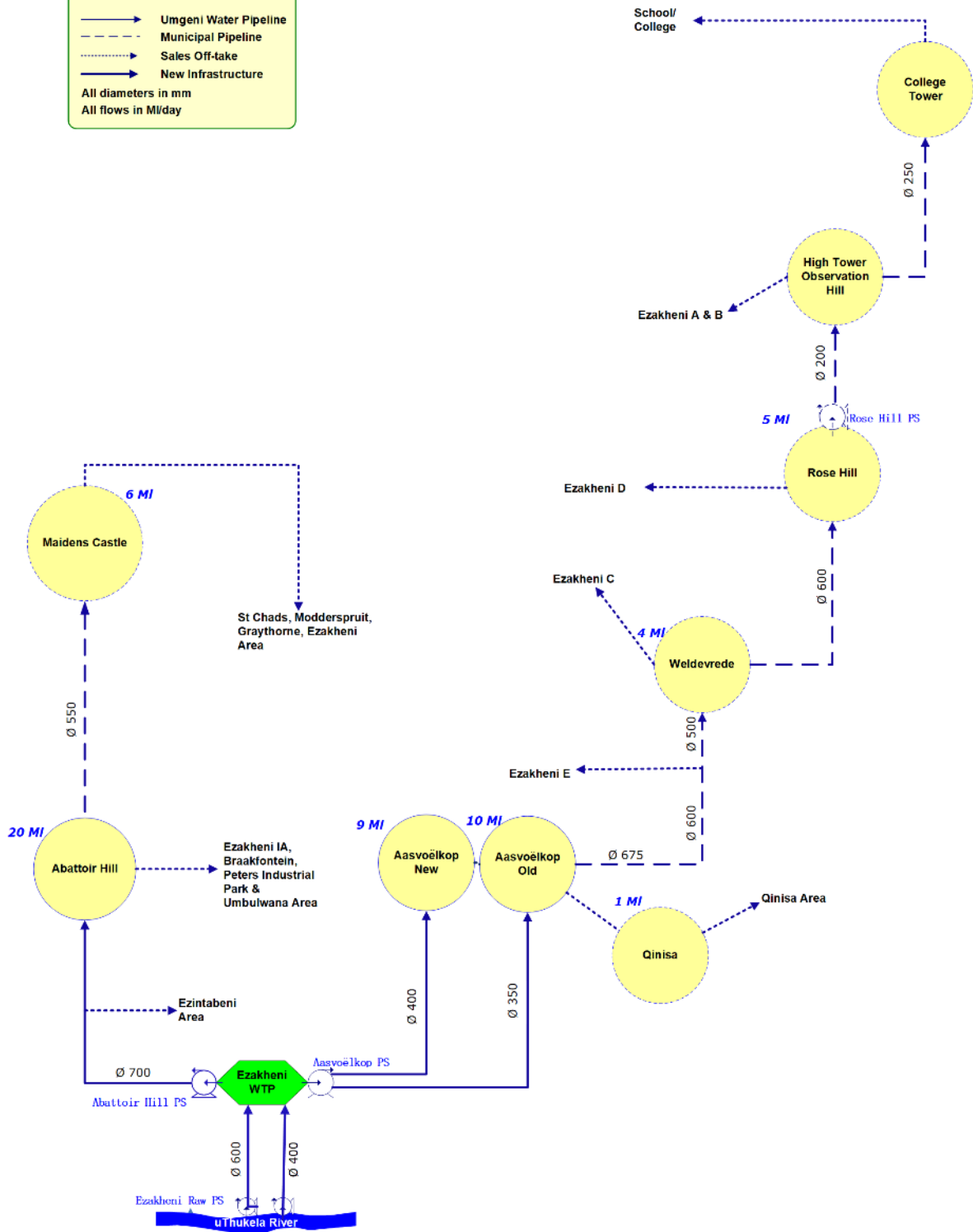
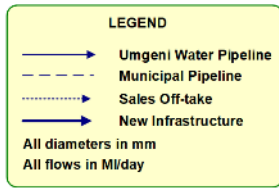

Figure 13.25 Ezakheni WTP Supply System schematic.

Raw water is pumped from the raw water pump station (**Table 13.20**) at the uThukela River Weir via a 1.35 km long, 600 mm diameter steel rising main and a 1.26 km long, 400 mm diameter steel rising main (**Table 13.21**) to the Ezakheni WTP. The raw water pump station can house 6 pumps (3 APE turbine and 3 Flygt submersible pumps), although some pumps have been out of commission at any given time. UW is currently using 2 APE pumps and 1 Flygt pump) which provides approximately 42 Mℓ/day²⁷. The Ezakheni WTP is located on the northern bank of the uThukela River at an elevation of 930 mASL (DWAf 1998: 50). UW is in the process of purchasing and installing new raw water pumps (APE turbine pumps), which could provide up to a maximum of 66 Mℓ/day. A number of other facets of the plant would also have to be upgraded in the near future in order for UW to fully make use of the extra raw water.

The potable water pump station at the WTP houses pump sets that supply two separate sub-systems as listed below:

- The Aasvoëlkop Pump Station at the WTP supplies potable water to Ezakheni's Aasvoëlkop Old Reservoir (10 Mℓ) and Aasvoëlkop New Reservoir (9 Mℓ) via a 2 km long, 400 mm diameter steel pipe and a 2 km long, 350 mm diameter steel pipe for distribution to the areas of Qinisa, Ezakheni E, Ezakheni C, Ezakheni D, Ezakheni A and B and the Ezakheni School/College; and
- The Abattoir Hill Pump Station at the WTP supplies potable water to the Abattoir Hill Reservoir (20 Mℓ) via a 5.5 km long, 700 mm diameter steel pipe for distribution to the areas of Ezintabeni, Ezakheni IA, Braakfontein, Peters Industrial Park, Umbulwana Area, part of St Chads, Modderspruit, Graythorne, Aloe Park and Acaciaville.

(DWAf 1998: 50; Umgeni Water 2016: database).

The uThukela District Municipality then distributes the potable water from the Aasvoëlkop and Abattoir Hill Reservoirs through a system of distribution and terminal reservoirs (which includes the Maidens Castle Reservoir from the Abattoir Hill Reservoir and the Weltevreden and Rosehill Reservoirs from the Aasvoëlkop Reservoirs) to the respective communities as shown in **Figure 12.33**. A number of water meters should be installed at strategic points within the WTP and on the outgoing pipelines in order to assist with the necessary water balances and water demand management. This task is being planned by UW. Numerous leaks have been identified on the bulk pipelines and secondary bulk pipelines. uThukela DM and UW are in the process of planning repairs on these pipelines, as well as the repair or installation of isolating valves and scour valves.

The reservoir, pump station and pipeline details are summarised in **Table 13.22**, **Table 13.23** and **Table 13.24**.

²⁷ Personal communication, Yovesh Danilala, Operations, UW, North West Region (20 March 2020)

Table 13.20 Pump details: Ezakheni Raw Water Pump Station.

| System | Pump Station Name | Number of Pumps | | Pump Description | Supply From | Supply To | Static Head (m) | Duty Head (m) | Duty Capacity (Mℓ/day) Per pump |
|----------------|-----------------------|----------------------|-------------------------|-------------------------|---------------------|---------------|-----------------|---------------|---------------------------------|
| | | Number of Duty Pumps | Number of Standby Pumps | | | | | | |
| Upper uThukela | Raw Water Abstraction | 3 | 0 | APE Turbine Pumps | uThukela River Weir | Head of Works | 50 | Unknown | 13 |
| Upper uThukela | Raw Water Abstraction | 3 | 0 | Flygt submersible pumps | uThukela River Weir | Head of Works | 50 | Unknown | 10.3 |

Table 13.21 Pipeline details: Ezakheni Raw Water Rising Mains.

| System | Pipeline Name | From | To | Length (km) | Nominal Diameter (mm) | Material | Capacity (Mℓ/day) | Age (years) |
|----------------|---------------|-----------------------|---------------------------------|-------------|-----------------------|----------|-------------------|-------------|
| Upper uThukela | Rising Main | Raw Water Abstraction | Raw Water Inlet – Head of Works | 1.35 | 600 | Steel | 36.7* | 26 |
| Upper uThukela | Rising Main | Raw Water Abstraction | Raw Water Inlet – Head of Works | 1.26 | 400 | Steel | 21.7** | 15* |

* Based on a velocity of 1.5 m/s

** Based on a velocity of 2 m/s

Table 13.22 Reservoir details: Ezakheni WTP.

| System | Reservoir Site | Reservoir Name | Capacity (Mℓ) | Function | TWL (mASL) | FL (mASL) |
|----------------|----------------|------------------|---------------|----------|------------|-----------|
| Upper uThukela | Ezakheni | Abattoir Hill | 20 | Command | 1060.5* | 1055 |
| Upper uThukela | Ezakheni | Aasvoëlkop (New) | 9 | Command | 1087* | 1080 |
| Upper uThukela | Ezakheni | Aasvoëlkop (Old) | 10 | Command | 1087* | 1080.5 |

* These levels are estimated based on the measured height of the respective reservoirs

Table 13.23 Pump details: Ezakheni WTP.

| System | Pump Station Name | Number of Pumps | | Pump Description | Supply From | Supply To | Static Head (m) | Duty Head (m) | Duty Capacity (Mℓ/day) |
|----------------|----------------------------|----------------------|-------------------------|------------------|--------------|-------------------------|-----------------|---------------|------------------------|
| | | Number of Duty Pumps | Number of Standby Pumps | | | | | | |
| Upper uThukela | Aasvoëlkop Pump Station | 4 | 1 | KSB WKLn 150/5 | Ezakheni WTP | Aasvoëlkop Reservoir | 156 | 187 | 6.48* |
| Upper uThukela | Abattoir Hill Pump Station | 3 | 1 | KSB WKLn 150/4 | Ezakheni WTP | Abattoir Hill Reservoir | 136.5 | 148 | 6.48 |

*Water meter not functional. Flow rate provided by hydraulic calculations.

Table 13.24 Pipe details: Ezakheni WTP Supply System.

| System | Pipeline Name | From | To | Length (km) | Nominal Diameter (mm) | Material | Capacity (Mℓ/day) | Age (years) |
|----------------|---------------|----------------------------|-------------------------|-------------|-----------------------|----------|-------------------|-------------|
| Upper uThukela | Aasvoëlkop | Aasvoëlkop Pump Station | Aasvoëlkop Reservoir | 2 | 400 | steel | 16.3** | 47 |
| Upper uThukela | Aasvoëlkop | Aasvoëlkop Pump Station | Aasvoëlkop Reservoir | 2 | 300 | steel | 9.2** | Unknown |
| Upper uThukela | Abattoir Hill | Abattoir Hill Pump Station | Abattoir Hill Reservoir | 5.5 | 700 | steel | 49.9** | 31 |

** Based on a velocity of 1.5 m/s

(c) Tugela Estates Water Treatment Plant and Supply System and the uMhlumayo Borehole Supply System

The Tugela Estates WTP site is unique in that two separate water supply systems, the Tugela Estates WTP, built in the early 2000s²⁸ (Figure 13.26) and the uMhlumayo Borehole System, constructed in 2006¹⁶ (Figure 13.27), are located immediately adjacent to one another (Figure 13.28 and Figure 13.29).



Figure 13.26 Tugela Estates Water Treatment Plant (Umgeni Water 2019).



Figure 13.27 uMhlumayo Pump Station (Umgeni Water 2019).

²⁸ Personal communication, Mr Thokozani Nzamo, Process Controller, Umgeni Water Operations (20 May 2019).

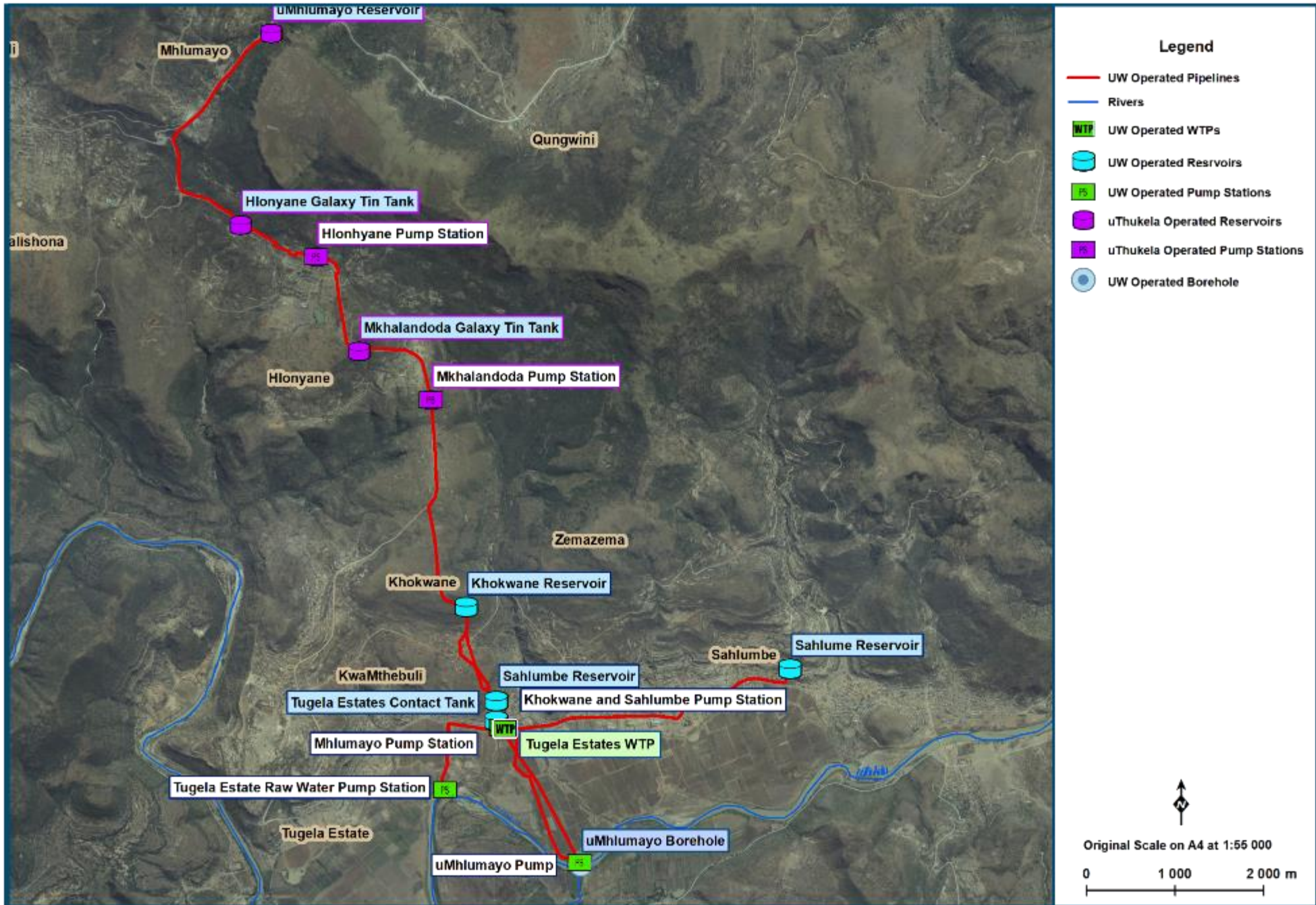

Figure 13.28 Tugela Estates WTP and uMhlumayo Borehole Supply System layout (NGI 2014; Umgeni Water 2019).



Figure 13.29 uMhlamayo Pump Station adjacent to the Tugela Estates WTP (KZN DoT 2017; NGI 2014).

The Tugela Estates WTP (**Figure 13.26; Table 13.25**), located approximately 1.8 km upstream of the confluence of the uThukela River and the Bushmans River, abstracts raw water from the uThukela River via two 150 mm diameter steel pipelines to the Tugela Estates Raw Water Pump Station (**Figure 13.30**). The raw water pump station includes one duty and one standby pump (**Table 13.26**). The Umgeni Water 2017 and 2019 Process Audits and the 2019 Water Loss Investigation indicated that the standby pump had been removed for repairs, but has since been reinstated. From the Tugela Estates Raw Water Pump Station, the water is pumped via a 150 mm diameter Klambon Steel Pipe (**Table 13.27**) to “four raw water holding tanks which are 10 000 ℓ polyethylene tanks which are encased with wire reinforced concrete” (Umgeni Water 2017: 6, **Figure 13.31; Table 13.28**). Water is fed under gravity via a 100 mm diameter steel pipe from these holding tanks to a 1.2 Mℓ/day prefabricated package WTP



Figure 13.30 Tugela Estates Raw Water Pump Station (Umgeni Water 2019).



Figure 13.31 Tugela Estates Raw Water Holding Tanks (Umgeni Water 2019).

Table 13.25 Characteristics of the Tugela Estates WTP.

| | |
|---|---|
| WTP Name: | Tugela Estates |
| System: | Upper uThukela |
| Maximum Design Capacity: | 1.2 Mℓ/day |
| Current Utilisation (March 2020): | 0.45 Mℓ/day |
| Raw Water Source | Run of river abstraction on the uThukela River |
| Raw Water Storage Capacity: | 4 x 10m ³ Tanks |
| Raw Water Supply Capacity: | N/A |
| Pre-Oxidation Type: | N/A |
| Primary Water Pre-Treatment Chemical: | Polymeric (Polyelectrolyte) Coagulant Sudfloc 3456 |
| Total Coagulant Dosing Capacity: | Old System: 25ℓ/hr Dosing Pump with No Standby New System (to be connected): 2 x 12ℓ/hr Dosing Pumps (Duty/Standby) |
| Rapid Mixing Method: | Rapid mix is done inline. Flocculation column is for slow mixing. |
| Clarifier Type: | Glass reinforced plastic (GRP) clarifiers |
| Number of Clarifiers: | 5 |
| Total Area of all Clarifiers: | Total Clarifier Area = 35 m ² (5 x 3 m ²) |
| Total Capacity of Clarifiers: | Total Clarifier Volume = 55 m ³ (5 x 11 m ³) |
| Filter Type: | Pressure Filters |
| Number of Filters: | 2 |
| Filter Floor Type | Unknown |
| Total Filtration Area of all Filters | 8 m ² |
| Total Filtration Design Capacity of all Filters: | For a design filtration rate of 6.25 m/hr, total capacity filters are able to treat 50 m ³ /hr or 1.2 Mℓ/day. |
| Total Capacity of Backwash Water Tanks: | No backwash water tanks, clarified water is used for backwashing which is insufficient for one complete wash. Clarified water holding tank capacity is 5 m ³ . |
| Total Capacity of Sludge Treatment Plant: | No sludge treatment, sludge to the river. |
| Capacity of Used Washwater System: | Unknown |
| Primary Post Disinfection Type: | Sodium Hypochlorite |
| Disinfection Dosing Capacity: | Duty/standby dosing pumps = 7.6 ℓ/hr each |
| Disinfectant Storage Capacity: | Supplied in 25 ℓ drums, sufficient storage capacity in new building. |
| Total Treated Water Storage Capacity: | Onsite storage capacity is 2 x 10 m ³ Jojo tanks |

Table 13.26 Pump details: Tugela Estates Raw Water Pump Station.

| System | Pump Station Name | Number of Pumps | | Pump Description | Supply From | Supply To | Static Head (m) | Duty Head (m) | Duty Capacity (Mℓ/day) |
|----------------|--------------------------------------|----------------------|-------------------------|----------------------------|--------------------------------------|--------------------|-----------------|---------------|------------------------|
| | | Number of Duty Pumps | Number of Standby Pumps | | | | | | |
| Upper uThukela | Tugela Estates Raw Water Abstraction | 1 | 1 | KSB WKLn 80/5 ^a | Tugela Estates Raw Water Abstraction | Tugela Estates WTP | 32 | Unknown | 1.4 |

^a Impeller diameter = 220 (205) mm (Umgeni Water May 2019 Water Loss Investigation).

Table 13.27 Pipeline details: Tugela Estates Raw Water Rising Main.

| System | Pipeline Name | From | To | Length (km) | Nominal Diameter (mm) | Material | Capacity (Mℓ/day) | Age (years) |
|----------------|--------------------------|---|--|-------------|-----------------------|----------|-------------------|-------------|
| Upper uThukela | Tugela Estates Raw Water | Thukela Estates Raw Water Pump station (uThukela River) | Tugela Estates Raw Water Holding Tanks | 1.5 | 140 | uPVC CL6 | 2.3 ^a | 18 |

^a Based on a velocity of 1.5 m/s

Table 13.28 Reservoir details: Tugela Estates Reservoirs.

| System | Reservoir Site | Reservoir Name | Capacity (Mℓ) | Function | TWL (mASL) | FL (mASL) |
|----------------|--|--|-------------------|----------|------------|-----------|
| Upper uThukela | Tugela Estates Raw Water Holding Tanks | Tugela Estates Raw Water Holding Tanks | 0.04 ^a | Unknown | Unknown | Unknown |
| Upper uThukela | Khokwane Reservoir | Khokwane Reservoir | 0.5 | Unknown | Unknown | 915 |
| Upper uThukela | Sahlumbe Reservoir | Sahlumbe Reservoir | 0.4 | Unknown | Unknown | 709 |

^a Four 10 000 ℓ polyethylene tanks.

The Umgeni Water Process Audit describes the treatment process as follows:

“The water is coagulated in-line before entering a flocculation column (**Figure 13.32**). The flocculated water flows into five clarifiers (**Figure 13.32**). Clarified water is stored in a buffer tank and is pumped into two pressure filters. The filtrate is disinfected with sodium hypochlorite and is stored in two on-site reservoirs (**Figure 13.33**).”

(Umgeni Water 2017: 2)



Figure 13.32 Tugela Estates WTP clarifiers (Umgeni Water 2019).



Figure 13.33 Tugela Estates WTP reservoirs (Umgeni Water 2019).

Two 80 mm diameter HDPE pipelines convey the water to two on-site reservoirs (**Figure 13.33; Table 13.28**). A 100 mm diameter steel pipeline transports the potable water from the clear water reservoir to the Khokwane Pump Station (**Figure 13.34; Table 13.29**) whilst an 80 mm diameter steel pipeline conveys the potable water from the clear water reservoir to the Sahlumbe Pump Station (**Figure 13.34; Table 13.29**).



Figure 13.34 Khokwane Pump Station and Sahlumbe Pump Station on the Tugela Estates WTP site (Umgeni Water 2019).

Water is pumped from the Khokwane Pump Station via an 85 mm diameter steel pipeline (**Table 13.30**) to the 0.5 Mℓ Khokwane Reservoir (**Table 13.28**) which supplies the Khokwane community. Water is pumped from the Sahlumbe Pump Station via an 85 mm diameter steel pipeline (**Table 13.30**) to the 0.4 Mℓ Sahlumbe Reservoir (**Table 13.28**) which supplies the Sahlumbe community.

A schematic of the Tugela Estates WTP Supply System is illustrated in **Figure 13.35**.

Adjacent to the Tugela Estates WTP, is the uMhlumayo High Lift Pump Station which abstracts raw water from a borehole (sand aquifer) next to the uThukela River. Raw water is pumped from the raw water (low lift) pump station at the borehole via a 150 mm diameter Klambon Steel Pipe (**Table 13.31**) to the uMhlumayo High Lift (HL) Pump Station. There is a pressure filter on this pipeline but it is bypassed. The uMhlumayo High Lift Pump Station consists of two pumps (**Table 13.32**). The water is dosed with sodium hypochlorite and pumped via a 100 mm diameter steel pipeline to the sump/reservoir of the Mkhalandoda Pump Station. Water is pumped from the Mkhalandoda Pump Station to the Hlonyane Pump Station, also feeding the Mkhalandoda Steel Tank along the way (via a branch off/tee). The Mkhalandoda Steel Tank is currently not in use, and is bypassed as it has sustained damage (and is yet to be repaired). Water is then pumped from the Hlonyane Pump Station to the uMhlumayo reservoir, also feeding the Hlonyane Steel Tank along the way (via a branch off/tee). uMhlumayo Reservoir (**Table 13.33**). This uMhlumayo Borehole System has a design capacity of 1.4 Mℓ/day and supplies the areas of uMhlumayo, Oqungweni, Bhaza, Hlonyane, Mkhalandoda and Ghobo (**Figure 13.28**). A schematic of the uMhlumayo Borehole Supply System is shown in **Figure 13.36**.

Table 13.29 Pump details: Tugela Estates WTP Pump Stations.

| System | Pump Station Name | Number of Pumps | | Pump Description | Supply from | Supply To | Static Head (m) | Duty Head (m) | Duty Capacity (Ml/day) | Impeller Diameter** (mm) |
|----------------|-----------------------|----------------------|-------------------------|-----------------------------|-----------------------|--------------------|-----------------|---------------|------------------------|--------------------------|
| | | Number of Duty Pumps | Number of Standby Pumps | | | | | | | |
| Upper uThukela | Khokwane Pump Station | 1 | | KSB WKLn 80/5 | Khokwane Pump Station | Khokwane Reservoir | 260 | 275 | 0.53 | 220 (205) |
| Upper uThukela | Khokwane Pump Station | | 1 | Grundfos CR32-14 A-F-A-E-HQ | Khokwane Pump Station | Khokwane Reservoir | 260 | 218.1*** | 0.72 | Unknown TBC |
| Upper uThukela | Sahlumbe Pump Station | 1 | | KSB WKLn 65/5 | Sahlumbe Pump Station | Sahlumbe Reservoir | 197* | 220 | 1.44 | Full size 192 |
| Upper uThukela | Sahlumbe Pump | | 1 | KSB WKLn 65/5 | Sahlumbe Pump Station | Sahlumbe Reservoir | 197* | 220 | 1.44 | 192 |

*An approximation

** (Umgeni Water May 2019 Water Loss Investigation)

***Duty head indicated on pump plate is lower than the static head. Pump to be replaced.

Table 13.30 Pipeline details: Tugela Estates Rising Mains.

| System | Pipeline Name | From | To | Length (km) | Nominal Diameter (mm) | Material | Capacity (Ml/day) | Age (years) |
|----------------|----------------------|----------------------------------|-----------------------------|-------------|-----------------------|----------|-------------------|-------------|
| Tugela Estates | Sahlumbe Rising Main | Sahlumbe Pump Station | Sahlumbe Command Reservoir | 1.0 | 85 | Klambon | 1.0** | Unknown |
| Tugela Estates | Khokwane Rising Main | Khokwane Pump Station | Khokwane Command Reservoir | 3.0 | 85 | Klambon | 2.3** | Unknown |
| Tugela Estates | Rising Main | uMhlamayo High Lift Pump Station | Command Reservoir uMhlamayo | 10.7 | 200 | Klambon | 4.0** | Unknown |

** Based on a velocity of 1.5 m/s

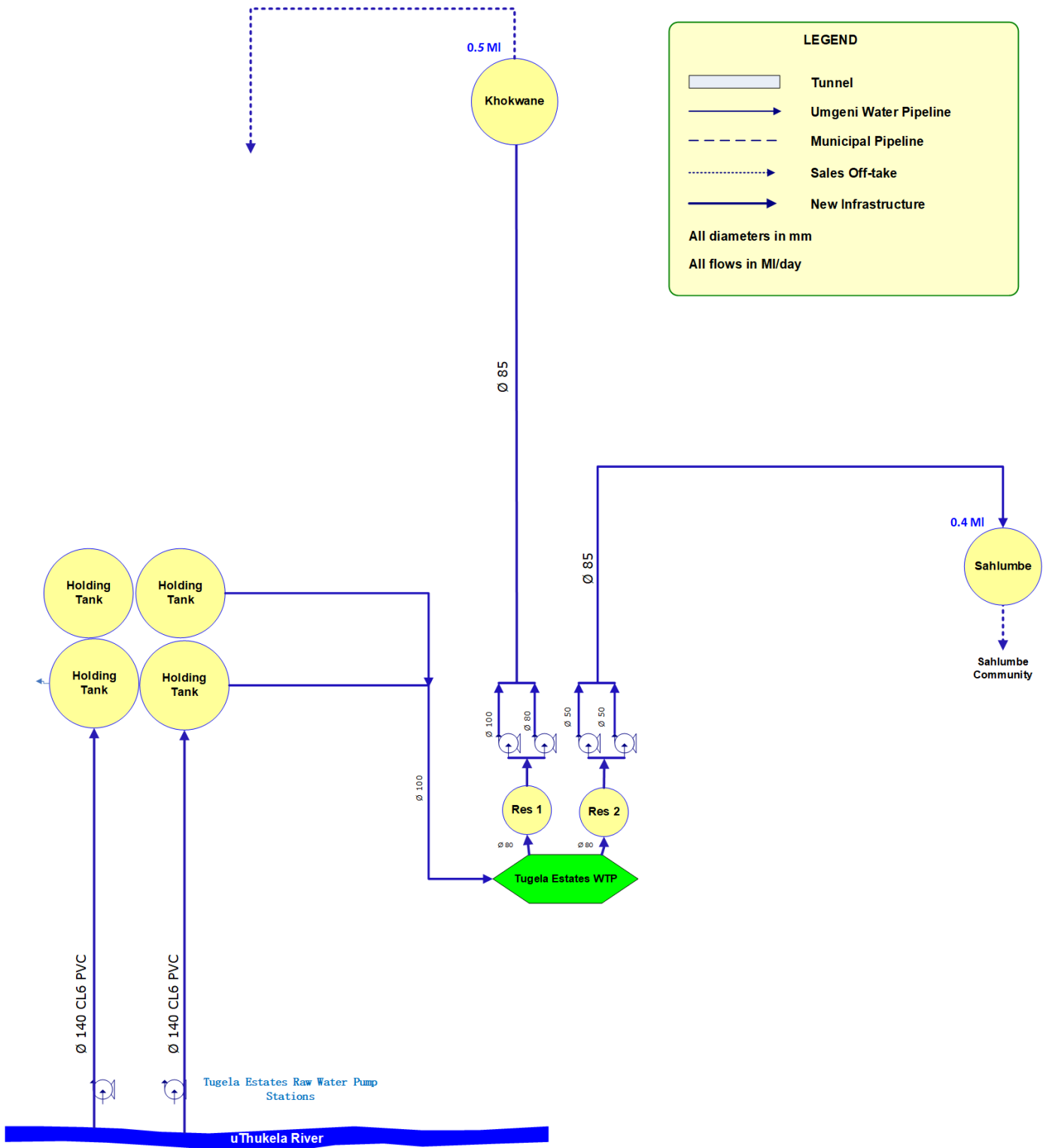

Figure 13.35 Tugela Estates WTP Supply System schematic.

Table 13.31 Pipeline details: uMhlamayo Raw Water Pipeline.

| System | Pipeline Name | From | To | Length (km) | Nominal Diameter (mm) | Material | Capacity (Ml/day) | Age (years) |
|----------------|--|----------------------------------|--------------------------------|-------------|-----------------------|----------|-------------------|-------------|
| Upper uThukela | uMhlumayo Raw Water | uMhlamayo Borehole | Sump of uMhlumayo Pump Station | 1.5 | 150 | Klambon | 2.0 | 10 |
| Tugela Estates | Rising Main (with booster pump stations at Mkhalandoda and Hlonyane) | uMhlamayo High Lift Pump Station | Command Reservoir uMhlumayo | 10.7 | 200 | Klambon | 4.0** | Unknown |

* Based on a velocity of 1.3 m/s

Table 13.32 Pump details: uMhlumayo Pump Station.

| System | Pump Station Name | Number of Pumps | | Pump Description | Supply From | Supply To | Static Head (m) | Duty Head (m) | Duty Capacity (Ml/day) |
|----------------|------------------------|----------------------|-------------------------|------------------|-------------------------------------|----------------------------------|-----------------|---------------|------------------------|
| | | Number of Duty Pumps | Number of Standby Pumps | | | | | | |
| Upper uThukela | uMhlumayo Pump Station | 1 | | KSB WKLn | uMhlumayo Pump Station sump, at WTP | Sump of Mkhalandoda Pump Station | 278 | 328 | 1.6 |
| Upper uThukela | uMhlumayo Pump Station | | 1 | KSB WKLn | uMhlumayo Pump Station sump, at WTP | Sump of Mkhalandoda Pump Station | 278 | 328 | 1.6 |

Table 13.33 Reservoir details: uMhlumayo Reservoirs.

| System | Reservoir Site | Reservoir Name | Capacity (Mℓ) | Function | TWL (mASL) | FL (mASL) |
|----------------|------------------------|------------------------|---------------|---|------------|-----------|
| Upper uThukela | uMhlumayo Pump Station | uMhlumayo Contact Tank | Unknown | Storage, Sump and chlorine contact tank | Unknown | 669 |
| Upper uThukela | Mkhalandoda Reservoir | Mkhalandoda Reservoir | Unknown | Distribution Reservoir | Unknown | Unknown |
| Upper uThukela | Hlonyane Reservoir | Hlonyane Reservoir | Unknown | Distribution Reservoir | Unknown | Unknown |
| Upper uThukela | uMhlumayo Reservoir | uMhlumayo Reservoir | Unknown | Distribution Reservoir | Unknown | Unknown |

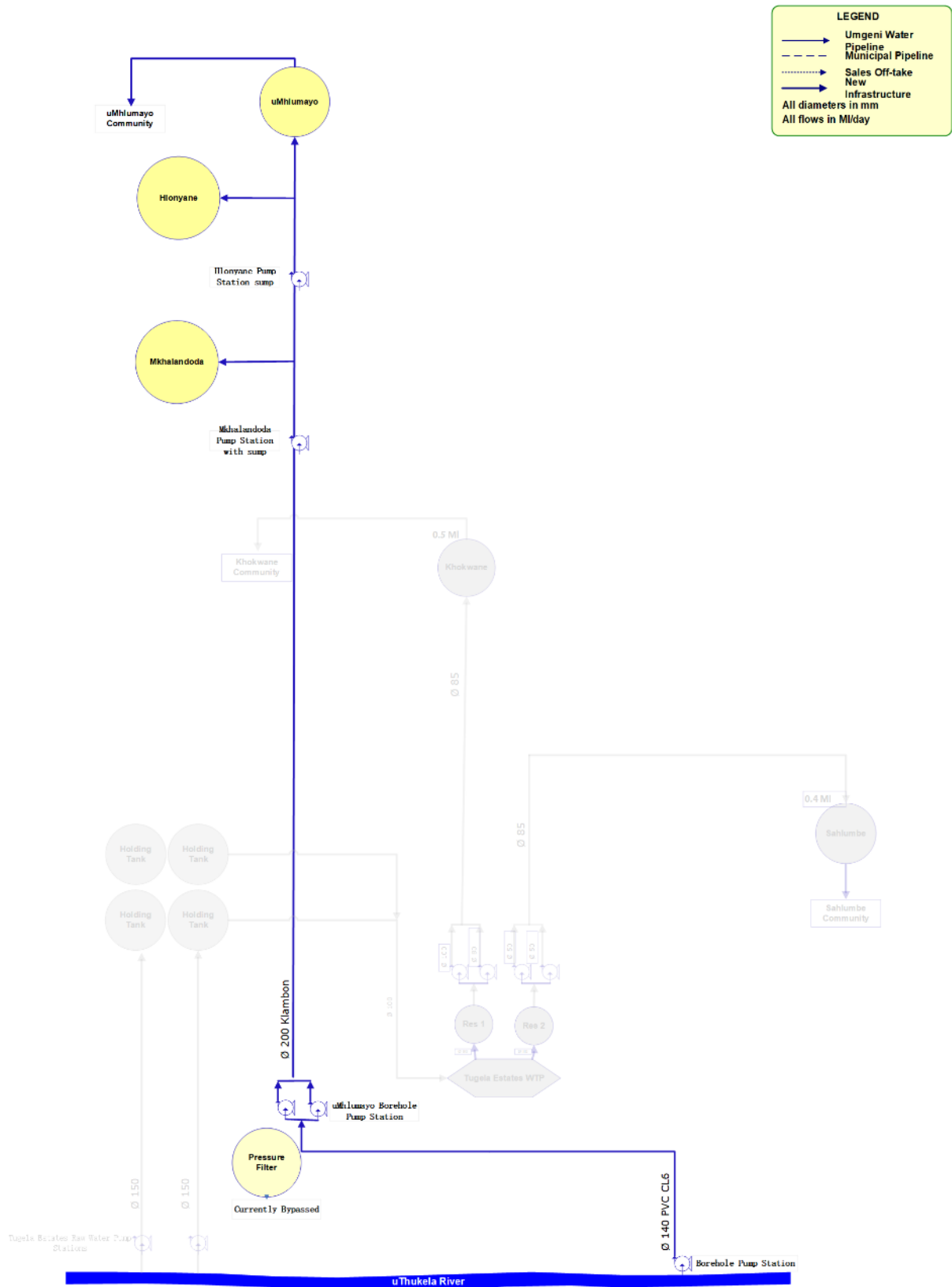

Figure 13.36 uMhlumayo Borehole Supply System schematic.

The supply to the communities is via standpipes at the basic level of supply, but on-site investigations carried out by Umgeni Water shows that there are numerous illegal connections with direct supply to yard and house connections. The Tugela Estates WTP has a design capacity of 1.2 Mℓ/day as indicated above and is not operating at full capacity since June 2019 to date (March 2020), producing approximately 350 kℓ/day (due to numerous recurring operational challenges within the plant (aging infrastructure, poor design, theft of water from the plant etc). The demand currently exceeds the design capacity of the treatment plant and water supply to the communities is managed by scheduled water “shedding” from the Sahlumbe and Khokwane reservoirs.

The uMhlumayo Borehole System is currently operating above its design capacity to sustain the demand of the supply area. The total water requirement and availability for the area requires investigation as a new bulk project. Both a booster pump station and reservoirs were recently constructed for a neighbouring settlement, but never commissioned due to lack of water supply (Fitty Park Sundays River Extension Phase 1 Project) uThukela DM have commissioned RHDHV Consulting Engineers in 2020 to undertake a comprehensive study of water supply options to Tugela Estates, uMhlumayo, Fitty Park and immediate surrounds²⁹.

²⁹ Personal communication, Philane Zwane, Project Management Unit, uThukela DM (20 March 2020)

(d) Olifantskop Water Treatment Plant and Supply System

The Olifantskop WTP (**Figure 13.37, Table 13.34**) was built in 1985 to supply water to the Ekuvukeni Water Supply Scheme (**Section 13.2.3 (c)**, DWA 2012: 4 - 5) and is situated adjacent to the Olifantskop Dam (**Figure 13.21, Table 13.15**). The design capacity is 10 Mℓ/day (DWA 2012: 5, Umgeni Water 2017: 4, Umgeni Water 2016: 44), however a current baseline of 8 Mℓ/day is used currently³⁰. Staff at the plant state that the plant has never been able to produce in excess of 8 Mℓ/day³¹. Water meter records are poor due to non-functional water meters. The WTP is currently being refurbished and upgraded by uThukela DM (uTDM), and this refurbishment includes the replacement/repair of the water meters within the plant³².

The Olifantskop WTP supplies water to the areas of Ekuvukeni, Dival, Mhlabathini, Spandikron, Etholeni, Hlathi (Khuenene), Limehill, Mabhekazi, Namakazi, Somshoek, Standford, Uitval, Vaalkop and Waaihoek (**Figure 13.38** and **Figure 13.39**). Water supply to these areas is further supplemented by a series of production boreholes discussed in detail in the latter part of this **Section 13.3.1 (d)**. The layout of the Olifantskop WTP Supply System is illustrated in **Figure 13.38** and **Figure 13.39**.



Figure 13.37 Olifantskop Water Treatment Plant (unknown date).

³⁰ Personal communication, Mr Dan Naidoo, Regional Manager, Umgeni Water (Email correspondence, 7 June 2019).

³¹ Personal communication, Yovesh Danilala & Moses Sibeko (ex-uThukela DM) Operations, UW, North West Region (20 March 2020).

³² The project is scheduled to be completed by August 2020 (uTDM Project Management Unit).

Table 13.34 Characteristics of the Olifantskop WTP.

| | |
|---|--|
| WTP Name: | Olifantskop WTP |
| System: | Upper uThukela |
| Maximum Design Capacity: | 10 Mℓ/day |
| Current Utilisation (April 2019): | 3.5 Mℓ/day |
| Raw Water Source | Olifantskop Dam on the Sundays River |
| Raw Water Storage Capacity: | 379 Mℓ (late 2019) ³³ |
| Raw Water Supply Capacity: | Currently rated at 10 Mℓ/day |
| Pre-Oxidation Type: | N/A |
| Primary Water Pre-Treatment Chemical: | Coagulant is a pre-treatment chemical |
| Coagulant | One Polymeric (Polyelectrolyte) Coagulant Sudfloc 3456 |
| Total Coagulant Dosing Capacity: | Duty Dosing Pump Capacity = 25 ℓ/hr Standby Dosing Pump Capacity = 2.2 ℓ/hr |
| Rapid Mixing Method: | Hydraulic Jump |
| Slow Mixing Method : | Flocculation Channel x 2 |
| Clarifier Type: | Dortmund-type rectangular clarifiers |
| Number of Clarifiers: | 4 |
| Total Area of all Clarifiers: | 436 m ² |
| Total Capacity of Clarifiers: | For a design upflow rate of 1 m/hr, clarifiers are able to treat a capacity of 10.4 Mℓ/day. However, at this flow rate, the clarifiers are not efficient, due to the high solids content of the raw water. Production ≤ 8 Mℓ/day. |
| Filter Type: | Rapid Gravity Sand Filters |
| Number of Filters: | 4 (These are currently being refurbished, in phases). |
| Total Filtration Area of all Filters | 120 m ² |
| Total Filtration Design Capacity of all Filters: | 2.2 m/hr with all filters operational for an inflow of 6.2 Mℓ/day, resulting in filtrate turbidity of ≤1 NTu For a design filtration rate of 4 m/hr, filters are able to treat a capacity of 11.5 Mℓ/day. However, at this flow rate, the filters are not efficient, due to the high solids content of the raw water. |
| Total Capacity of Backwash Water Tanks: | No backwash tanks, final disinfected water is used for backwashing. For a backwash rate of 22.6 m/hr and a rinse stage of 16 minutes, approximately 180 m ³ water is required per backwash. |
| Total Capacity of Sludge Treatment Plant: | All sludge and spent backwash water is discharged to the river. |
| Capacity of Used Washwater System: | N/A |
| Primary Post Disinfection Type: | 70kg chlorine cylinders |
| Disinfection Dosing Capacity: | 4 kg/hr Chlorinator |
| Disinfectant Storage Capacity: | 70kg gas cylinders (sufficient storage for 30 but only 12 cylinders at a time). |
| Total Treated Water Storage Capacity: | 1 x onsite rectangular reservoir. |

³³ Umgeni Water hydrographic survey of Olifantskop dam, late 2019 (379 million m³ due to siltation)

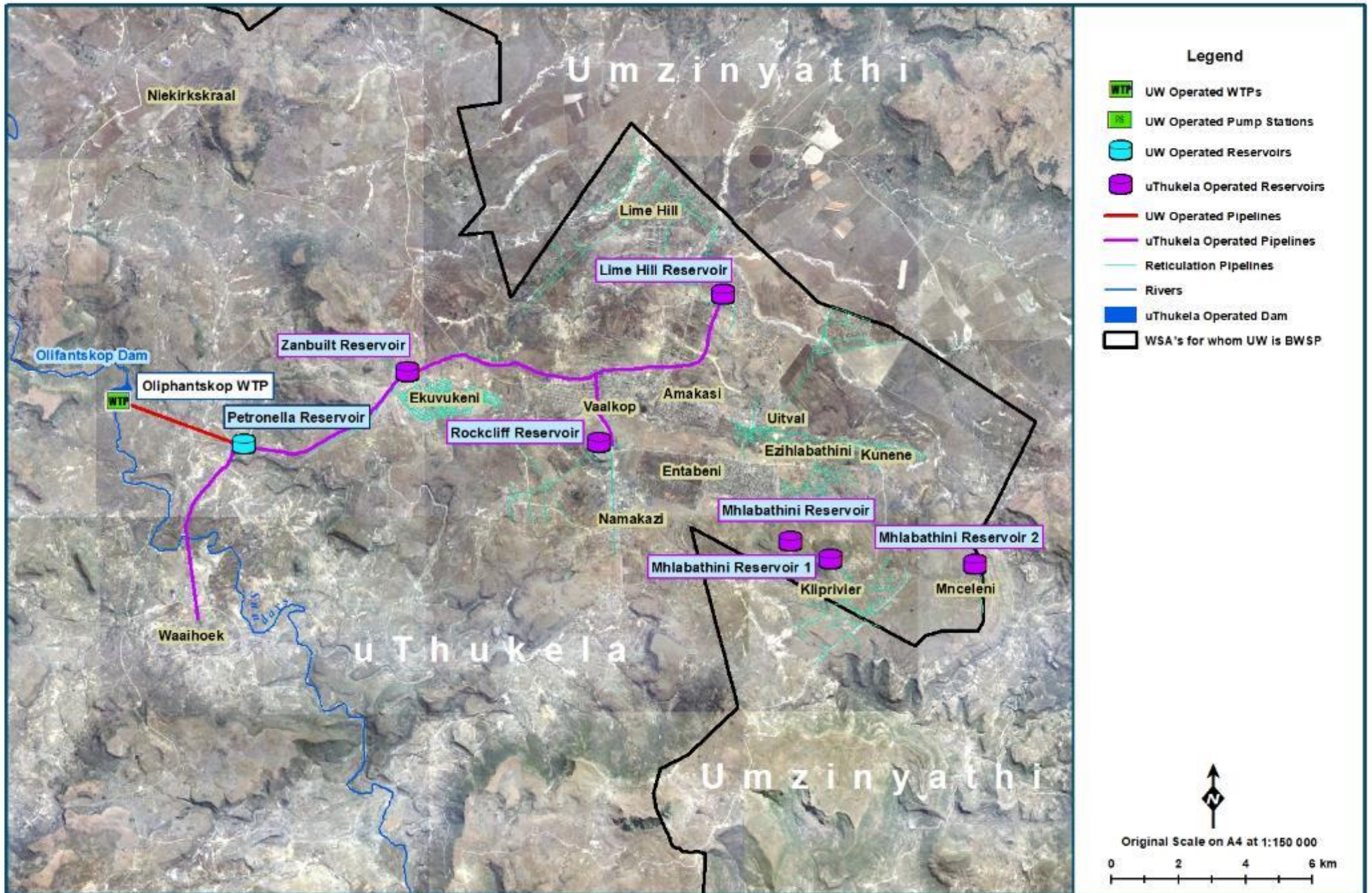

Figure 13.38 Olifantskop WTP Supply System layout (NGI 2014; Umgeni Water 2019).

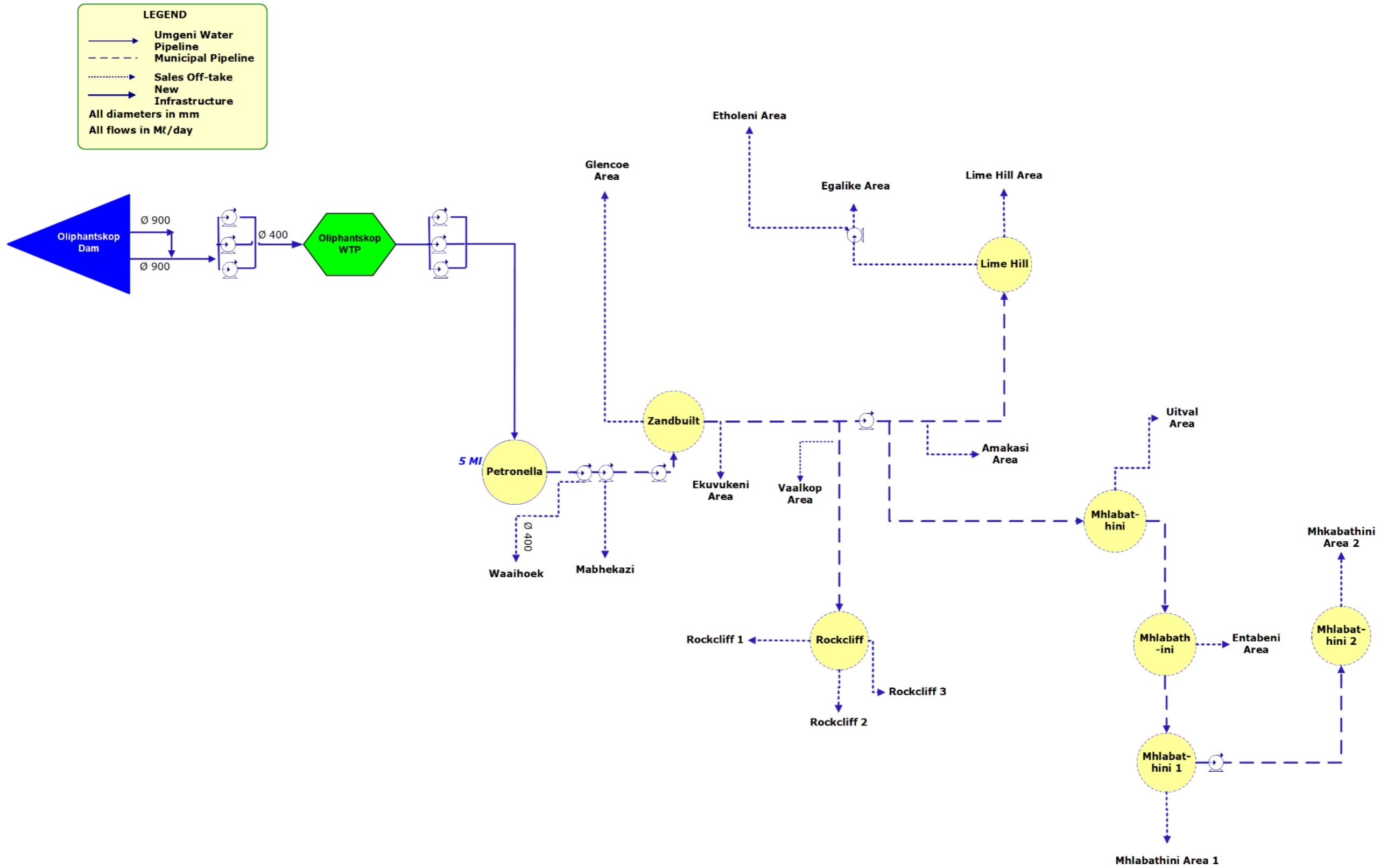

Figure 13.39 Oliphantskop WTP Supply System schematic.

Raw water is abstracted from the Olifantskop Dam via two 900 mm diameter steel pipelines. These reduce to one 900 mm diameter steel pipeline which supplies a raw water pump station adjacent to the dam wall. The pump station operates three raw water pumps (**Figure 13.40; Table 13.35**).



Figure 13.40 Olifantskop raw water pumps (Umgeni Water 2019).

Raw water is pumped from the raw water pump station to the Olifantskop WTP via a 400 mm diameter steel pipeline that is 240m in length (**Table 13.36**). The water treatment comprises:

- a raw water inlet with coagulant dosing;
- two concrete structures that combines two flash mixing;
- two clarifiers with two sand filters on each structure;
- chlorine gas disinfection;
- a clear water reservoir; and
- a high-lift pumping installation.

The Olifantskop WTP process is summarised as follows:

“Water is pumped to the head of works. The coagulant is dosed over a hydraulic jump for rapid mixing. The flow then splits into two identical treatment trains on either side of the main building. Slow mixing is achieved at the flocculation channels. There are four clarifiers (two per side), and the clarified water flows into four rapid gravity sand filters (two per side). Chlorine gas is utilised for disinfection, and the final water is stored in an on-site reservoir.”

(Umgeni Water 2017: 6)

The Umgeni Water 2017 Process Audit reports that the on-site reservoir is a “single reinforced concrete reservoir” (2017: 17). From the potable water reservoir, the water is conveyed to the Olifantskop Clear Water Pump Station (**Figure 13.41**) from which the water is pumped to the 5 Ml Petronella Reservoir (**Figure 13.42; Table 13.38**) via a 3.8 km long, 400 mm diameter steel pipeline (**Table 13.39**). There is a metered off-take to the community located between the Olifantskop Clear Water Pump Station and Petronella Reservoir. The DWA 2012 report indicated that there are two pumps (1 duty pump and 1 standby pump) and that these pumps have a capacity of 300 m³/hour (2012: 6).



Figure 13.41 Olifantskop Clear Water Pump Station (Umgeni Water 2019).



Figure 13.42 Petronella Reservoir (Umgeni Water 2019).

A 400 mm diameter steel pipeline (**Figure 13.43**) conveys the water to the Petronella Reservoir Pump Station (**Figure 13.44**) which consists of two pumps, one of which had been removed at the time of a Water Loss Investigation (May 2019; **Figure 13.45**). Water is pumped from the Petronella Reservoir Pump Station via a 450 mm diameter steel pipeline from which uThukela District Municipality supplies water to:

- Petronella Village;
- Niekerskraal Supply Area;
- Emnambithi Village;
- the Zandbuilt Reservoir/Ekuvukeni Reservoir which supply the Ekuvukeni Area and the Vaalkop Area;
- the Rockcliff Reservoir which supplies Rockcliff Area 1, Rockcliff Area 2, Rockcliff Area 3 and the Amakasi Area;
- the Mahlabathini Reservoir which supplies the Uitval Area, the Entabeni Area, the Mahlabathini Area 1, the Mahlabathini Area 2 and the Sigweje Area.

(Umgeni Water 2016: Ekuvukeni/Lime Hill WSS Schematic Layout)

The five production boreholes mentioned in **Section 13.2.3 (c)** and **Section 13.2.4 (c)** do not supplement the water at the WTP but at the distribution reservoirs as follows:

uThukela DM staff³⁴ have confirmed the status of these 5 production boreholes, and noted that water quality is still poor (high sulphate). They are located in the following areas:

- Limehill: Discharges into Limehill reservoir. Normally only used in Winter. In current use due to low output of the Olifantskop WTP.
- Rockcliff: Not functional at present (and in last few months), as the water table at that point has dropped. It fed the Ekuvukeni reservoir.
- KwaJwili: It feeds the Ekuvukeni reservoir. In current daily use.
- Qhinkhowe: It feeds the Ekuvukeni reservoir. In current daily use. Located close to the Ubusi River. The pump is powered by a diesel engine, and the yield is particularly good.
- Ekuvukeni (central): Use of this borehole has been completely discontinued, due to the poor water quality (it is downstream of a large cemetery).

These boreholes are operated by uThukela DM. The borehole water is not treated before entering the reservoirs, and water quality is dependent on blending with the treated water.

(Umgeni Water Operations 2019: personal communication³⁵)

The 400 mm diameter Ekuvukeni sales meter (**Figure 13.46**) is located within the Petronella Reservoir Pump Station but prior to the Petronella Reservoir pumps.

Water from the Petronella Reservoir is fed under gravity via a 500 mm diameter steel pipeline which reduces to a 400 mm diameter steel pipeline which splits into two pipelines viz.:

- A 400 mm diameter steel pipeline which supplies the Waaihoek area (the Waaihoek sales meter is 150 mm; **Figure 13.47**).
- A 150 mm diameter steel pipeline which supplies the Mabhekazi area and the Mabhekazi Village (the Mabhekazi sales meter is 150 mm; **Figure 13.47**).

³⁴ Personal communication, Mr Lethu Mchunu, Superintendent, uThukela DM, Ekuvukeni (30 March 2020)

³⁵ Personal communication, Mr Thokozani Nzamo, Process Controller, Umgeni Water Operations (21 May 2019).

The Waaihoek and Mabhekazi sales meters are located within the Petronella Reservoir Pump Station.



Figure 13.43 Pipeline servitude from Petronella Reservoir (Umgeni Water 2019).



Figure 13.44 Petronella Reservoir Pump Station (Umgeni Water 2019).



Figure 13.45 Petronella pump as of May 2019 (Umgeni Water 2019).



Figure 13.46 Ekuvukeni sales meter (Umgeni Water 2019).



Figure 13.47 Waaihoek and Mabhekazi sales meters (Umgeni Water 2019).

Table 13.35 Pump details: Olifantskop Raw Water Pump Station.

| System | Pump Station Name | Number of Pumps | | Pump Description | Supply From | Supply To | Static Head (m) | Duty Head (m) | Duty Capacity (ML/day) |
|----------------|------------------------------------|----------------------|-------------------------|-----------------------------|-----------------|-----------------|-----------------|---------------|------------------------|
| | | Number of Duty Pumps | Number of Standby Pumps | | | | | | |
| Upper uThukela | Olifantskop Raw Water Pump Station | 1 | | KSB ETA 150-50 ^a | Olifantskop Dam | Olifantskop WTP | 13* | 50 | 7.95 |
| Upper uThukela | Olifantskop Raw Water Pump Station | 1 | | KSB ETA 150-50 ^a | Olifantskop Dam | Olifantskop WTP | 13* | 50 | 7.95 |
| Upper uThukela | Olifantskop Raw Water Pump Station | | 1 | KSB ETA 150-50 ^b | Olifantskop Dam | Olifantskop WTP | 13* | 50 | 7.95 |

^a Impeller diameter = 413 mm (Umgeni Water May 2019 Water Loss Investigation).

^b Impeller diameter = F/S (Umgeni Water May 2019 Water Loss Investigation).

*An approximation

Table 13.36 Pipeline details: Olifantskop Raw Water Rising Main.

| System | Pipeline Name | From | To | Length (km) | Nominal Diameter (mm) | Material | Capacity (ML/day) | Age (years) |
|----------------|-----------------------------------|------------------------------------|------------------------------------|-------------|-----------------------|----------|-------------------|-------------|
| Upper uThukela | Olifantskop Raw Water Rising Main | Olifantskop Dam | Olifantskop Raw Water Pump Station | 0.01 | 900 | Steel | 82** | Unknown |
| Upper uThukela | Olifantskop Raw Water Rising Main | Olifantskop Raw Water Pump Station | Olifantskop WTP | 0.24 | 400 | Steel | 16** | Unknown |

** Based on a velocity of 1.5 m/s

Table 13.37 Pump details: Olifantskop Clear Water Pump Station.

| System | Pump Station Name | Number of Pumps | | Pump Description | Supply From | Supply To | Static Head (m) | Duty Head (m) | Duty Capacity (Mℓ/day) |
|----------------|--------------------------------------|----------------------|-------------------------|--|-----------------|----------------------|-----------------|---------------|------------------------|
| | | Number of Duty Pumps | Number of Standby Pumps | | | | | | |
| Upper uThukela | Olifantskop Clear Water Pump Station | 1 | | KSB ETAB 200-50 ^b | Olifantskop WTP | Petronella Reservoir | 64* | 78 | 11.88** |
| Upper uThukela | Olifantskop Clear Water Pump Station | 1 | | KSB ETAB 200-50 ^b | Olifantskop WTP | Petronella Reservoir | 64* | 78 | 11.88 |
| Upper uThukela | Olifantskop Clear Water Pump Station | | 1 | KSB split casing by Kantech ^a | Olifantskop WTP | Petronella Reservoir | 64* | 78 | 11.88 |

^a Impeller diameter = unknown (Umgeni Water May 2019 Water Loss Investigation).

^b Impeller diameter = F/S (Umgeni Water May 2019 Water Loss Investigation).

*An approximation

**Only runs one pump at a time

Table 13.38 Reservoir details: Petronella Reservoir.

| System | Reservoir Site | Reservoir Name | Capacity (Mℓ) | Function | TWL (mASL) | FL (mASL) |
|----------------|----------------------|----------------------|---------------|-------------------|------------|-----------|
| Upper uThukela | Petronella Reservoir | Petronella Reservoir | 5Mℓ | Command Reservoir | 963* | 960 |

- TWL need to be verified. Figure based on measured height of the reservoir

Table 13.39 Pipeline details: Petronella Pipeline.

| System | Pipeline Name | From | To | Length (km) | Nominal Diameter (mm) | Material | Capacity (Mℓ/day) | Age (years) |
|----------------|---------------------|-----------------|----------------------|-------------|-----------------------|----------|-------------------|-------------|
| Upper uThukela | Petronella Pipeline | Olifantskop WTP | Petronella Reservoir | 3.8 | 400 | steel | 16** | Unknown |

**Based on a velocity of 1.5 m/s

(e) Zwelisha/Moyeni WTP and Supply Scheme

The Zwelisha Moyeni WTP was built in 2005 to supply water to the Zwelisha Moyeni Water Supply Scheme. The design capacity is rated as 5 ML/day (Blue drop DWS) but is actually regarded as 2.4ML/day by uThukela DM (uTDM), as the new package plant was never used and has not been commissioned to date (May 2020). The plant has been producing approximately 2.4ML/day³⁶ for the last 6 months. 3.3 ML/day is abstracted from a canal and weir system in the Khombe River, a tributary of the Tugela River, where it is treated at the Zwelisha Moyeni WTW. Water meter records are poor due to non-functional water meters. Water loss on the plant is high (desludging and backwashing). This is further exacerbated by the fact that there is no facility for backwash recovery.

The WTW is just above the settlements of Zwelisha Moyeni and is within the Okhahlamba Local Municipality. The co-ordinates of the WTP are:

Latitude (South) -28° 39' 43.14"

Longitude (East) 29° 5' 11.07"³⁷



Figure 13.48 Zwelisha Moyeni WTP (Umgeni Water 2017)

The Zwelisha Moyeni WTP supplies water to the following areas:

- Zwelisha
- Moyeni
- Mkukwini
- Dukuza
- Okhombe
- Obanjani

³⁶ Personal communication: Mr Suben Ramberose, Superintendent, Okhahlamba area, uThukela DM staff (15 May 2020)

³⁷ Ascertained from UAP Phase 3 GIS data (Umgeni Water, May 2020)

Submersible pumps supply raw water from the raw water holding tank to the head of the works. These two duty submersible pumps can together provide up to 3.6 Mℓ/day (no standby pump in place). See **Table 13.41** for further details on the raw water pumps.

The Water Treatment Plant (WTP) comprises:

- Raw water settling tank (two duty submersible pumps)
- Lime dosing facility (unused)
- Coagulant dosing, with rapid mixing
- Flocculation channels
- 5 Clarifiers
- 4 Pressure filters
- Disinfection (chlorine gas)
- Treated water reservoir of 100kℓ (inadequate)
- High lift pump station to the community

See **Table 13.40** for further details on the various components of the WTP.

The Zwelisha Moyeni WTP process is summarised as follows:

“Zwelisha WW pumps raw water from the Tugela River (Khombe River). The pre-treatment process involves aluminium sulphate coagulant dosing followed by hydraulic rapid mixing to aid in coagulation. The water is flocculated in two consecutive baffled flocculation channels. The flocculated water is conveyed to five circular upflow clarifiers. The clarified water is finally conveyed to four pressure filters thereafter filtered water is post-chlorinated (or disinfected) and stored in the reservoir on-site for distribution to Okhombe and Obonjani communities.”

(Umgeni Water 2017: 2)

The uThukela District Municipality (uTDM) then distributes the potable water from the Zwelisha WTP to the Zwelisha and Moyeni communities by a system of pump stations and reservoirs to the respective communities as shown in **Figure 13.50**. In summary, treated water is pumped from the Zwelisha Moyeni WTP to the Elevated tank at Zwelisha Pump station 2 via a 250mm diameter uPVC pipeline using a KSB WKLn 80/3 pump (with a WILO pump on standby). Water is pumped up from Zwelisha Pump Station 2 to the Zwelisha Reservoir 1, which is a 2 Mℓ command reservoir, from which water is reticulated to the Zwelisha community. Zwelisha Reservoir 1 supplies water in a westerly direction to Zwelisha Reservoir 2 (500kℓ) via a 200mm diameter uPVC pipeline, which feeds down to the Kwamiya area (South). uTDM is planning to upgrade the Zwelisha Moyeni WTP in the near future.

Zwelisha Reservoir 1 also supplies water in a South Easterly direction via a 200mm diameter uPVC pipeline to Moyeni area, Zwelisha reservoir 3 and down to Dukuza. Dukuza pump station pumps water to both the Dukuza Reservoir 1 and Dukuza Reservoir 2, but this Dukuza system is inactive as water is not reaching the Dukuza pump station, due to excessive demand and water losses on the pipeline system (supply system) leading to the Dukuza pump station. This is due to the number of unauthorised connections, which are leaking. The original level of service for this scheme was standpipes, and it is struggling to sustain the unauthorised yard connection level of service. As such, the Dukuza sub system has not been officially operated by the uTDM. This is currently being resolved by the uTDM project management unit, by preparing to construct a package plant on the Mnweni river (nearby) and to then pump the treated water up to the existing Dukuza pump station³⁸. The details of all the pump stations, reservoirs, and pipelines are tabled in **Table 13.41**, **Table 13.42**, **Table 13.43** and **Table 13.44**.

³⁸ Personal Communication, Mr Philane Zwane, PMU Manager, uTDM (June 2020)

Table 13.40 Characteristics of the Zwelisha Moyeni WTP

| | |
|---|---|
| WTP Name: | Zwelisha Moyeni WTP |
| System: | Upper uThukela System (Khombe River, tributary of uThukela River) |
| Maximum Design Capacity: | 5 Mℓ/day - Blue Drop (Actually 2.4Mℓ/day, as the new package plant was never used – not commissioned) |
| Current Utilisation (April 2020): | 3Mℓ/day* |
| Raw Water Source | Khombe River, tributary of uThukela River |
| Raw Water Storage Capacity: | 150kℓ (raw water settling tank) |
| Raw Water Supply Capacity: | Rated at 3.6Mℓ/day* |
| Pre-Oxidation Type: | None |
| Primary Water Pre-Treatment Chemical: | Lime dosing facility is available within the plant, used when necessary |
| Coagulant | Aluminium Sulphate used in the past |
| Total Coagulant Dosing Capacity: | Duty Dosing Pump Capacity = 17 ℓ/hr Standby Dosing Pump Capacity = 17 ℓ/hr (non-operational) |
| Rapid Mixing Method: | At the weir of the holding tank – downstream of the raw water buffer tank (sufficient mixing energy) |
| Slow Mixing Method : | Flocculation channels |
| Clarifier Type: | Dortmund clarifier, upflow. |
| Number of Clarifiers: | 5 |
| Total Area of all Clarifiers: | 277.9 m ² (55.88m ² each) |
| Total Capacity of Clarifiers: | For a design upflow rate of 1m/hr, clarifiers are able to treat a capacity of 6.7Mℓ/day. |
| Filter Type: | Pressure Filters |
| Number of Filters: | 4 (a further 4 exist, but are old & abandoned/unused) |
| Total Filtration Area of all Filters | 20.4 m ² (5.1 m ² each) |
| Total Filtration Design Capacity of all Filters: | Filtration rate of 10m/hr = 5Mℓ/day |
| Total Capacity of Backwash Water Tanks: | 0kℓ (No Backwash Recovery) |
| Total Capacity of Sludge Treatment Plant: | 50kℓ The capacity of the two large reed beds are unknown |
| Capacity of Used Wash water System: | 0kℓ/d (No Backwash Recovery) |
| Primary Post Disinfection Type: | Chlorine gas; 70kg cylinders |
| Disinfection Dosing Capacity: | 1 kg/hr Chlorinator (the usual dosing rate is 350g/hr*) |
| Disinfectant Storage Capacity: | 8 x 70kg cylinders (currently 4) |
| Total Treated Water Storage Capacity: | 1 Reservoir, is 100kℓ capacity (in WTP premises) |

*Personal communication: Mr Suben Ramberose, Superintendent, Okhahlamba area, uThukela DM staff (15 May 2020)

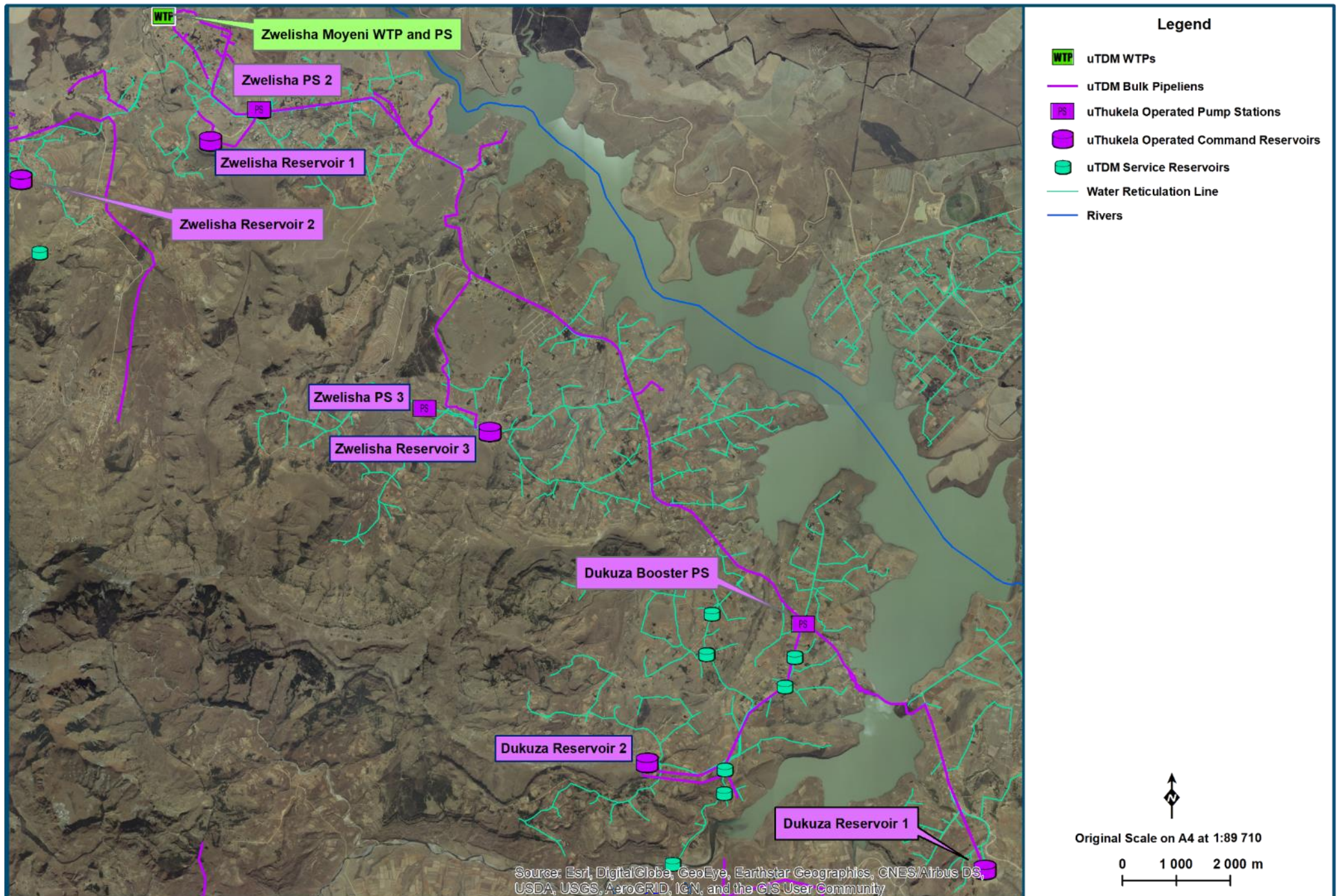

Figure 13.49 Zwelisha Moyeni WTP Supply System Layout NGI 2014; Umgeni Water 2020)

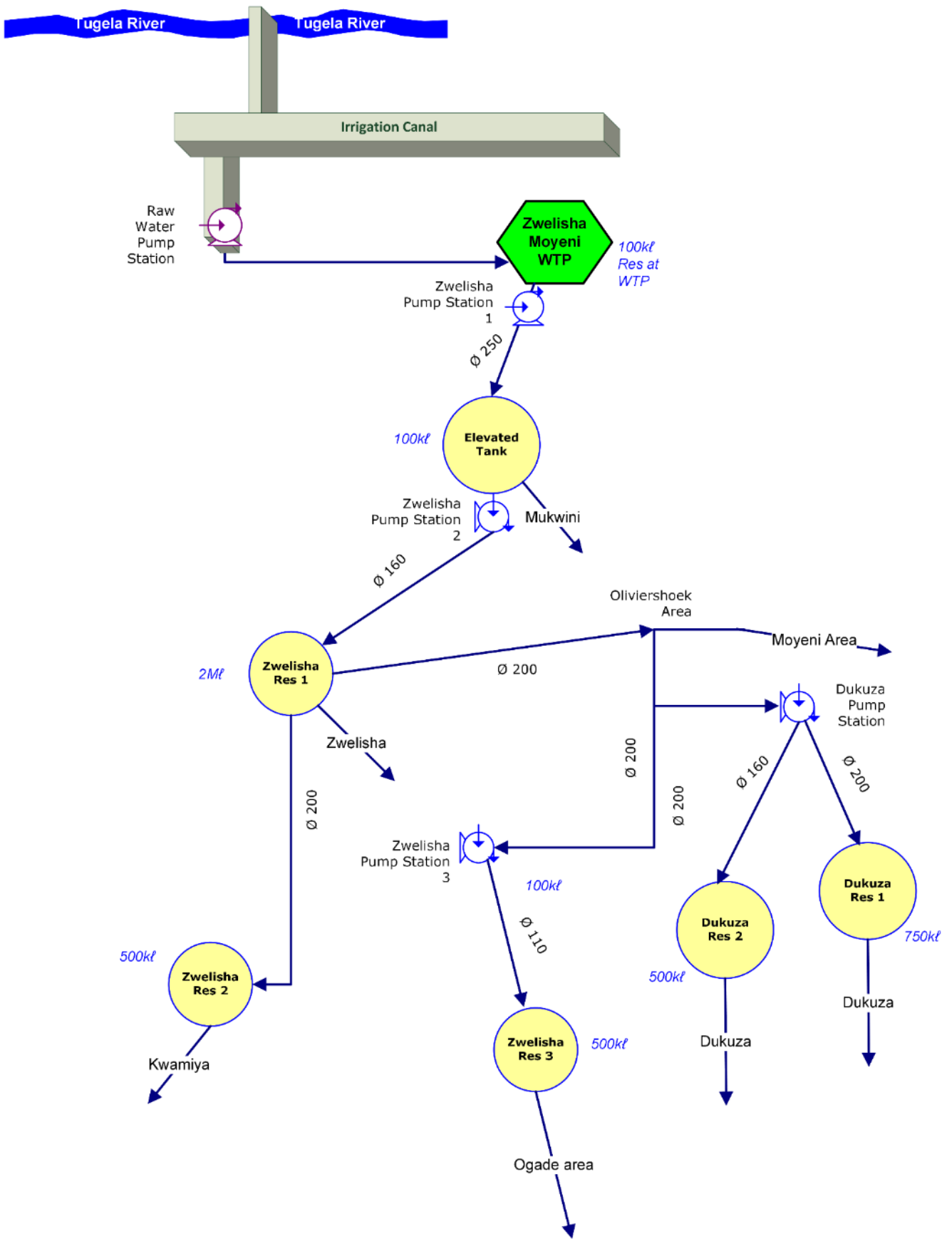

Figure 13.50 Zwelisha Moyeni WTP Supply System Schematic (not to scale; uTDM Infrastructure)

Table 13.41 Zwelisha Moyeni Raw Water Pump Stations

| System | Pump Station Name | Number of Pumps | | Pump Description | Supply From | Supply To | Static Head (m) | Duty Head (m) | Duty Capacity for duty pumps (Mℓ/day) |
|-----------------|---|----------------------|-------------------------|-----------------------|--|---------------------|-----------------|---------------|---------------------------------------|
| | | Number of Duty Pumps | Number of Standby Pumps | | | | | | |
| Zwelisha Moyeni | Zwelisha Moyeni raw water (Submersible pumps) | 2 | 0 | ? (Submersible pumps) | Raw water holding tank; Channel off the Khombe River | Zwelisha Moyeni WTP | 4 | 8.5 | 3.6 |

Table 13.42 Pump details: Zwelisha Moyeni Clear Water Pump Station (high lift)

| System | Pump Station Name | Number of Pumps | | Pump Description | Supply From | Supply To | Static Head (m) | Duty Head (m) | Duty Capacity (Mℓ/day) |
|-----------------|--|----------------------|-------------------------|---------------------------------------|---|---|-----------------|-------------------------|-------------------------|
| | | Number of Duty Pumps | Number of Standby Pumps | | | | | | |
| Zwelisha Moyeni | Zwelisha/Moyeni Clear water pump station | 1 | | KSB WKLn 80/3 (not on site 2019/2020) | Zwelisha Moyeni WTP: Pump station | Zwelisha Booster Pump Station 2 (elevated tank) | 85.1* | Unknown, in for repairs | Unknown, in for repairs |
| | | | 1 | WILO MVI9505 - 3/25/E/3-400-50-2 | Zwelisha Moyeni WTP: Pump station | Zwelisha Booster Pump Station 2 (elevated tank) | 85.1* | No info on pump plate | No info on pump plate |
| | Zwelisha Booster Pump Station 2 | | 1 | KSB WKLn 50/5 | Zwelisha Booster Pump Station 2 | Zwelisha Res 1 (which feeds Zwelisha Res 2) | 138.8* | No info on pump plate | No info on pump plate |
| | | 1 | | Howden HMW 50-5 | Zwelisha Booster Pump Station 2 | Zwelisha Res 1 (which feeds Zwelisha Res 2) | 138.8* | No info on pump plate | No info on pump plate |
| | Dukuza Booster Pump Station | 1 | 1 | **Mono (model unknown to uTDM) | Dukuza Booster Pump Station | Dukuza Res 1 | 90* | ** | ** |
| | Dukuza Booster Pump Station | 1 | 1 | Mono (model unknown to uTDM) | Dukuza Booster Pump Station | Dukuza Res 2 | 215* | ** | ** |
| | Zwelisha Booster Pump Station 3 | 1 | 1 | KSB WKLn 50/4 | Zwelisha Booster Pump Station 3 (Ogade) | Zwelisha Res 3 | ? | No info on pump plate | No info on pump plate |

*Ascertained from UAP Phase 3 GIS data (Umgeni Water, May 2020)

**Pump station could not be accessed (not taken over by uTDM)

Table 13.43 Zwelisha Reservoir details: Clear water system Reservoirs

| System | Reservoir Site | Reservoir Name | *Capacity (kℓ) | Function | *TWL (mASL) | **FL (mASL) |
|-----------------|---------------------|----------------|----------------|-------------------|-------------|-------------|
| Zwelisha Moyeni | Zwelisha Moyeni WTP | WTP Reservoir | 100 | Command reservoir | 1220.5 | 1218.5 |
| | Zwelisha Res 1 | Zwelisha Res 1 | 2000 | Command reservoir | 1448.4 | 1442.4 |
| | Zwelisha Res 2 | Zwelisha Res 2 | 500 | Service reservoir | 1406.7 | 1402.7 |
| | Dukuza Res 1 | Dukuza Res 1 | 750 | Service reservoir | 1309.3 | 1305.3 |
| | Dukuza Res 2 | Dukuza Res 2 | 500 | Service reservoir | 1434.2 | 1430.2 |
| | Zwelisha Res 3 | Zwelisha Res 3 | 500 | Service reservoir | 1368.8 | 1364.8 |

**Ascertained from UAP Phase 3 GIS data (Umgeni Water, May 2020)

*Exact dimensions and to be confirmed on site

Table 13.44 Zwelisha Pipeline details: Clear water bulk Pipeline (rising mains to command reservoirs)

| System | Pipeline Name | From | To | **Length (km) | Nominal Diameter (mm) | *Material and class | ***Capacity (Mℓ/day) | *Age (years) |
|-----------------|---|--|---|---------------|-----------------------|---------------------|----------------------|--------------|
| Zwelisha Moyeni | Zwelisha Moyeni Rising Main to Booster Pump Station | Zwelisha Moyeni WTP: Pump station | Zwelisha Booster Pump Station 2 | 3.7 | 250* | UPVC CL16 | 4.9 | 15 |
| | Rising Main to Zwelisha Res 1 | Zwelisha Booster Pump Station 2 | Zwelisha Res 1 (which feeds Zwelisha Res 2) | 1.5 | 160** | UPVC CL16 | 1.9 | 15 |
| | Gravity Main to Dukuza Booster Pump Station | Zwelisha Res 1 | Dukuza Booster Pump Station | 17 | 200** | UPVC CL16 | 2.77 | 15 |
| | Gravity Main to Zwelisha Booster Pump Station 3 | Zwelisha Res 1 (from tee junction off gravity main in row above) | Zwelisha Booster Pump Station 3 | 2.9 | 200** | UPVC CL16 | 2.77 | 15 |
| | Rising Main to Dukuza Res 1 | Dukuza Booster Pump Station | Dukuza Res 1 | 6.5 | 200** | UPVC CL16 | 2.77 | 15 |
| | Rising Main to Dukuza Res 2 | Dukuza Booster Pump Station | Dukuza Res 2 | 4.7 | 160* | UPVC CL16 | 1.9 | 15 |
| | Rising Main to Zwelisha Res 3 | Zwelisha Booster Pump Station 3 | Zwelisha Res 3 | 1 | 110* | UPVC CL16 | 0.9 | 15 |
| | Gravity main to Res 2 | Zwelisha Res 1 | Zwelisha Res 2 | 6 | 200* | UPVC CL16 | 2.77 | 15 |

*Personal communication with Mr Sizwe Khubeka (informed estimate), uTDM Staff (May 2020)

**Ascertained from UAP Phase 3 GIS data (Umgeni Water, May 2020)

***Estimate, based on nominal velocity of 1.5 m/s.

(f) Bergville WTP and Supply Scheme

The Bergville WTP was built in 1998 to supply water to the Bergville Water Supply Scheme. The design capacity is 4 ML/day (Blue drop), however the plant has been producing 3.2ML/day³⁹ for the last 6 months. 3.5 ML/day is abstracted from the Tugela River. The actual abstraction point is from a small weir in the Tugela River, downstream of Woodstock Dam and Driel Barrage. Water meter records are poor due to non-functional water meters. The WTW is just above the settlements of Bergville and is within the Inkosi Langalibalele Local Municipality.

The co-ordinates of the WTP are as follows:

Latitude (South) - 28°44'01" Longitude (East) 29°20'59"⁴⁰



Figure 13.51 Bergville WTP (Bigen Africa, O & M Manual Bergville, 2009)

The Bergville WTP supplies water to the following areas:

- Bergville
- Hambrook
- Rooihoek
- Malottas Kraal
- Bethani (1 & 2)
- Woodford
- Rookdale

³⁹ Personal communication, Mr Suben Ramberose, Superintendent, Okhahlamba area, uThukela DM staff (15 May 2020)

⁴⁰ Ascertained from UAP Phase 3 GIS data (Umgeni Water, May 2020)

Abstraction from the Tugela River is via 2 duty Gorman Rupp T6 pumps and the 200mm diameter uPVC raw water rising main that conveys to the head of the works. These two duty pumps together provide 5.76 Mℓ/d. See **Table 13.46** for further details on the raw water pumps. A standby pump is in place and functional.

The Bergville WTP comprises:

- Raw water holding tank
- Coagulant dosing, with rapid mixing via hydraulic jump (weir)
- Flocculation channels
- 2 Clarifiers
- 2 Autonomous valveless gravity filters
- Disinfection (chlorine gas)
- Treated water reservoir of 1000kℓ
- High lift pump station to the community

See **Table 13.45** for further details on the various components of the WTP.

The Bergville WTP process is summarised as follows:

“Raw water is abstracted from the Thukela River and is pumped via three pumps to a raw water holding tank which has 3 channels. A polymeric coagulant is dosed over a weir, before a baffled hydraulic jump for rapid mixing. Slow mixing is achieved by a flocculation channel before the flow splits into two circular upflow clarifiers. The clarified water is disinfected inline and then flows into two autonomous valveless gravity filters (AVGF).”

(Umgeni Water 2017: 6)

Treated water is pumped from the clear water pump station at the Bergville WTP, up to the Command reservoir (4Mℓ storage) via a 200mm diameter uPVC pipeline, using KSB ETA pumps. The high lift pump station at this Command reservoir is referred to as the Caltex pump station. There is a 250mm diameter rising main from the Caltex pump station that runs up to the Woodford and Bethany Command reservoirs. At the Woodford reservoir, there is pump station to boost water up to the Rookdale reservoir via a 160mm diameter rising main. Note that Bergville (town) is also supplied directly from the Command reservoir at the Caltex pump station. There is a rising main from the Command reservoir to the areas of Acton Holmes and Hambrook, which have their own service reservoirs. At a junction on this rising main, the rising main tees off to the Rooihoek/Malottas Kraal (Greenpoint) areas. A further booster pump station is required to on this rising main to push water up to these reservoirs of Rooihoek/Malottas Kraal (Greenpoint). **Figure 13.53** is a supply system schematic that provides an overview of the current distribution arrangement described above. The details of the pump stations, reservoirs, and pipelines are tabled in **Table 13.46**, **Table 13.47**, **Table 13.48**, and **Table 13.49**.

The original level of service for the lower income areas (outside of Bergville town) of this scheme was standpipes, and the scheme is struggling to sustain the unauthorised yard connection level of service. The unauthorised connections in these areas result in a water demand that the Bergville Water Supply Scheme (WSS) was never designed to sustain. Due to this prevailing issue, there are areas of the Bergville WSS that receive water sporadically. The major bottleneck is the Bergville WTP, and the uTDM are currently planning the upgrade of the WTP. In the interim, the uTDM maintenance teams are trying to address the waterlosses in the reticulation system, and repair the package plant (1.5Mℓ/day) adjacent to the main WTP (the package plant has not been operational for six years).

Table 13.45 Characteristics of the Bergville WTP.

| | |
|---|---|
| WTP Name: | Bergville WTP |
| System: | Upper uThukela System (uThukela River) |
| Maximum Design Capacity: | 4 Mℓ/day (Blue Drop) (including a package plant, which is stand alone but share the source and the final water reservoir, next to the main WTP, technical details of which have been excluded in this table, as the plant has been offline for 6 years*, and details of components are not available) (2.4Mℓ/day without the package plant) |
| Current Utilisation (April 2020): | 3.2Mℓ/day* |
| Raw Water Source | Actual abstraction point is from a small weir in the uThukela River, downstream of Woodstock Dam and Driel Barrage. |
| Raw Water Storage Capacity: | None |
| Raw Water Supply Capacity: | Rated at 5Mℓ/day (each pump has a capacity of 2.88Mℓ/day – 2 duty, 1 standby. 1 Pump for main plant; 1 Pump for package plant) |
| Pre-Oxidation Type: | None |
| Primary Water Pre-Treatment Chemical: | None |
| Coagulant | Sudloc 3870 (polymeric coagulant) |
| Total Coagulant Dosing Capacity: | Duty Dosing Pump Capacity = 29.96 ℓ/hr (currently set at 40%)* Standby Dosing Pump Capacity = 29.96 ℓ/hr |
| Rapid Mixing Method: | At the flocculation hydraulic jump – downstream of the raw water buffer tank (sufficient mixing energy, due to baffles) |
| Slow Mixing Method : | Flocculation channels |
| Clarifier Type: | Circular clarifier, upflow. Concrete. |
| Number of Clarifiers: | 2 |
| Total Area of all Clarifiers: | 86 m ² (43m ² each) |
| Total Capacity of Clarifiers: | For a design upflow rate of 1.38m/hr, clarifiers are able to treat a capacity of 2.85Mℓ/day. |
| Filter Type: | Pressure Filters |
| Number of Filters: | 2 |
| Total Filtration Area of all Filters | 36.54 m ² (18.27 m ² each) |
| Total Filtration Design Capacity of all Filters: | Filtration rate of 6.5m/hr = 5.4 Mℓ/day |
| Total Capacity of Backwash Water Tanks: | 0kℓ (No Backwash Recovery) |
| Total Capacity of Sludge Treatment Plant: | 400kℓ (two sludge drying beds) |
| Capacity of Used Wash water System: | 0kℓ/d (No Backwash Recovery) |
| Primary Post Disinfection Type: | Chlorine gas; 70kg cylinders |
| Disinfection Dosing Capacity: | 1kg/hr Chlorinator (the usual dosing rate is 400g/hr*) |
| Disinfectant Storage Capacity: | 5 x 70kg cylinders |
| Total Treated Water Storage Capacity: | 1 Reservoir, is 1000kℓ capacity (in WTP premises) |

*Personal communication: Mr Suben Ramberose, Superintendent, Okhahlamba area, uThukela DM staff (15 May 2020)

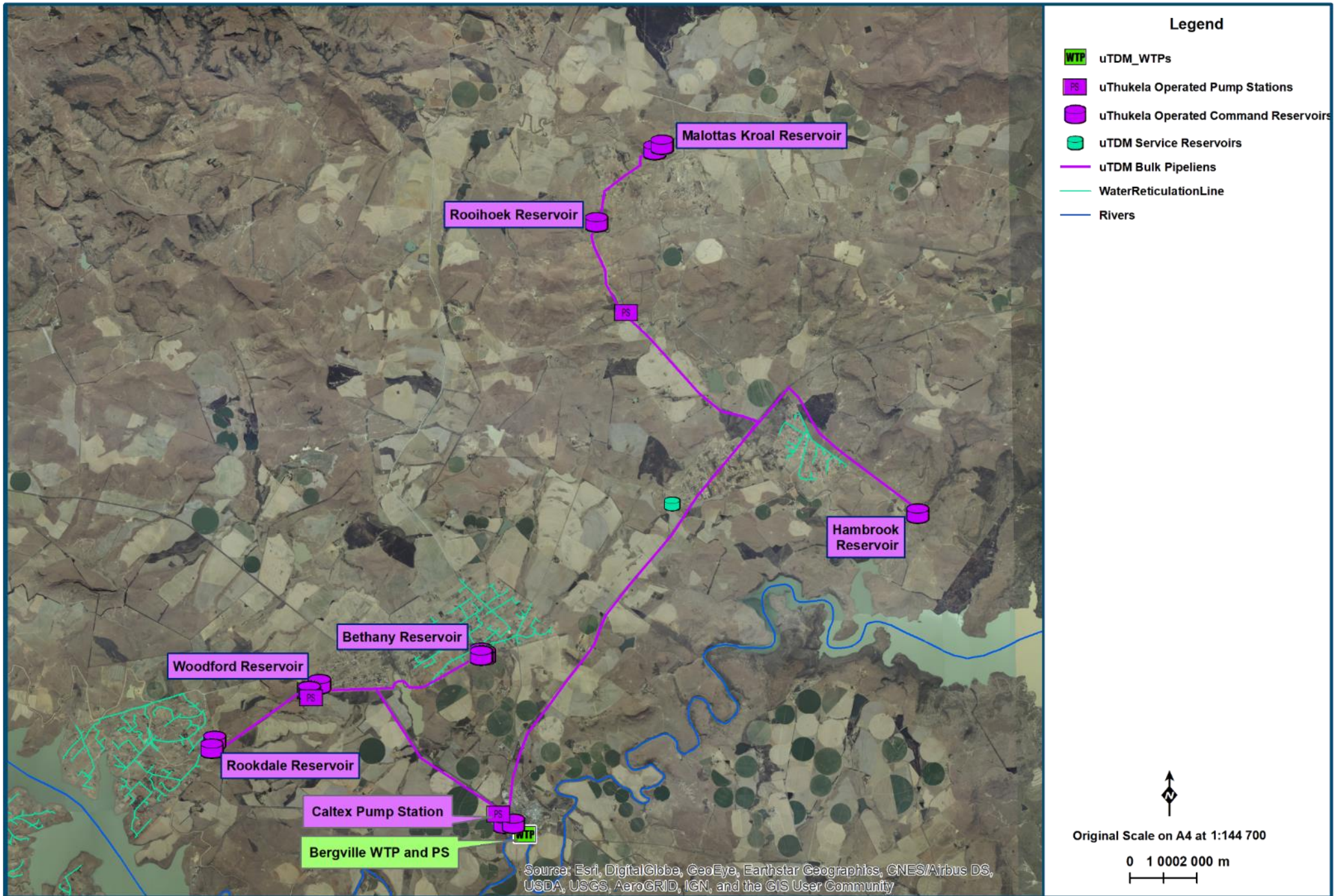

Figure 13.52 Bergville WTP Supply System Layout (NGI 2014; Umgeni Water 2020)

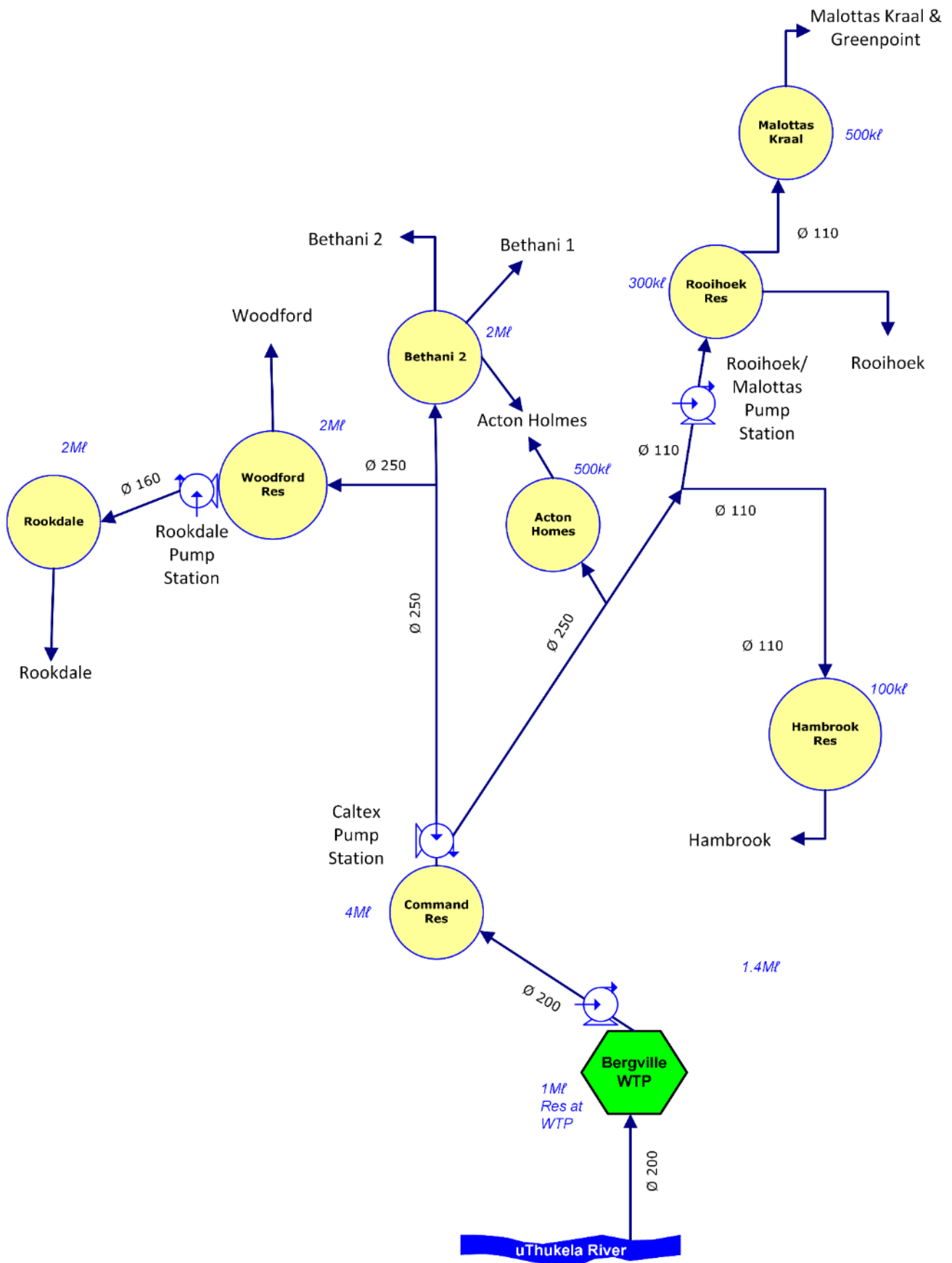

Figure 13.53 Bergville WTP Supply System Schematic (not to scale; uTDM Infrastructure)

Table 13.46 Pump details: Bergville Raw Water Pump Stations

| System | Pump Station Name | Number of Pumps | | Pump Description | Supply From | Supply To | Static Head (m) | Duty Head (m) | Duty Capacity for duty pumps (Ml/day) |
|------------------------|------------------------|----------------------|-------------------------|------------------------|--------------------------------|---------------|-----------------|---------------|---------------------------------------|
| | | Number of Duty Pumps | Number of Standby Pumps | | | | | | |
| Bergville Bergville | Raw water pump station | 2 | | Gorman Rupp T6 A3-B/FM | Tugela river abstraction point | Bergville WTP | 3.5 | 19.7 | 2.88 (per pump) |
| | | | 1 | Gorman Rupp T6 A3-B/FM | Tugela river abstraction point | Bergville WTP | 3.5 | 19.7 | 2.88 |

Table 13.47 Pump details: Bergville Clear Water Pump Stations

| System | Pump Station Name | Number of Pumps | | Pump Description | Supply From | Supply To | Static Head (m) | Duty Head (m) | Duty Capacity (Ml/day) |
|-----------|--|----------------------|------------------------------|----------------------------|--|---|-----------------|---------------------------------|--------------------------------|
| | | Number of Duty Pumps | Number of Standby Pumps | | | | | | |
| Bergville | Clear water pump station WTP (high lift) | 1 | 1 | KSB ETA NORM 100-080-250 | WTP Clear water pump station | Bergville Town Command Reservoirs | 41 | 68.5** No info on pump plate | 4.5** No info on pump plate |
| | Caltex Bergville Pump Station | 1 | 1 | KSB WKLn 80/3 | Caltex Bergville Pump Station at Bergville Town Command Reservoirs | Woodford and Bethany Command Reservoirs | 82.65 | 147 | 1.944 |
| | | 1 | 1 | KSB ETA BLOC 065- 40-160 | | Hambrook, Acton Homes & Rooihoek Pump station | 42 | No info on pump plate | No info on pump plate |
| | Rookdale Pump Station (at Woodford Res) | 1 | 1 (currently in for repairs) | KSB WKLn 50/4 | Rookdale Pump Station (at Woodford Res) | Rookdale Command Res | 113.55 | 111 | 0.6 |
| | Rooihoek Pump station | 1 | 1 | Grundfos MS600 T40 (9.2kW) | Rooihoek Pump station | Rooihoek & Malottas Kraal Distribution Reservoirs | 101 | No info on pump plate | No info on pump plate |
| | | | | | | | | | |

**Plant O&M Manual

Table 13.48 Reservoir details: Clear water system Reservoirs

| System | Reservoir Site | Reservoir Name | *Capacity (Mℓ) | Function | **TWL (mASL) | ***FL (mASL) |
|-----------|---------------------------------------|---------------------------------------|----------------|-------------------|--------------|--------------|
| Bergville | Bergville WTP | Bergville WTP | 1 | Command reservoir | 1121.4 | 1118.4 |
| | Bergville Town Command reservoirs | Bergville Town Command reservoirs | 4 | Command reservoir | 1161.8 | 1158.8 |
| | Woodford Command Reservoir | Woodford Command Reservoir | 2 | Command reservoir | 1245.5 | 1241.5 |
| | Bethany Command Reservoir | Bethany Command Reservoir | 2 | Command reservoir | 1235.5 | 1231.5 |
| | Rookdale Command Res | Rookdale Command Res | 2 | Command reservoir | 1359.5 | 1355.5 |
| | Hambrook Res | Hambrook Res | 0.1 | Service reservoir | 1144.2 | 1142.2 |
| | Acton Homes Res | Acton Homes Res | 0.5 | Service reservoir | 1143.6 | 1140.6 |
| | Rooihoek Distribution Reservoir | Rooihoek Distribution Reservoir | 0.3 | Service reservoir | 1244.5 | 1242 |
| | Malottas Kraal Distribution Reservoir | Malottas Kraal Distribution Reservoir | 0.5 | Service reservoir | 1218.4 | 1215.4 |

*Personal communication with Mr Moses Sibeko (informed estimate), UW Staff (May 2020) (ex-uTDM staff). To be confirmed on site.

**Reservoir height is an informed estimate provided by Mr Moses Sibeko (informed estimate), UW Staff (May 2020) (ex-uTDM staff)

*** Levels obtained from ARCGIS (UAP Phase 3, Umgeni Water, May 2020)

Table 13.49 Bergville Pipeline details: Bulk Pipelines

| System | Pipeline Name | From | To | Length* (km) | **Nominal Diameter (mm) | **Material | Capacity (Mℓ/day) | Age (years) |
|-----------|---------------------------------------|---|---|-----------------|---|------------|-----------------------------------|----------------|
| Bergville | Raw water rising main | Tugela river abstraction point | Bergville WTP | 0.5 | 200 | uPVC cl12 | 2.77 | 22 |
| | Rising Main to Bergville Town Command | WTP Clear water pump station | Bergville Town Command reservoirs | 0.9 | 200 | uPVC cl12 | 2.77 | 22 |
| | Woodford and Bethany Rising Main | Pump Station at Bergville Town Command reservoirs | Woodford and Bethany Command Reservoirs | 11 | 250 | uPVC cl12 | 4.9 | 11 |
| | Rookdale Rising Main | Rookdale Pump Station (at Woodford Res) | Rookdale Command Res | 3.5 | 160 | uPVC cl16 | 1.9 | 22 |
| | Rising Main to Rooihoek Pump Station | Pump Station at Bergville Town Command reservoirs | Rooihoek Pump station (and Hambrook Res) | 26.6 | 250 (then to 110s at junctions to Rooihoek PS & Hambrook) | uPVC cl16 | 4.9 (0.9 for the 110mm dia pipes) | 11 |
| | Rooihoek Rising Main | Rooihoek Pump station | Rooihoek & Malottas Kraal Distribution Reservoirs | 2.5 | 160 | uPVC cl12 | 2.1 | 11 |
| | Malottas Kraal Gravity main | Rooihoek Res | Malottas Kraal Res | 3.3 | 110 | uPVC cl9 | 0.9 | 11 |

*Pipelines length obtained from ARCGIS (UAP Phase 3, Umgeni Water, May 2020)

**Personal communication with Mr Moses Sibeko (informed estimate), UW Staff (May 2020) (ex-uTDM staff); as well as Mr Sizwe Khubeka, uTDM staff (May 2020)

(g) Colenso Water Treatment Plant and Supply System

The Colenso WTP was built in 1977 to supply water to the Colenso Water Supply Scheme. The design capacity is 2.64 Mℓ/day (Blue drop and O&M Manual) however; the plant has been producing 2.85Mℓ/day⁴¹ for the last 6 months (3 Mℓ/day is abstracted daily from the uThukela River). Water meter records are poor due to non-functional water meters. The WTW is in the town of Colenso, next to the highway, and is just within the Alfred Duma Local Municipality.

The co-ordinates are as follows:

Latitude (South) 28° 43' 60" Longitude (East) 29°49' 21"⁴²



Figure 13.54 Colenso WTP (Umgeni Water 2017)

The Colenso WTP supplies water to the following areas:

- Colenso town
- Inkanyezi
- Roosboom
- Berea

⁴¹ Personal communication, Mr Abre Nel, Superintendent for Alfred Duma LM, uThukela DM staff (13 May 2020)

⁴² Ascertained from UAP Phase 3 GIS data (Umgeni Water, May 2020)

Abstraction from the Tugela River is via three duty Tsurumi Pumps pumps and the 150mm diameter Klambon raw water rising main that conveys to the head of the works. These three duty pumps together provide 3 Mℓ/d. See **Table 13.51** for further details on the raw water pumps. There is no standby pump in place.

The Colenso WTP comprises:

- Raw water holding tank
- Coagulant dosing, with rapid mixing via static in-line mixer
- Flocculation channels
- 2 Clarifiers (rectangular, Dortmund type)
- Disinfection (chlorine gas)
- 2 Pressure filters
- High lift pump station pumps to the Berea reservoirs

See **Table 13.50** for further details on the various components of the WTP.

The Colenso WTP process is summarised as follows:

“Colenso WW abstracts raw water from the Tugela River. The pre-treatment process involves in-line polymeric coagulant dosing which is rapidly mixed via a static in-line mixer. The water is flocculated in a flocculation basin and further in a baffled flocculation channel. The water undergoes clarification via two Dortmund-type rectangular clarifiers and then conveyed to two holding tanks. The clarified water from the holding tanks is chlorinated prior to being conveyed to two pressure filters. The filtered water is pumped directly to a service reservoir via two high-lift pumps for distribution to the town of Colenso. The water treatment residue generated is conveyed to two sludge holding tanks onsite.”

(Umgeni Water 2017: 4)

Treated water is pumped from the high lift pump station at the Colenso WTP up to the Berea elevated tanks via a 250mm diameter AC pipe using a Normaflow M&B pump (1 duty, 1 standby). At a junction on this rising main is a tee off to the Inkanyesi reservoir (2 Mℓ), which supplies water to the growing community of Inkanyesi. Most of the tanks at the Berea reservoir site are in a state of disrepair and are thus bypassed. Only 210 kℓ of storage is available and 750 kℓ of storage is not usable. The Berea tanks provide water to the town (CBD) of Colenso and its suburbs. A 150mm diameter AC gravity pipe runs from the Berea tank to the Roosboom tank, supplying the area of Roosboom. The Colenso WTP and distribution system are struggling to keep up with the demand. **Figure 13.56** is a supply system schematic that provides an overview of the current distribution system described above. The details of the pump stations, reservoirs, and pipelines are tabled in **Table 13.51**, **Table 13.52**, **Table 13.53**, **Table 13.54** and **Table 13.55**.

The original level of service for the Inkanyesi area of this Colenso Water Supply Scheme (WSS) was standpipes, and the scheme is struggling to sustain the unauthorised yard connection level of service, as well as supply to the new low cost housing project⁴³. The unauthorised connections and water losses in these areas result in a water demand that the Colenso WSS was never designed to sustain. Due to this prevailing issue, there are areas of the Colenso WSS that receive water sporadically (or low pressure). The major bottleneck is the Colenso WTP, and the uTDM are currently planning the upgrade of the WTP. In the interim, the uTDM maintenance teams are trying to address the water losses in the reticulation system, and conversing with the community on lowering water demand.

⁴³ Personal communication, Mr Abre Nel, Superintendent for Alfred Duma LM, uThukela DM staff (13 May 2020)

Table 13.50 Characteristics of the Colenso WTP.

| | |
|---|--|
| WTP Name: | Colenso WTP |
| System: | Upper uThukela System (Thukela River) |
| Maximum Design Capacity: | 2.64 Mℓ/day (O&M Manual) |
| Current Utilisation (April 2020): | 2.8Mℓ/day |
| Raw Water Source | Thukela River |
| Raw Water Storage Capacity: | None |
| Raw Water Supply Capacity: | Rated at 3Mℓ/day (3 raw water pumps) |
| Pre-Oxidation Type: | None |
| Primary Water Pre-Treatment Chemical: | None |
| Coagulant | Zetafloc 2365 |
| Total Coagulant Dosing Capacity: | Duty Dosing Pump Capacity = 38ℓ/hr Standby Dosing Pump Capacity: No standby pump. |
| Rapid Mixing Method: | Mixing chamber – flocculation mixing basin |
| Slow Mixing Method : | Flocculation channels |
| Clarifier Type: | Dortmund clarifier, upflow, rectangular |
| Number of Clarifiers: | 2 |
| Total Area of all Clarifiers: | 24m ² |
| Total Capacity of Clarifiers: | For a design upflow rate of 4.52m/hr, clarifiers are able to treat a capacity of 2.64Mℓ/day. |
| Filter Type: | Pressure Filters |
| Number of Filters: | 2 |
| Total Filtration Area of all Filters | 11m ² |
| Total Filtration Design Capacity of all Filters: | For a design filtration rate of 10m/hr, filters are able to treat a capacity of 2.64Mℓ/day. |
| Total Capacity of Backwash Water Tanks: | None |
| Total Capacity of Sludge Treatment Plant: | None (sludge dams failed completely) |
| Capacity of Used Wash water System: | None |
| Primary Post Disinfection Type: | Chlorine gas; 70kg cylinders? |
| Disinfection Dosing Capacity: | 3kg/hr Chlorinator (the usual dosing rate is 200g/hr) |
| Disinfectant Storage Capacity: | 2 x 70kg cylinders |
| Total Treated Water Storage Capacity: | None at the WTP. Filtrate is pumped directly to the Berea reservoirs which are of 210kℓ capacity (a further 750kℓ worth of tanks is not functional at this site) |

Note: this table has been populated using UW 2017 assessments, and information provided by Mr Abre Nel, Superintendent for Alfred Duma LM, uThukela DM staff (13 May 2020)

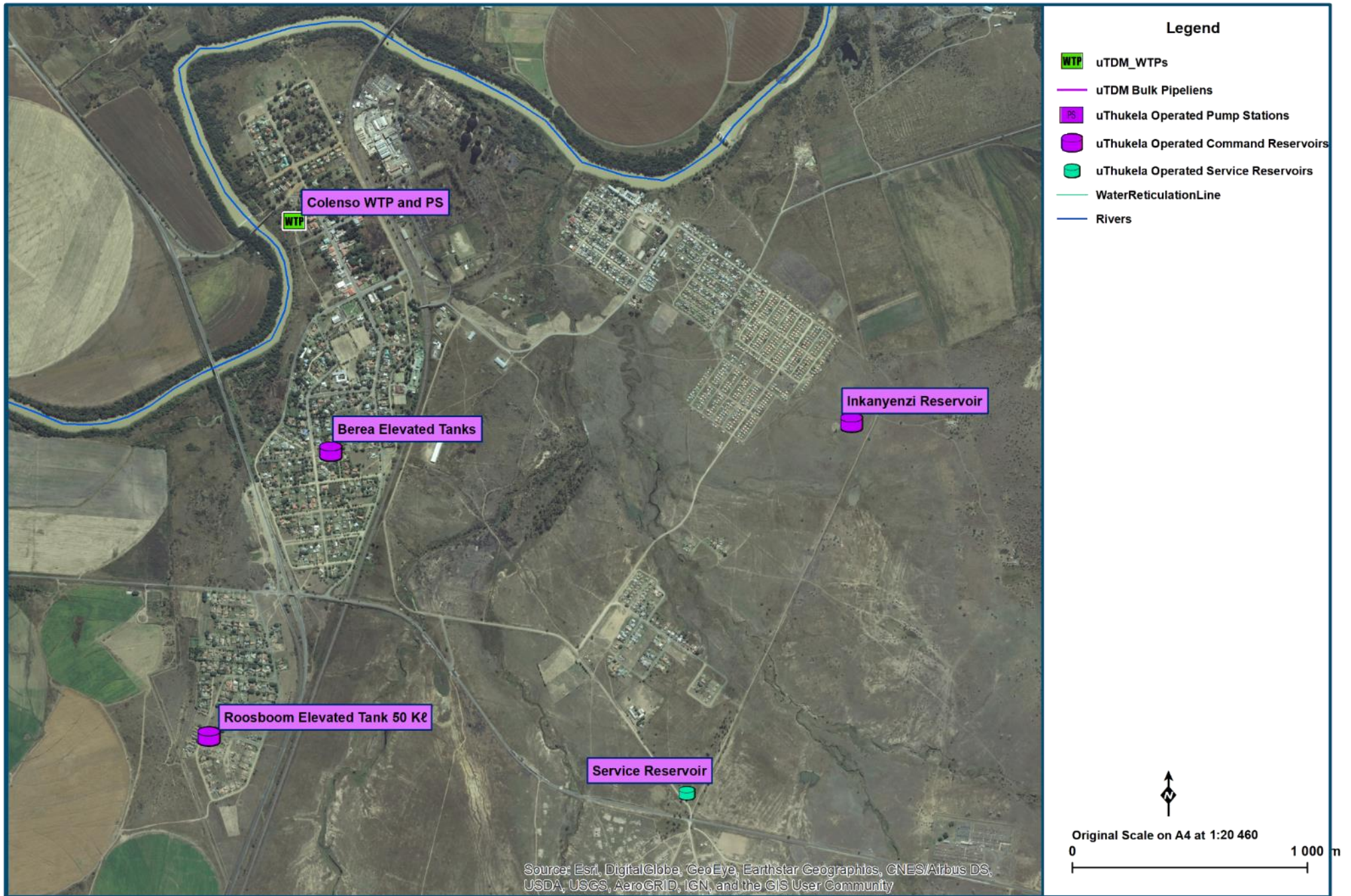

Figure 13.55 Colenso WTP Supply System Layout (NGI 2014; Umgeni Water 2020)

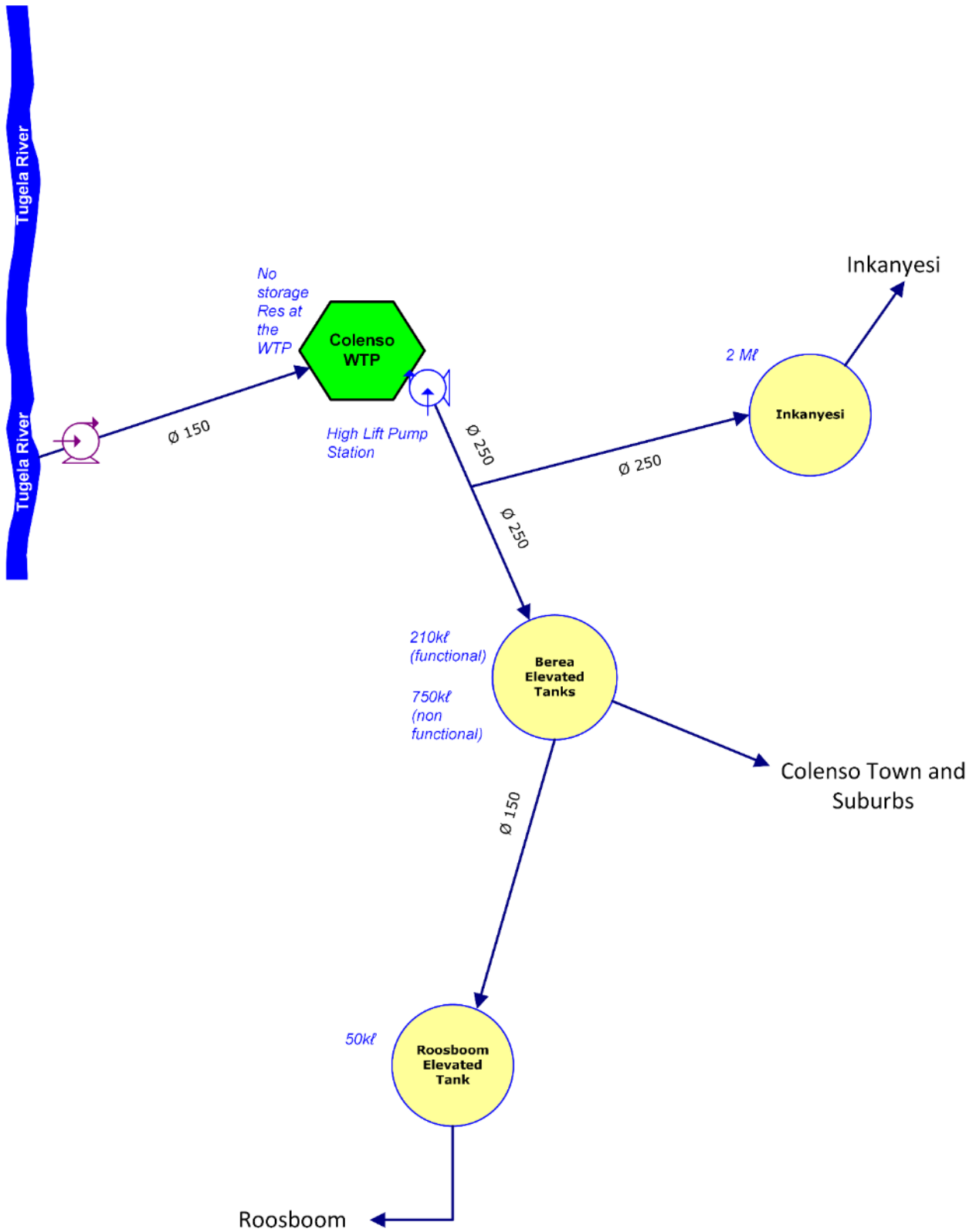

Figure 13.56 Colenso WTP Supply System Schematic (not to scale; uTDM Infrastructure)

Table 13.51 Pump details: Colenso Raw Water Pump Stations

| System | Pump Station Name | Number of Pumps | | Pump Description | Supply From | Supply To | Static Head (m) | Duty Head (m) | Duty Capacity (Mℓ/day) |
|----------------|---|----------------------|-------------------------|---|-------------------------|-------------|-----------------|---------------|---|
| | | Number of Duty Pumps | Number of Standby Pumps | | | | | | |
| Upper uThukela | Colenso raw water (Submersible pumps on trolleys) | 3 | 0** | Tsurumi Pump KTZ67.5 (Submersible pumps on trolleys) | Tugela River at Colenso | Colenso WTW | 3 | 40*** | 3* (for 3 pumps) (1.6 for one pump) (2.5 for two pumps) |

*An informed estimate provided by Mr Abre Nel, Superintendent for Alfred Duma LM, uThukela DM staff (13 May 2020)

**Due to demand, all 3 pumps run simultaneously. In effect, there is no standby

***As stated on the pump plate

Table 13.52 Pipeline details: Colenso Raw Water Rising Mains

| System | Pipeline Name | From | To | Length m | Nominal Diameter (mm) | Material | Capacity (Mℓ/day) | Age (years) |
|----------------|-------------------------------|--------------------------------|-------------|----------|-----------------------|-------------|-------------------|-------------|
| Upper uThukela | Colenso Raw Water Rising Main | Colenso Raw Water Pump Station | Colenso WTP | 100m* | 150 | GMS Klambon | 3* | 1990* |

*An informed estimate provided by Mr Abre Nel, Superintendent for Alfred Duma LM, uThukela DM staff (13 May 2020)

Table 13.53 Pump details: Colenso Clear Water Pump Station (high lift).

| System | Pump Station Name | Number of Pumps | | Pump Description | Supply From | Supply To | Static Head (m) | Duty Head (m) | Duty Capacity (Mℓ/day) |
|---------|-----------------------------------|----------------------|-------------------------|--------------------------------|--|--|-----------------|---------------------------------|-------------------------------|
| | | Number of Duty Pumps | Number of Standby Pumps | | | | | | |
| Colenso | Clear water Pump station Number 1 | 1 | 1 | Normaflo M&B Pump VE F80 20020 | Colenso WTP: Clear water Pump station Number 1 | Colenso town reservoirs (Berea Reservoirs) | 12.6 | 19** (no info on pump plate) | 3* (no info on pump plate) |

*An informed estimate provided by Mr Abre Nel, Superintendent for Alfred Duma LM, uThukela DM staff (13 May 2020)

**Estimate using calculation based on the duty capacity

Table 13.54 Reservoir details: Clear water system Reservoirs

| System | Reservoir Site | Reservoir Name | Capacity (Mℓ) | Function | *TWL (mASL) | FL (mASL) |
|---------|----------------|-------------------------------|------------------------|-------------------|-------------|-----------|
| Colenso | Berea/Town | Berea/Town Res 1 | Out of service (300kl) | Command/Service | 974.6 | 972.6 |
| | | Berea/Town Res 2 | Out of service (300kl) | Command/Service | 974.6 | 972.6 |
| | | Berea New Town Tower | Out of service (150kl) | Command/Service | 986.2 | 982.6 |
| | | Suite of Elevated steel tanks | 3 x 70kl* each | Command/Service | 986.2 | 982.6 |
| | Inkanyezi | Inkanyezi Res | 2 ML | Service reservoir | 982.8 | 980.3 |
| | Roosboom | Roosboom Elevated Tank | 50kl | Service reservoir | 997.6 | 985.6 |

*Reservoir height is an informed estimate provided by Mr Abre Nel, Superintendent for Alfred Duma LM, uThukela DM staff (13 May 2020)

Table 13.55 Pipeline details: Clear water bulk Pipeline (rising mains to command reservoirs)

| System | Pipeline Name | From | To | Length (km) | Nominal Diameter (mm) | Material | **Capacity (Mℓ/day) | Age (years) |
|---------|--|---|---|-------------|-----------------------|----------|---------------------|-------------|
| Colenso | Rising main from WTP (Inkayesi & Berea Tees) | Colenso WTP | Junction on rising main (Inkayesi & Berea Tees) | 0.77* | 250 | AC | 6.4 | 45 |
| | Rising main, from junction to Berea tanks | Junction on rising main (Inkayesi & Berea Tees) | Berea tanks | 1.1* | 250 | AC | 6.4 | 45 |
| | Rising main, from junction to Inkayesi | Junction on rising main (Inkayesi & Berea Tees) | Inkayesi Res | 2.23* | 250 | AC | 6.4 | 45 |

*Measured estimates on GIS.

**Estimate, based on nominal velocity of 1.5 m/s.

(h) Ladysmith Water Treatment Plant and Supply System

The Ladysmith WTP was built in 1978 to supply water to the Ladysmith Water Supply Scheme. The design capacity is 23 Mℓ/day, however the plant has been producing 27.5Mℓ/day⁴⁴ for the last six months. 18 Mℓ/day is abstracted from Spioenkop Dam and 12 Mℓ/day is abstracted from the Klip River. In Winter, the supply from Klip River reduces dramatically and the Ladysmith area will then require greater supply from the Ezakheni WTP. Water meter records are poor for final water due to non-functional final water meters, but the records for raw water are good. The WTP is located in the suburbs of the town of Ladysmith and is within the Emnambithi Local Municipality.

The co-ordinates are:

Latitude (South) 28°34'07"

Longitude (East) 29°46' 34"⁴⁵



Figure 13.57 Ladysmith WTP (Bigen Africa, O & M Manual Ladysmith, 2009)

The Ladysmith WTP supplies water to the following areas:

- Ladysmith CBD
- Ladysmith suburbs
- Maidens Castle (when required, normally fed by Ezakheni WTP)
- St Chads (when required, normally fed by Ezakheni WTP)
- Modderspruit (when required, normally fed by Ezakheni WTP)
- Graythrone (when required, normally fed by Ezakheni WTP)
- Parts of Ezakheni (when required, normally fed by Ezakheni WTP)
- AcaciaVille

⁴⁴ Personal communication, Mr Abre Nel, Superintendent for Alfred Duma LM, uThukela DM staff (13 May 2020)

⁴⁵ Ascertained from UAP Phase 3 GIS data (Umgeni Water, May 2020)

Abstraction from the Klip River is via 2 duty KSB KWP 150-315 pumps and the 350mm diameter steel raw water rising main that conveys to the head of the works. A further 3 KSB ETA 125-315 pumps are available but cannot be used due to technical design issues of the pump station i.e. the constant build up of sludge in the inlet/suction that is very difficult to remove. These two duty pumps together provide 15.3 Mℓ/day. Water abstracted from the Spioenkop dam is pumped to the raw water balancing reservoir (1 Mℓ) 8km away via a 510mm diameter steel pipe using 2 duty Mather Platt pumps and 1 booster pump (also Mather Platt). There is a functional standby available for each of these pumps. A 32km raw water gravity main that is of 510mm diameter (steel) transfers the raw water to the Ladysmith WTP. Under normal conditions, the volume of incoming raw water to the Ladysmith WTP is 30.62 Mℓ/day, as the plant is having to produce 27.5 Mℓ/day in order to keep up with the rising demand. This is far in excess of the rated design capacity of 23 Mℓ/day, and can be attributed to the water losses in the reticulation. The uTDM maintain that water quality is still good and acceptable (Class 1 SANS 241), even though the plant is constantly operating in excess of its design capacity. See **Table 13.57** for further details on the raw water pumps.

The Ladysmith WTP comprises:

- Coagulant dosing, with rapid mixing via hydraulic jump (weir) at mixing chamber
- Flocculation channels
- 4 Clarifiers
- 12 Rapid gravity sand filters
- Disinfection (chlorine gas)
- Treated water reservoirs of 7.7 Mℓ
- High lift pump station to the community

See **Table 13.56** for further details on the various components of the WTP.

The WTP process is summarised as follows:

“The capacity of Ladysmith WW is 23Mℓ/d. Raw water is abstracted from both Spioenkop Dam and Klip River. The raw water is coagulated using Aluminium sulphate and polymeric coagulant. There is a flocculation channel for slow mixing, before splitting into four upflow circular clarifiers. There are 12 rapid gravity sand filters, and the combined filtrate is disinfected with chlorine gas before the final water is stored in 2 on-site reservoirs.”

(Umgeni Water 2017: 2)

Treated water is pumped from the high lift pump station at the Ladysmith WTP to the Golf course reservoirs, which have a total storage capacity of 16Mℓ. There are 4 pump sets available (2 KSBs and 2 Mather Platts) for pumping up to the Golf course reservoirs, with normal conditions requiring 2 pumps running simultaneously. The rising main is a 300mm diameter AC pipe. The Golf course reservoirs feed the lower zone of Ladysmith town and suburbs. At the Golf course reservoirs, there is a high lift pump station that conveys water to the Observation Hill reservoir (8 Mℓ). These Mather Platt pumps convey 14.7 Mℓ/day to the Observation Hill reservoir, which feed the higher zone of Ladysmith town and suburbs. This rising main to Observation Hill reservoir 450mm and then a 350mm diameter steel pipe, as it reduces midway. At the Observation Hill reservoir is a 70kℓ tower reservoir, with a booster pump station, in order to feed the highest areas of Ladysmith.

Figure 13.59 is a supply system schematic that provides an overview of the current distribution system described above.

The details of the pump stations, reservoirs, and pipelines are tabled in **Table 13.57, Table 13.58, Table 13.59, Table 13.60** and **Table 13.61**.

The production rate of the WTP has been exceeding the design capacity for many years, and the Ladysmith area would need to be supplied from the uThukela Regional Water Scheme in the near future (new larger WTP near Ezakheni WTP). In the interim, this challenge is currently mitigated by the Ezakheni WTP supplying large areas of Ladysmith .e.g. Maidens Castle, St Chads, Modderspruit, Graythron and Ezakheni.

The real water losses in Ladysmith is estimated to be fairly low, as leaks are attended to quickly, but there could be numerous unknown leaks that do not surface at ground level due to the town AC pipework that was installed in 1958.

Table 13.56 Characteristics of the Ladysmith WTP.

| | |
|---|---|
| WTP Name: | Ladysmith WTP |
| System: | Upper uThukela System (Spioenkop Dam and Klip River) |
| Maximum Design Capacity: | 23 Mℓ/day |
| Current Utilisation (April 2020): | 27.5 Mℓ/day |
| Raw Water Source | Spioenkop Dam and Klip River |
| Raw Water Storage Capacity: | 0 Mℓ |
| Raw Water Supply Capacity: | Rated at 30.62Mℓ/day (from Spioenkop Dam and from Klip River) |
| Pre-Oxidation Type: | None |
| Primary Water Pre-Treatment Chemical: | Aluminium Sulphate (in Summer) |
| Coagulant | Zetafloc 2365 (Al/Polyamine) |
| Total Coagulant Dosing Capacity: | Duty Dosing Pump Capacity = 23ℓ/hr 2 x Standby Dosing Pump Capacity = 1 is 70ℓ/hr; 1 is 38ℓ/hr |
| Rapid Mixing Method: | Mixing chamber – hydraulic jump |
| Slow Mixing Method : | Flocculation channels |
| Clarifier Type: | Circular clarifier, upflow. |
| Number of Clarifiers: | 4 |
| Total Area of all Clarifiers: | 2156.51m ² |
| Total Capacity of Clarifiers: | For a max design up flow rate of 0.6m/hr, clarifiers are able to treat a capacity of 31Mℓ/day. |
| Filter Type: | Rapid Gravity Sand Filters |
| Number of Filters: | 12 (6 older; 6 newer; same dimensions) |
| Total Filtration Area of all Filters | 192m ² (16m ² each) |
| Total Filtration Design Capacity of all Filters: | At a max filtration rate of 6.73m/hr, filters are able to treat a capacity of 31Mℓ/day |
| Total Capacity of Backwash Water Tanks: | The plant does not have such facility |
| Total Capacity of Sludge Treatment Plant: | The plant does not have such facility |
| Capacity of Used Washwater System: | The plant does not have such facility |
| Primary Post Disinfection Type: | Chlorine gas; 1000kg cylinders |
| Disinfection Dosing Capacity: | 4 kg/hr Chlorinator (the usual dosing rate is 1.6 kg/hr) |
| Disinfectant Storage Capacity: | 2 x 1 ton cylinders |
| Total Treated Water Storage Capacity: | 7.7Mℓ (two concrete clear water reservoirs – capacities of 3.85 Mℓ each) |

Note: this table has been populated using UW 2017 assessments, and information provided by Mr Abre Nel, Superintendent for Alfred Duma LM, uThukela DM staff (13 May 2020)

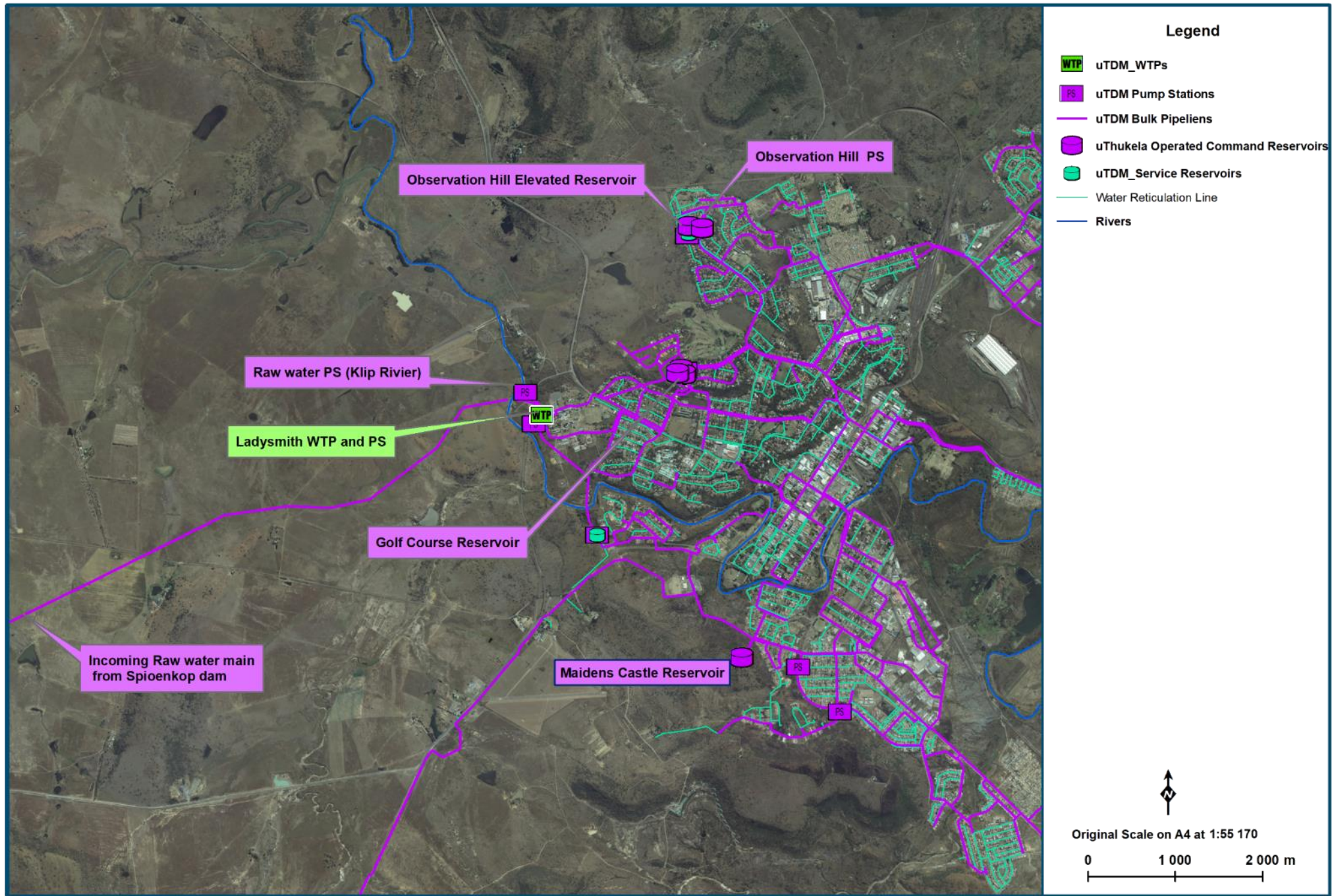

Figure 13.58 Ladysmith WTP Supply System Layout (NGI 2014; Umgeni Water)

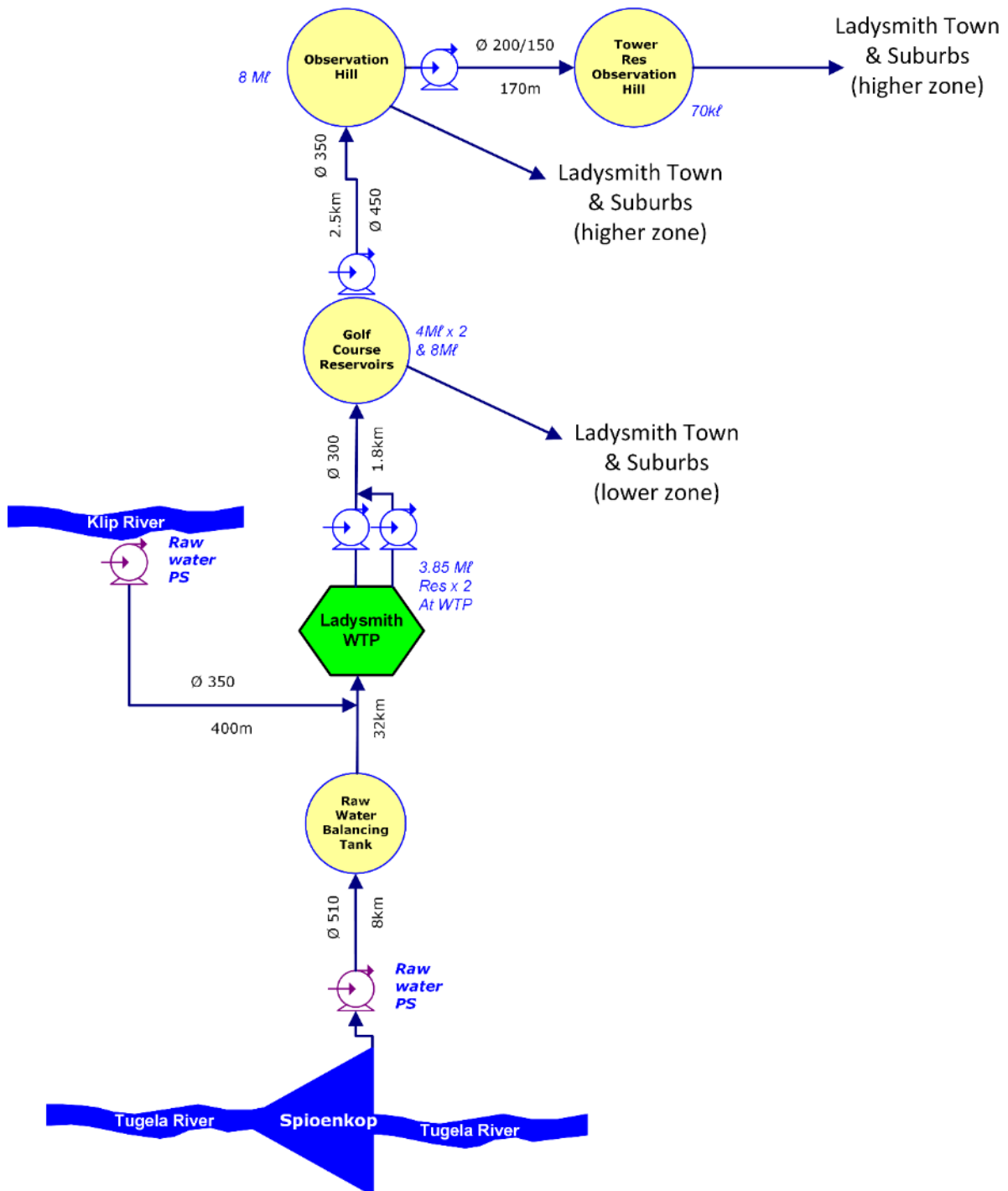

Figure 13.59 Ladysmith WTP Supply System Schematic (not to scale; uTDM Infrastructure)

Table 13.57 Pump details: Ladysmith Raw Water Pump Stations

| System | Pump Station Name | Number of Pumps | | Pump Description | Supply From | Supply To | Static Head (m) | Duty Head (m) | Duty Capacity (Mℓ/day) |
|----------------------------------|---|----------------------|-------------------------|---|---|---------------|-----------------|------------------------|------------------------|
| | | Number of Duty Pumps | Number of Standby Pumps | | | | | | |
| Upper uThukela Upper uThukela | Spioenkop Raw Water Pump Station (Running 2 pumps in 2020) | 2 | 1 | Mather Platt 618.2 S.T.6. MEDI SA.3286 (Main Pumps) | Spioenkop Raw Water Pump Station | Ladysmith WTP | 138.23 | 150.57 | 21.84 running 2 pumps |
| | | 1 | 1 | Mather Platt 12 14 ALE SA. 3286 (Booster pumps) | Spioenkop Raw Water Pump Station | Ladysmith WTP | 138.23 | 25 | 2.8 (per pump) |
| | Klip River Raw Water Raw Water Pump Station | 3 | 0 | KSB ETA 125-315 | Klip River Raw Water Raw Water Pump Station | Ladysmith WTP | 6 | *No info on pump plate | *No info on pump plate |
| | | 2 | 0 | KSB KWP 150-315 | Klip River Raw Water Raw Water Pump Station | Ladysmith WTP | 6 | No info on pump plate | 15.3 running 2 pumps |

*These pumps have not been run in 25 years (design issue); therefore the capacity and head has not been estimated

Table 13.58 Pipeline details: Ladysmith Raw Water Mains

| System | Pipeline Name | From | To | Length (km) | Nominal Diameter (mm) | Material | Capacity (Mℓ/day) | Age (years) |
|----------------|----------------------------------|---|---------------------------|-------------|-----------------------|-------------------------|-------------------|-------------|
| Upper uThukela | Spioenkop Raw Water Rising Main | Spioenkop Raw Water Pump Station | Balancing reservoir (1Mℓ) | 8 | 510 | AC/Steel (Mostly steel) | 31 | 42 |
| | | Balancing reservoir | Ladysmith WTP | 32 | 510 | AC/Steel (Mostly steel) | 31 | 42 |
| | Klip River Raw Water Rising Main | Klip River Raw Water Raw Water Pump Station | Ladysmith WTP | 0.4 | 350 | Steel | 15.3 | 42 |

Table 13.59 Pump details: Ladysmith Clear Water Pump Station (high lift).

| System | Pump Station Name | Number of Pumps | | Pump Description | Supply From | Supply To | Static Head (m) | Duty Head (m) | Duty Capacity (Ml/day) |
|-----------|---|----------------------|-------------------------------|-------------------------------------|--|------------------------|-----------------------------|------------------------|------------------------|
| | | Number of Duty Pumps | Number of Standby Pumps | | | | | | |
| Ladysmith | WTP Clear water Pump station Number 1 (Pump 4) | | 1 (pump still being procured) | KSB (will be smaller than the duty) | Ladysmith WTP: Clear water Pump station Number 1 | Golf course Reservoirs | (pump still being procured) | | |
| | WTP Clear water Pump station Number 1 (Pump 5) | 1 | | KSB Omega 200-520 | Ladysmith WTP: Clear water Pump station Number 1 | Golf course Reservoirs | 40 | 91 | 21.71 |
| | WTP Clear water Pump station 2 (Pump 6 & 7) | 1 | 1 (pump still being procured) | Mather Platt 8/10D-ME | Ladysmith WTP: Clear water Pump station Number 2 | Golf course Reservoirs | 40 | 74.4 | 19.8 |
| | Pump Station to Observation Hill (PS at Golf course) | 1 | 1 | Mather Platt 8 10 CME | Pump Station at Golf course Reservoirs | Observation Hill Res | 40 | 56.388 | 14.7 |
| | Pump Station to Elevated Tower (PS at Observation Hill) | 1 | | SALWEIR YES 80 2926 | Pump Station at Observation Hill | Elevated Tower Res | ±70* | ±85 (No info on plate) | 5* |
| | Pump Station to Elevated Tower (PS at Observation Hill) | | 1 | Wilco /315 | Pump Station at Observation Hill | Elevated Tower Res | ±70* | ±85 (No info on plate) | 5* |

*An estimate provided by Mr Abre Nel, Superintendent for Alfred Duma LM, uThukela DM staff (13 May 2020)

Table 13.60 Reservoir details: Clear water system Reservoirs

| System | Reservoir Site | Reservoir Name | Capacity (Mℓ) | Function | TWL (mASL) | FL (mASL) |
|-----------|--|----------------------------------|---------------|--|------------|-----------|
| Ladysmith | Ladysmith WTP | Clear Water Res 1 | 3.85 | Clear Water Storage, & sump for pump station | 1045 | 1041 |
| | | Clear Water Res 2 | 3.85 | Clear Water Storage, & sump for pump station | 1045 | 1041 |
| | Golf Course (just outside the golf course) | Golf Course Res 1 | *4 | Command reservoir | 1087 | 1080 |
| | | Golf Course Res 2 | *4 | Command reservoir | 1087 | 1080 |
| | | Golf Course Res 3 (rectangular) | *8 | Command reservoir | 1090 | 1085 |
| | Observation Hill | Observation Hill Res | *8 | Command reservoir | 1127.3 | 1119.3 |
| | | Elevated Tower Res (30 m height) | *0.07 | Service reservoir | 1153 | 1123 |
| | | | | | | |
| | | | | | | |

*An informed estimate provided by Mr Abre Nel, Superintendent for Alfred Duma LM, uThukela DM staff (13 May 2020) TBC

Table 13.61 Pipeline details: Clear water bulk Pipeline (rising mains to command reservoirs)

| System | Pipeline Name | From | To | Length (km) | Nominal Diameter (mm) | Material | Capacity (Mℓ/day) | Age (years) |
|-----------|---------------------------------------|---|------------------------|-------------|-----------------------|---------------|-------------------|-------------|
| Ladysmith | Rising Main to Golf course Reservoirs | Ladysmith WTP: Clear water Pump station Number 1 & Pump Station 2 | Golf course Reservoirs | 1800* | 300 | AC CL8* | 9.16 | 42 |
| | Rising Main to Observation Hill Res | Pump Station at Golf course Reservoirs | Observation Hill Res | 2500* | 450 to 350 | Steel CL 16 | 20.62 | 42 |
| | Rising Main to Elevated Tower Res | Pump Station at Observation Hill | Elevated Tower Res | 170* | 200/150 | AC/Steel CL8* | 4.07 | 42 |
| | | | | | | | | |

*Measured length on ARCGIS (approximate), UAP Phase 3 (Umgeni Water, May 2020)

(i) Archie Rodel Water Treatment Plant and Supply System

The Archie Rodel WTP was built in 1952 to supply water to the Estcourt Water Supply Scheme (which is also supplied by George Cross WTW). The design capacity is 12Mℓ/day (Blue drop), however the plant has been producing 10Mℓ/day⁴⁶ for the last 6 months. 11 Mℓ/day is received from the Bushman's River via gravity pipelines. Water meter records are poor due to non-functional water meters. The WTW is in the town of Archie Rodel, next to the highway, and is just within the Alfred Duma Local Municipality.

The co-ordinates of the WTP are:

Latitude (South) -29° 00' 57" Longitude (East) 29° 53' 05"⁴⁷



Figure 13.60 Archie Rodel WTP (Umgeni Water 2017)

The Archie Rodel WTP supplies water to the following areas of Estcourt:

- Estcourt CBD and Estcourt suburbs
- Estcourt industrial area
- Forderville, Kwezi, Mimosadale
- Trenchtown, Putkolsfontein and Rensburg

There is no abstraction pump station for the Archie Rodel Plant. There are two gravity pipelines (400mm Ø AC and a 350mm Ø AC) that run from a weir approximately 2 km upstream of the river that deliver raw water to the head of works. There are isolating valves located on the start and end of these pipelines in order to throttle or stop the flow as required.

The Archie Rodel WTP comprises:

- Coagulant dosing, with mixing via hydraulic jump (weir) at mixing chamber
- Clari-flocculater
- 6 Clarifiers (settling tanks)

⁴⁶ Personal communication, Mr Rajesh Ramlall, Superintendent for Alfred Duma LM, uThukela DM staff (13 May 2020)

⁴⁷ Ascertained from UAP Phase 3 GIS data (Umgeni Water, May 2020)

- 6 Rapid gravity sand filters
- Disinfection (chlorine gas)
- Treated water reservoirs of 1.2 Mℓ
- High lift pump station to the town reservoirs

See **Table 13.62** for further details on the various components of the WTP.

The Archie Rodel WTP process is summarised as follows:

“Raw water from Bushman’s River gravitates to Archie Rodel WW via two pipelines. The pre-treatment process involves polymeric coagulant dosing followed by hydraulic rapid mixing to aid in coagulation. The water is conveyed to two clarifiers i.e. a clari-flocculator and rectangular horizontal flow clarifier (was offline on the day of the assessment). The clarified water quality is further improved through two consecutive settling tanks prior to filtration. The clarified water is conveyed to six rapid gravity filters. Filtered water combines in the filtered water channel and is followed by disinfection and then storage in a reservoir on site. The final treated water is distributed to the town nearby and a hospital”

(Umgeni Water 2017: 2)

Potable water is pumped from the high lift pump station at the Archie Rodel WTP to the Richmond Road reservoirs via a 400mm diameter AC rising main using both a Wilo pump and a Mather Platt 2 stage pump (with one Wilo on standby). There is a junction on this rising main that supplies the Bacon Factory reservoirs. The Richmond Road reservoirs provide 7 Mℓ of storage and serve the Estcourt CBD and suburbs. A 200mm diameter pipeline conveys water via gravity to the Forderville pump station, which pumps up to the Forderville Low reservoir (feeds lower zone of Forderville) via a 160mm diameter uPVC rising main. At the Forderville Low reservoir, there is a pump station (Forderville Low res PS) that pumps up to the Forderville High reservoir (feeds Higher zone of Forderville). A bulk pipeline exists that interlinks the Archie Rodel system to the George Cross system but this has not been used in recent years, as operators of the Estcourt water supply scheme have been able to maintain better control on safe operating pressures by keeping the two systems discrete. From the Archie Rodel WTP, water is also pumped up the Kwezi reservoir (also referred to as the Hospital reservoir) via a 200mm diameter rising main. The Kwezi reservoir supplies bit the hospital and the community of Kwezi with potable water. A further pump station is based at the Kwezi reservoir and lifts water to the Mimosadale reservoirs (total storage of 2.05 Mℓ). This reservoir provides water to the area of Mimosadale.

Figure 13.62 is a supply system schematic that provides an overview of the current distribution arrangement described above. The details of the pump stations, reservoirs, and pipelines are tabled in **Table 13.63**, **Table 13.64**, **Table 13.65** and **Table 13.66**. The original level of service for the informal and lower income areas (Mimosadale, Kwezi, Trenchtown, Putkolsfontein and Rensburg) of this scheme was standpipes, but these were all converted to the yard connection level of service⁴⁸. However, very few customers in these areas pay for water and the water demand in these areas is excessive. This has resulted in a water demand that the Archie Rodel WTP was never designed to sustain. Due to this prevailing issue, there are times when some areas receive less water and have low water pressure. The uTDM maintenance teams are trying to address the water losses in the reticulation systems mentioned above, as the real losses are evident. The Archie Rodel WTP was built in 1952, and cannot continue to sustain the latest water demand of its supply area, nor any future growth. A larger and more efficient WTP should be built in the area of the George Cross WTP that would allow the aging Archie Rodel and George Cross WTPs to be decommissioned.

⁴⁸ Personal communication, Mr Rajesh Ramlall, Superintendent for Alfred Duma LM, uThukela DM staff (June 2020)

Table 13.62 Characteristics of the Archie Rodel WTP.

| | |
|---|--|
| WTP Name: | Archie Rodel WTP |
| System: | Upper uThukela System (Bushmans River) |
| Maximum Design Capacity: | 12 Mℓ/day (Blue Drop 2014) |
| Current Utilisation (May 2020): | 10 Mℓ/day |
| Raw Water Source | Bushmans River |
| Raw Water Storage Capacity: | None |
| Raw Water Supply Capacity: | Rated at 12 Mℓ/day (state maximum) |
| Pre-Oxidation Type: | None |
| Primary Water Pre-Treatment Chemical: | None |
| Coagulant | Sudfloc3870 |
| Total Coagulant Dosing Capacity: | Duty Dosing Pump Capacity = 15ℓ/hr Standby Dosing Pump Capacity = 15ℓ/hr (Currently dosing 10ℓ/hr) |
| Rapid Mixing Method: | Mixing chamber – hydraulic rapid mixing (over a weir) (insufficient mixing energy) |
| Slow Mixing Method : | Clari-flocculators |
| Clarifier Type: | 2 concrete circular upflow clarifiers, 2 concrete secondary horizontal flow settling tanks, 2 concrete tertiary baffled settling tanks |
| Number of Clarifiers (& settling tanks): | 6 |
| Total Area of all Clarifiers: | 172m ² |
| Total Capacity of Clarifiers: | For a design upflow rate of 3m/hr, clarifiers are able to treat a capacity of 12.38Mℓ/day. |
| Filter Type: | Rapid gravity sand filters |
| Number of Filters: | 6 |
| Total Filtration Area of all Filters | 60.6 m ² |
| Total Filtration Design Capacity of all Filters: | For a design filtration rate of 8.5m/hr, filters are able to treat a capacity of 12.3Mℓ/day. |
| Total Capacity of Backwash Water Tanks: | 0kℓ None |
| Total Capacity of Sludge Treatment Plant: | 0kℓ None |
| Capacity of Used Wash water System (recycle): | 0kℓ None |
| Primary Post Disinfection Type: | Chlorine gas; 70kg cylinders |
| Disinfection Dosing Capacity: | 1.5kg/hr Chlorinator (current dosing rate is 0.6kg/hr) |
| Disinfectant Storage Capacity: | 20 x 70kg cylinders |
| Total Treated Water Storage Capacity: | 1.2Mℓ capacity (at the WTP) concrete rectangular reservoir |

*Informed Estimate provided by Rajesh Ramlall, uTDM Superintendent (May2020)

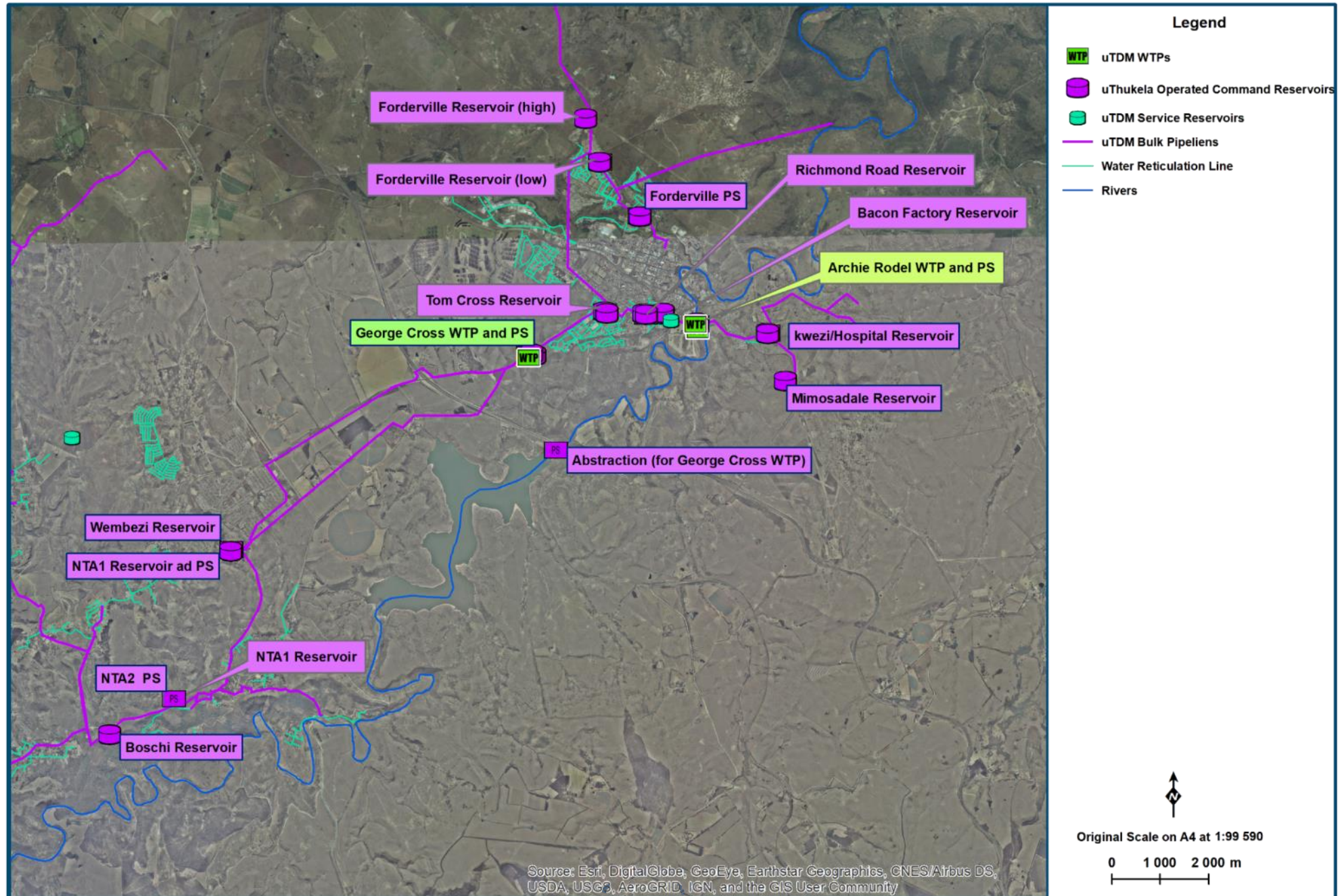

Figure 13.61 Archie Rodel (Estcourt) WTP Supply System Layout (NGI 2014; Umgeni Water 2020) (Note: this map also includes George Cross WTP)

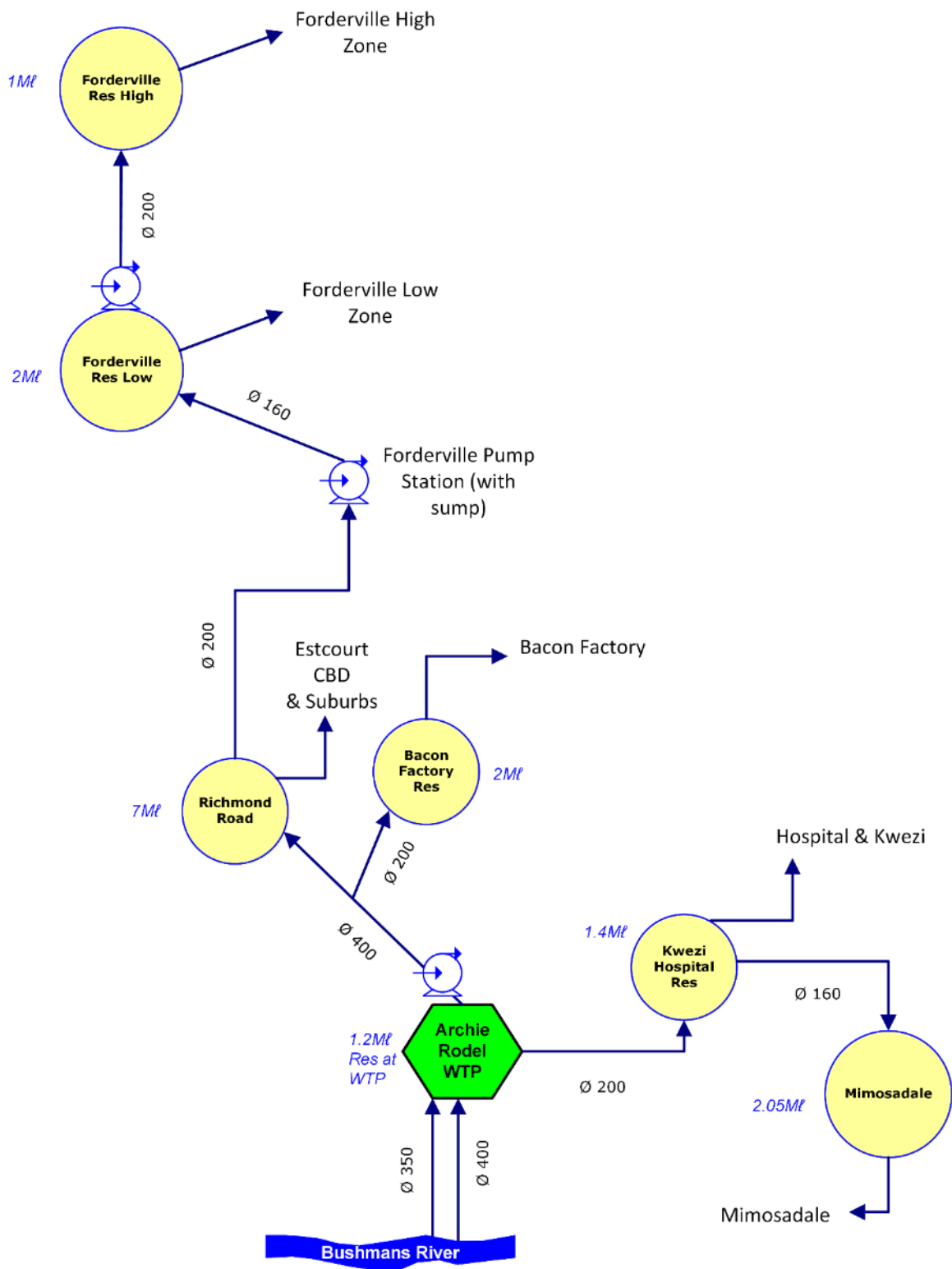

Figure 13.62 Archie Rodel WTP Supply System Schematic (not to scale; uTDM Infrastructure)

Table 13.63 Pipeline details: Archie Rodel Raw Water Gravity Mains

| System | Pipeline Name | From | To | Length (m) | Nominal Diameter (mm) | Material | Capacity (ML/day) | Age (years) |
|----------|---------------------------------------|--|------------------|------------|-----------------------|----------|-------------------|-------------|
| Estcourt | Archie Rodel Raw Water Gravity Main 1 | Archie Rodel Abstraction point on Bushmans River, just 2 km upstream of Estcourt | Archie Rodel WTP | 2000m* | 400 | AC CL8 | 16.29 | 22 |
| Estcourt | Archie Rodel Raw Water Gravity Main 2 | Archie Rodel Abstraction point on Bushmans River, just 2 km upstream of Estcourt | Archie Rodel WTP | 2000m* | 350 | AC CL8 | 12.47 | 68 |

*Informed Estimate provided by Rajesh Ramlall, uTDM Superintendent (May2020)

Table 13.64 Pump details: Archie Rodel Clear Water Pump Stations (high lift).

| System | Pump Station Name | Number of Pumps | | Pump Description | Supply From | Supply To | Static Head (m) | Duty Head (m) | Duty Capacity ML/day |
|------------------------|------------------------------------|----------------------|-------------------------|-----------------------------|-----------------------------|---|-----------------|-----------------------------|----------------------------|
| | | Number of Duty Pumps | Number of Standby Pumps | | | | | | |
| Archie Rodel, Estcourt | Archie Rodel WTP PS | 2 | 1 | KSB ETC NORM 065-050-250 | Archie Rodel WTP PS | Kwezi/Hospital Reservoir | 47.8 | No info on pump plate 70** | No info on pump plate 2* |
| | Kwezi/Hospital Reservoir PS | 1 | 1 | KSB WKLn 65/3 | Kwezi/Hospital Reservoir PS | Mimosadale Reservoir | 123.7 | No info on pump plate 144** | No info on pump plate 1* |
| | Archie Rodel WTP PS | 1 | 1 | Wilo SCP 100-410DS | Archie Rodel WTP PS | Richmond Road Reservoirs (Bacon Factory Reservoirs) | 59.3 (46.6) | No info on pump plate 70** | 3.5 |
| | Archie Rodel WTP PS | 1 | 0 | Mather Platt stage Medivane | Archie Rodel WTP PS | Richmond Road Reservoirs (Bacon Factory Reservoirs) | 59.3 (46.6) | No info on pump plate 70** | No info on pump plate 4.5* |
| | Forderville PS | 2 | 0 | KSB WKLn 100/6 NA | Forderville PS | Forderville Rising Main Low Res | 82.2 | No info on pump plate 103** | 3.2 |
| | Forderville Rising Main Low Res PS | 1 | 1 | KSB ETA 80-40/7 | Forderville Low Res PS | Forderville High Res | 32.62 | No info on pump plate 45** | No info on pump plate |

*Informed Estimate provided by Mr Rajesh Ramlall, uTDM Superintendent (May2020)

**Estimate based on duty capacity and static head (TBC)

Table 13.65 Reservoir details: Clear water system Reservoirs

| System | Reservoir Site | Reservoir Name | Capacity (Mℓ) | Function | *TWL (mASL) | **FL (mASL) |
|----------|--------------------------|---------------------------|-----------------------------------|--|-------------|-------------|
| Estcourt | Archie Rodel WTP | Clear Water WTP reservoir | 1.2 | Clear Water Storage, & sump for pump station. Water required for backwash is also taken from this reservoir. | 1135.5 | 1131.2 |
| | Kwezi/Hospital Reservoir | Kwezi/Hospital Reservoir | 1 (round res) 0.4 (square res) | Command reservoir | 1187 | 1183 |
| | Mimosadale Reservoir | Mimosadale Reservoir | 0.05 (old res) 2 (new res) | Command reservoir | 1310.7 | 1306.7 |
| | Richmond Road Reservoirs | Richmond Road Reservoirs | 5 2 (square res) | Command reservoir | 1198.5 | 1194.5 |
| | Bacon Factory Reservoirs | Bacon Factory Reservoirs | 2 x 1 | Command reservoir | 1182.8 | 1178.8 |
| | Forderville Low Res | Forderville Low Res | 2 | Command reservoir | 1248.62 | 1243.62 |
| | Forderville High Res | Forderville High Res | 1 | Command reservoir | 1281.74 | 1277.24 |

* Informed estimate on height of reservoir provided by Rajesh Ramlall, uTDM Superintendent (May2020)

**Levels obtained from ARCGIS (UAP Phase 3, Umgeni Water, May 2020)

Table 13.66 Pipeline details: Clear water bulk Pipelines

| System | Pipeline Name | From | To | Length (km) | Nominal Diameter (mm) | Material | Capacity (Mℓ/day) | Age** (years) |
|----------|---------------------------------|------------------------------------|----------------------------------|-------------|-----------------------|----------|-------------------|---------------|
| Estcourt | Kwezi/Hospital Rising Main | Archie Rodel WTP PS | Kwezi/Hospital Reservoir | 1.83* | 200 | AC | 4.07 | 68 |
| | Mimosadale Rising Main | Kwezi/Hospital Reservoir PS | Mimosadale Reservoir | 1.36* | 160 | uPVC c16 | 1.9 | 2 |
| | Richmond Rising Main | Archie Rodel WTP PS | Richmond Road Reservoirs | 1.08* | 400 | AC | 16.29 | 68 |
| | Bacon Factory Rising Main | Archie Rodel WTP PS | Bacon Factory Reservoirs | 0.8* | 200 | AC | 4.07 | 68 |
| | Forderville Rising Main | Forderville PS | Forderville Rising Main Low Res | 2.4* | 160 | uPVC c12 | 2.1 | 48 |
| | Forderville Rising Main Low Res | Forderville Rising Main Low Res PS | Forderville Rising Main High Res | 1.1* | 200 | AC | 4.07 | 48 |

*Lengths estimated from available GIS (UAP Phase 3 May 2020)

** Informed estimated by Rajesh Ramlall, uTDM Superintendent (May2020)

(j) George Cross Water Treatment Plant and Supply System

The George Cross WTP was built in 1973 to supply water to the Estcourt Water Supply Scheme. The design capacity is 21 Mℓ/day (Blue drop) however the plant has been producing 22Mℓ/day⁴⁹ for the last 2 years (23Mℓ/day is abstracted from the Wagendrft Dam, which is on the Bushmans River). Water meter records are poor due to non-functional water meters. The WTP is just above the town of Estcourt, next to the highway, and is within the Inkosi Langalibalele Local Municipality.

The co-ordinates of the WTP are:

Latitude (South) -29°01'20" Longitude (East) 29°50' 55"⁵⁰



Figure 13.63 George Cross Water Treatment Plant (Bigen Africa, O & Manual, 2009)

The George Cross WTP supplies water to the following areas of Estcourt:

- Gellington and Drakensview
- Wembezi Township and Ntabamhlope

Raw water is abstracted from the Wagendrft Dam using two duty KSB Omega Pumps and pumped via a 450mm diameter steel pipeline to the head of the works at George Cross WTP. The estimated length of the raw water rising main is 2.2km and the raw water supply capacity is rated at 25 Mℓ/day. See **Table 13.68** for further details on the raw water pumps.

The George Cross WTP comprises:

- Raw water pumps (at the Wagendrft Dam, 2km away)
- Coagulant dosing, with rapid mixing via hydraulic jump (weir) at mixing chamber
- Flocculation channels

⁴⁹ Personal communication, Mr Rajesh Ramlall, Superintendent for Alfred Duma LM, uThukela DM staff (13 May 2020)

⁵⁰ Ascertained from UAP Phase 3 GIS data (Umgeni Water, May 2020)

- 2 Clarifiers
- 9 Rapid gravity sand filters
- Disinfection (chlorine gas)
- Treated water reservoirs of 15 Mℓ
- High lift pump station to the community

See **Table 13.67** for further details on the various components of the WTP.

The George Cross WTP process is summarised as follows:

“The raw water from Wagendrift Dam is pumped to George Cross WW via three pumps. The pre-treatment process involves polymeric coagulant dosing over rapidly flowing raw water to aid in coagulation. The water is then conveyed to two clarifiers for the sedimentation of agglomerated particles. The clarified water is channelled to nine rapid gravity filters. Thereafter, the filtered water combines into a common channel for post chlorination (or disinfection). The final treated water is temporarily stored in two reservoirs on site. The final treated water is distributed to parts of Estcourt and Wembezi community.”

(Umgeni Water 2017: 4)

A gravity AC pipeline of 300mm diameter transfers water from the George Cross WTP via a pair of KSB omega pumps to the Tom Cross Reservoirs which have a total storage volume of 4 Mℓ and supply water to the upper/higher section of the town/CBD of Estcourt (including the suburbs of Gellington and Drakensview). A high lift pump station at the George Cross WTP lifts water to the Wembezi reservoir, which has a capacity of 10 Mℓ. This Wembezi reservoir feeds the upper section of Wembezi. Water is lifted here by the NTA 1 pump station to the NTA 1 reservoir which has a capacity of 400 kℓ. The NTA 1 reservoir feeds the lower portion of Wembezi as well as the upper section of Ntabamhlope. The NTA 2 pump station is adjacent to the NTA 1 reservoir and pumps water up to the Boschi reservoir. The Boschi reservoir supplies water to the lower section of Ntabamhlope. Ntabamhlope is an expansive water supply scheme that continues beyond the Boschi reservoir, by a series of transmission mains and smaller reservoirs.

The original level of service for the area of Ntabamhlope scheme was standpipes, but approximately 70% of the households have already converted to the yard connection level of service (unauthorised connections), many with static tanks⁵¹. However, very few customers in Wembezi and none of the customers in Ntabamhlope pay for water and the water demand in these areas is excessive. This has resulted in a water demand that the George Cross WTP was never designed to sustain. Due to this prevailing issue, there are times when some areas of Ntabamhlope and Wembezi receive less water and have low water pressure. The uTDM maintenance teams are constantly addressing the water losses in the reticulation systems mentioned above, and thus have kept real losses to a minimum. It is the water demand in these two areas that is excessive, more especially Wembezi. The George Cross WTP was built in 1978, and cannot continue to sustain the latest water demand of its supply area, nor any future growth. A larger and more efficient WTP should be built in the area of the George Cross WTP that would allow both the aging Archie Rodel and George Cross WTPs to be decommissioned. A project has just begun at Ntabamhlope to rectify damage to the reticulation caused by vandalism and the illegal connections. A similar type of project is in progress at Wembezi (started in 2019). **Figure 13.65** is a supply system schematic that provides an overview of the current distribution arrangement described above. The details of the pump stations, reservoirs, and pipelines are tabled in **Table 13.68**, **Table 13.69**, **Table 13.70**, **Table 13.71** and **Table 13.72**.

⁵¹ Personal communication, Mr Skosane, Network Superintendent for Alfred Duma LM, uThukela DM staff (June 2020)

Table 13.67 Characteristics of the George Cross WTP.

| | |
|---|--|
| WTP Name: | George Cross WTP |
| System: | Upper uThukela System (Bushmans River) |
| Maximum Design Capacity: | 21 Mℓ/day (O&M Manual) |
| Current Utilisation (April 2020): | 22Mℓ/day |
| Raw Water Source | Wagendrift Dam, Bushmans River |
| Raw Water Storage Capacity: | None at the plant, as the plant is adjacent to the Wagendrift Dam. |
| Raw Water Supply Capacity: | Rated at 25Mℓ/day (state maximums) |
| Pre-Oxidation Type: | None |
| Primary Water Pre-Treatment Chemical: | None |
| Coagulant | SudFloc 3870 |
| Total Coagulant Dosing Capacity: | Duty Dosing Pump Capacity = 17 ℓ/hr Standby Dosing Pump Capacity = 17 ℓ/hr (non-operational) |
| Rapid Mixing Method: | At the weir of the holding tank – downstream of the raw water buffer tank (sufficient mixing energy) |
| Slow Mixing Method : | Flocculation channels |
| Clarifier Type: | Dortmund clarifier, upflow. |
| Number of Clarifiers: | 2 |
| Total Area of all Clarifiers: | 509m ² |
| Total Capacity of Clarifiers: | For a design upflow rate of 2m/hr, clarifiers are able to treat a capacity of 24.4Mℓ/day. |
| Filter Type: | Rapid Gravity Sand Filters |
| Number of Filters: | 9 |
| Total Filtration Area of all Filters | 252m ² |
| Total Filtration Design Capacity of all Filters: | 24Mℓ/day (At a maximum filtration rate of 4m/hr) |
| Total Capacity of Backwash Water Tanks: | 50kℓ (Backwash Recovery) |
| Total Capacity of Sludge Treatment Plant: | Sludge ponds (5Mℓ) |
| Capacity of Used Wash water System: | 50kℓ (Backwash Recovery not operational at present) |
| Primary Post Disinfection Type: | Chlorine gas; 70kg cylinders |
| Disinfection Dosing Capacity: | 1 kg/hr Chlorinator (your usual dosing rate is 0.75kg/hr) |
| Disinfectant Storage Capacity: | 20 x 70kg cylinders |
| Total Treated Water Storage Capacity: | Res 1 is 10Mℓ capacity (in WTP premises); Res 2 is 5Mℓ capacity (just outside the WTP, both on private land) |

Note: This table has been populated using UW 2017 assessments, and information provided by Mr Rajesh Ramlall, Superintendent for Alfred Duma LM, uThukela DM staff (13 May 2020)

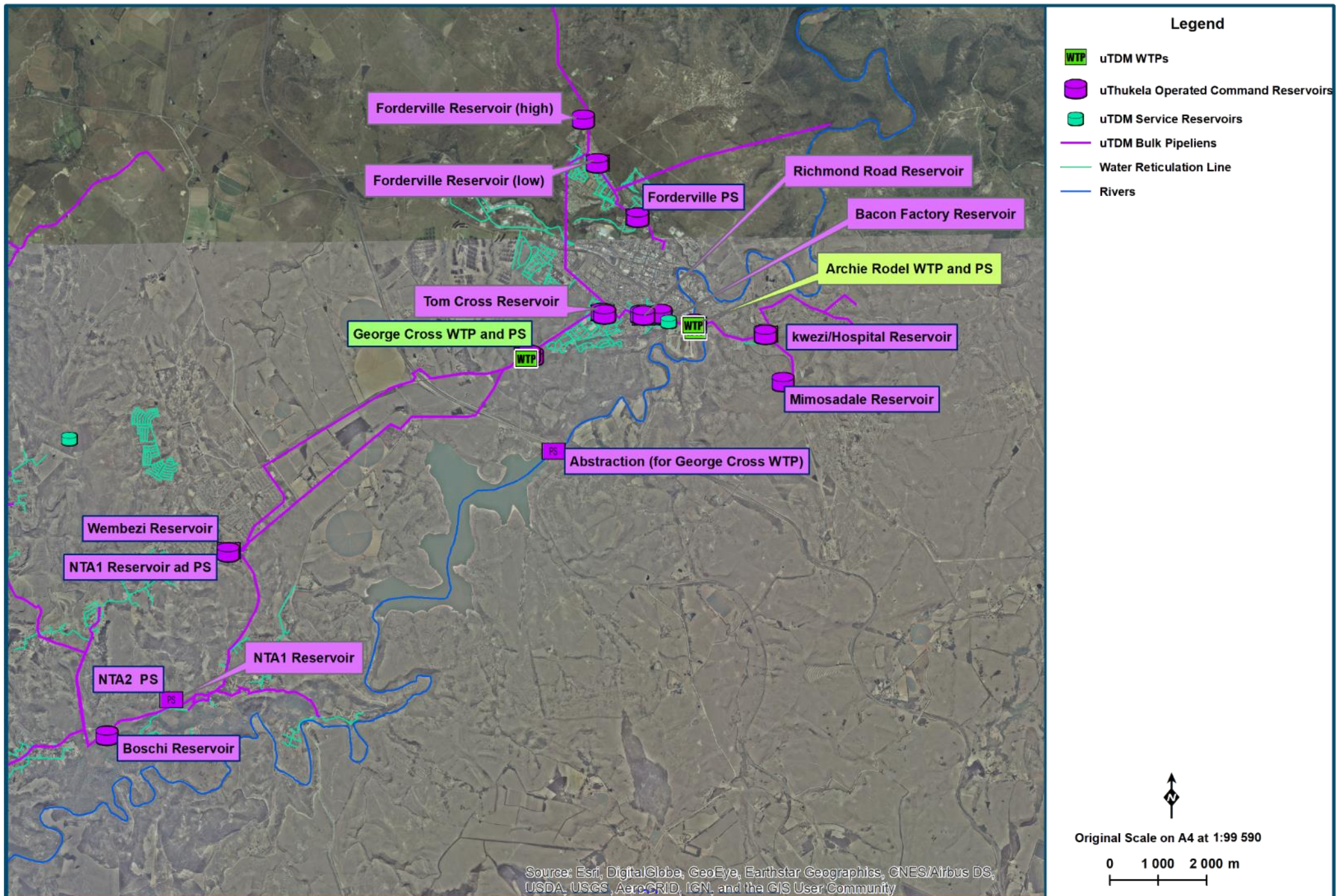

Figure 13.64 George Cross WTP (Estcourt) WTP Supply System Layout (NGI 2014; Umgeni Water 2020) (Note: this map also includes Archie Rodel WTP)

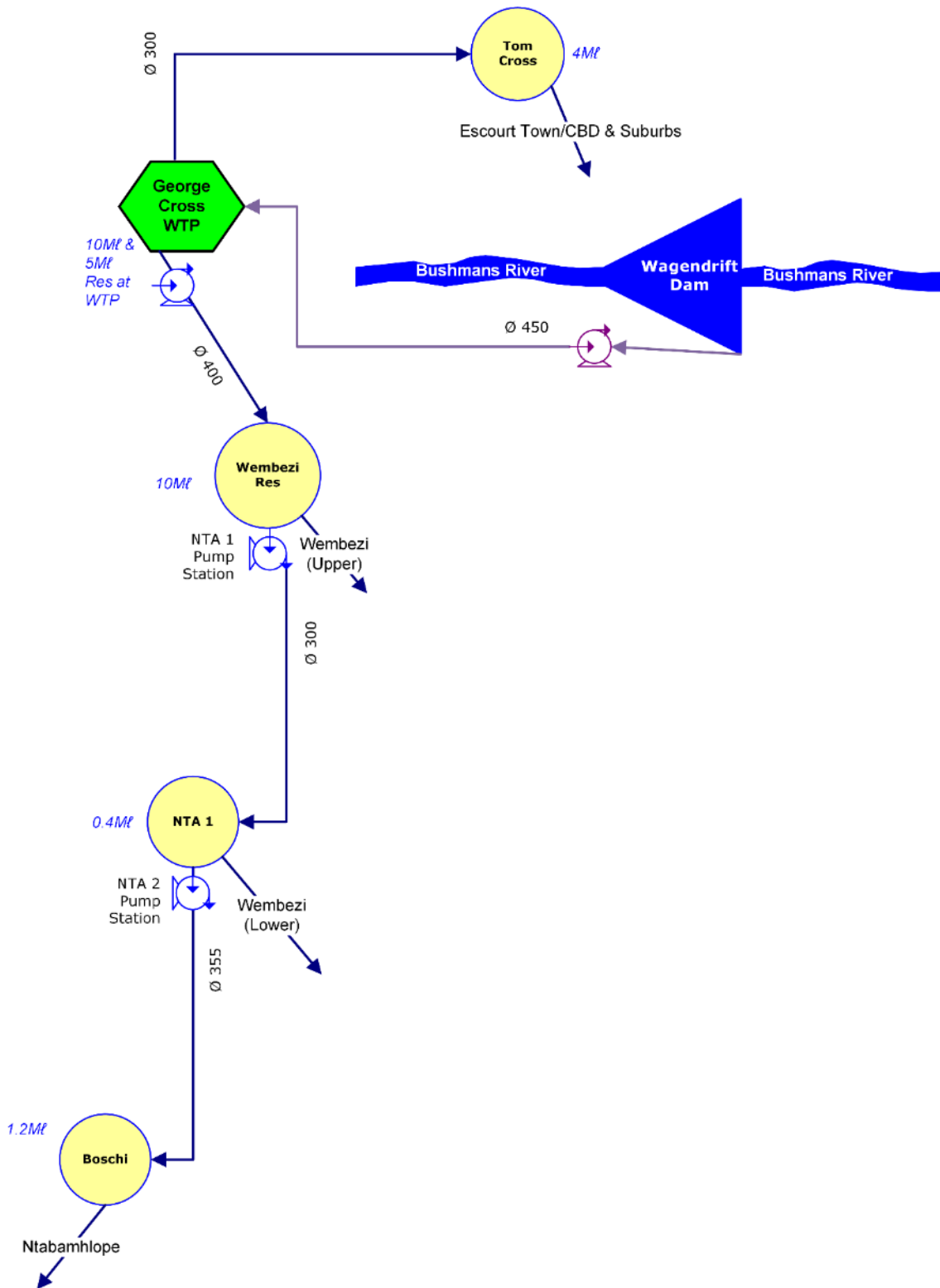

Figure 13.65 George Cross WTP Supply System Schematic (not to scale; uTDM Infrastructure)

Table 13.68 Pump details: George Cross Raw Water Pump Stations

| System | Pump Station Name | Number of Pumps | | Pump Description | Supply From | Supply To | Static Head (m) | Duty Head (m) | Duty Capacity (ML/day) |
|----------|-------------------------------------|----------------------|-------------------------|------------------|----------------|------------------|-----------------|---------------|-------------------------------|
| | | Number of Duty Pumps | Number of Standby Pumps | | | | | | |
| Estcourt | George Cross raw water Pump Station | 2 | 1 ¹ | KSB OMEGA 200 | Wagendrift Dam | George Cross WTW | 16 | 100 | 14 for 1 pump (25 on 2 pumps) |

¹ Currently offline/not in service

Table 13.69 Pipeline details: George Cross Raw Water Rising Mains

| System | Pipeline Name | From | To | Length m | Nominal Diameter (mm) | Material | *Capacity (ML/day) | Age (years) |
|----------|------------------------------------|-----------------------------------|------------------|----------|-----------------------|----------|--------------------|-------------|
| Estcourt | George Cross Raw Water Rising Main | Wagendrift Raw Water Pump Station | George Cross WTP | 2200m* | 450 | Steel | 20.62 | 46 |

*Estimate, based on nominal velocity of 1.5 m/s.

Table 13.70 Pump details: George Cross Clear Water Pump Station (high lift).

| System | Pump Station Name | Number of Pumps | | Pump Description | Supply From | Supply To | Static Head (m) | Duty Head (m) | Duty Capacity (ML/day) |
|----------|-----------------------------------|----------------------|-------------------------|------------------------|--|--------------------|-----------------|------------------|------------------------|
| | | Number of Duty Pumps | Number of Standby Pumps | | | | | | |
| Estcourt | To-Wembezi Pump station | 3 | 1 | KSB ETA 125-50 | George Cross WTP: Wembezi Pump station | Wembezi Reservoirs | 32 | no info on plate | no info on plate |
| | Wembezi NTA1 Res 1 & Pump Station | 1 | 1 | KSB MTC D100 D100/04 | NTA1 Pump Station | NTA2 Pump Station | 212 | 245 | 3.63 |
| | NTA2 Res 1 & Pump Station | 1 | 1 | Grundfos NK 80-250/270 | NTA2 Pump Station & Res | Boschi | 77 | 88.6 | 5.85 |

Table 13.71 Reservoir details: Clear water system Reservoirs

| System | Reservoir Site | Reservoir Name | Capacity (Mℓ) | Function | *TWL (mASL) | **FL (mASL) |
|----------|--|----------------------|---------------|-------------------|-------------|-------------|
| Estcourt | George Cross WTP | Reservoir 1 | 10 | Command reservoir | 1280 | 1272 |
| | Just outside George Cross WTP (private land, apparently) | Reservoir 2 | 5 | Command reservoir | 1282 | 1276 |
| | Estcourt Town (Estcourt CBD) | Tom Cross Reservoirs | 4 | Command reservoir | 1244 | 1239 |
| | Wembezi Community (NTA1 PS) | Wembezi | 10 | Command reservoir | 1321 | 1311 |
| | Ntabamhlope (NTA Res 1) | NTA Res 1 | 0.4 | Command reservoir | 1527 | 1524 |
| | Ntabamhlope, Boschi | Boschi | 1.2 | Command reservoir | 1603 | 1599 |

*Reservoir height is an informed estimate provided by Mr R Ramlall, Superintendent for Alfred Duma LM, uThukela DM staff (May 2020)

**Levels obtained from ARCGIS (UAP Phase 3, Umgeni Water, May 2020)

Table 13.72 Pipeline details: Clear water bulk Pipeline (PIPELINES to command reservoirs)

| System | Pipeline Name | From | To | Length (km) | Nominal Diameter (mm) | Material | *Capacity (Mℓ/day) | Age (years) |
|----------|---|---------------------------------|--|-------------|-----------------------|------------|--------------------|-------------|
| Estcourt | Estcourt Gravity feed from George Cross (gravity) | George Cross WTP | Tom Cross Reservoirs | 2 | 300 | AC CL8 | 9.16 | 47 |
| | Wembezi Rising Main 1 | George Cross WTP | Wembezi (ALSO NTA1 Res 1 & Pump Station) | 8 | 400 | STEEL | 16.3 | 21 |
| | Wembezi Rising Main 1 | George Cross WTP | Wembezi (ALSO NTA1 Res 1 & Pump Station) NTA1 Res 1 & Pump Station | 8 | 300 | AC CL12 | 9.16 | 47 |
| | Ntabamhlope Rising Main 1 | Wembezi Res (NTA1 Pump Station) | Wembezi NTA1 Res & Pump Station 2 | 3.9 | 300 | STEEL | 9.16 | 10 |
| | Ntabamhlope Rising Main 2 | Wembezi NTA2 Res & Pump Station | Boschi Res | 2.3 | 355 | uPVC CL 12 | 10.2 | 10 |

*Estimate, based on nominal velocity of 1.5 m/s.

(k) Weenen Water Treatment Plant and Supply System

The **Old WTP** in Weenen was built in 1997 to supply water to the Weenen Water Supply Scheme. The design capacity is 1.4 Mℓ/day (Blue drop), however the plant has been producing 1.5Mℓ/day⁵² for the last 6 months. 1.4Mℓ/day is abstracted from the irrigation canal (via a 150mm diameter PVC pipeline), which obtains its water from the Bushmans River. Water meter records are poor due to non-functional water meters.

The **New WTP** in Weenen was built in 2015 to assist the Old WTP in supplying water to the Weenen Water Supply Scheme. The design capacity is 2.5 Mℓ/day (uTDM operator) however, the plant has been producing 1.7Mℓ/day⁵³ for the last 6 months. No less than 1.8Mℓ/day is abstracted from the farmer's dam, which is fed by the irrigation canal, which takes its water from the Bushmans River. Water meter records are poor but the water meters on the clear water and the raw water are reported to be functional.

Both water treatment plants are just outside the town of Weenen, and is within the Inkosi Langalibalele Local Municipality. The WTPs are 2.1kms apart and work together daily to supply Weenen and surrounds with potable water.



Figure 13.66 Weenen WTP (Umgeni Water 2017)

The co-ordinates of the **old** WTP are:

Latitude (South) 28°50'15" Longitude (East) 30°04' 34"

The co-ordinates of the **new** WTP are:

Latitude (South) 28°50'36.35" Longitude (East) 30°03' 14.97"⁵⁴

⁵² Personal communication, uTDM staff (May 2020)

⁵³ Personal communication, uTDM staff (May 2020)

⁵⁴ Ascertained from UAP Phase 3 GIS data (Umgeni Water, May 2020)

The Weenen new and old WTPs supplies water to the following areas:

- Weenen town (supplied by the old WTP)
- Kwanobamba (supplied by the new WTP)
- Mtshobotsheni (supplied by the new WTP)
- Thembalihle (supplied by the new WTP)

See **Table 13.76** for further details on the raw water pumps.

The Weenen Old WTP (1.44 Mℓ/day) comprises:

- Raw water holding tank, with raw water pumps (Foros)
- Coagulant dosing, with mixing chamber
- Flocculation column
- 4 Clarifiers
- 4 Pressure filters
- Disinfection (chlorine gas)
- Treated water reservoirs of 0.88Mℓ total storage
- High lift pump station to the community

The Weenen New WTP (2.5 Mℓ/day) comprises:

- Raw water pumps, at the off channel dam adjacent to the New WTP
- Coagulant dosing, injected into raw water pipeline
- Floc basin, with slow mixer
- 3 Clarifiers
- 3 Pressure filters
- Disinfection (chlorine gas)
- Treated water reservoirs of 0.5 Mℓ
- High lift pump station to the community

See **Table 13.73** and **Table 13.74** for further details on the various components of the WTP.

Both the WTPs abstract via 160mm diameter PVC pipelines, using specific raw water pumps.

The Weenen Old WTP process is summarised as follows:

“Raw water from Bushman’s River flows by gravity into the raw water holding tank at the waterworks. The raw water is pumped into a flocculation column, where it is dosed with coagulant at the inlet. There are four circular clarifiers and the clarified water is stored in a buffer tank. Chlorine is dosed into the buffer tank prior to filtration. The disinfected water is pumped into four pressure filters, and the filtrate is stored in two on-site reservoirs. Final water is pumped from reservoir one (rectangular) to the customer. Supply to the customer from reservoir two (circular) is by gravity.”

(Umgeni Water 2017: 6)

Umgeni Water have not assessed the Weenen New WTP yet. Based on information on hand, the process is summarised as follows:

Raw water is abstracted (pumped) from the raw water dam (fed by the irrigation canal off the Bushmans river) adjacent to the WTP and discharged at the head of the works. The coagulant is injected into the raw water pipeline which assists with rapid mixing. Flocculation is achieved by means of a slow mixer in a floc basin. Thereafter, the water flows into 3 rectangular upflow clarifiers. The clarified water flows into a tank that supplies the 3 pressure filters. After filtration, the filtered water is dosed with chlorine gas, and stored in a 500kℓ reservoir, from whence it is pumped up to the community reservoirs. All waste water from the plant is transferred to a sludge pond.

At the old WTP, there are two pump sets for transferring the clear water to the community. A Fors pump set lifts potable water up to the Kwanobamba old reservoir (600kℓ) via a 160mm diameter uPVC rising main. The Kwanobamba old reservoir reticulates water to the lower zone of Kwanobamba. A second pump set (Lowara pumps) at the old WTP pumps water into the reticulation system of Weenen town, specifically the Dirkie Uys system (booster pump).

At the new WTP, there is a Grundfos pump set dedicated to lifting water to the 50 kℓ elevated tank, which assists to feed the town and residential area of Weenen. A further Grundfos pump set transfers potable water to the 1 Mℓ reservoir that feeds the community just north of Weenen. A final Grundfos pump set lifts water to the 2.5 Mℓ reservoir (feeds the higher zone of Kwanobamba). There is an off take on the rising main that transfers water to the Mtshobotsheni reservoir (100kℓ), that feeds the community of Mtshobotsheni.

Figure 13.68 is a supply system schematic that provides an overview of the current distribution arrangement described above.

The details of the pump stations, reservoirs, and pipelines are tabled in **Table 13.75**, **Table 13.76**, **Table 13.77** and **Table 13.78**.

The new WTP is designed and built in a manner that supports future extensions (compartmentalised) and as such could be extended/upgraded to the point where the old WTP could then be decommissioned. Currently, the two WTP are managing well in sustaining the required demand of Weenen, Kwanobamba and Mtshobotsheni. The uTDM has reported that a licence has been made to them for abstraction directly from the Bushmans River, that will enable the new WTP to be extended further, as extraction from the canal is the current key bottleneck in the Weenen WSS. A further option that is recommended by Umgeni Water is to feed the Weenen WSS via a gravity main from a new (future) WTP at Estcourt near the existing George Cross WTP (that would replace George Cross and Archie Rodel WTPs).

Table 13.73 Characteristics of the Weenen Old WTP (1.44 Mℓ/day WTP)

| | |
|---|---|
| WTP Name: | Weenen WTP |
| System: | Upper uThukela System (Bushmans River, irrigation canal) |
| Maximum Design Capacity: | 1.44 Mℓ/day (Blue Drop) mostly limited by the incoming raw water pipe to 1.44 Mℓ/day. |
| Current Utilisation (April 2020): | 1.5 Mℓ/day |
| Raw Water Source | Irrigation canal, off Bushmans River |
| Raw Water Storage Capacity: | 70kℓ* (size of the raw water holding tank) |
| Raw Water Supply Capacity: | Rated at 1.44 Mℓ/day (state maximums) |
| Pre-Oxidation Type: | None |
| Primary Water Pre-Treatment Chemical: | None |
| Coagulant | Zetafloc2753 |
| Total Coagulant Dosing Capacity: | Duty Dosing Pump Capacity = 4ℓ/hr Standby Dosing Pump Capacity = 4ℓ/hr (non operational) Currently set at 20%* |
| Rapid Mixing Method: | Coagulant mixing tank |
| Slow Mixing Method : | Flocculation column |
| Clarifier Type: | Circular clarifier, upflow. |
| Number of Clarifiers: | 4 |
| Total Area of all Clarifiers: | 28.27m ² |
| Total Capacity of Clarifiers: | For a design upflow rate of 2.12m/hr, clarifiers are able to treat a capacity of 1.44Mℓ/day. |
| Filter Type: | Pressure Filters |
| Number of Filters: | 4 |
| Total Filtration Area of all Filters | 4m ² |
| Total Filtration Design Capacity of all Filters: | (Filtration rate is 15m/hr) 1.44Mℓ/day |
| Total Capacity of Backwash Water Tanks: | None |
| Total Capacity of Sludge Treatment Plant: | 3 Sludge drying beds exist, but were not being used, as they are in disrepair. Dimensions unknown. Sludge goes back to canal. |
| Capacity of Used Wash water System: | None. Goes back to canal. |
| Primary Post Disinfection Type: | Chlorine gas; 70kg cylinders |
| Disinfection Dosing Capacity: | 500g/hr Chlorinator (dosing rate is 300g/hr*) |
| Disinfectant Storage Capacity: | 3 x 70kg cylinders |
| Total Treated Water Storage Capacity: | Res 1 is 0.5Mℓ capacity (circular), Res 2 is 0.380Mℓ capacity (rectangular, poor condition) (both at the WTP). Unmetered. |

*Information provided by uTDM staff (May 2020)

Table 13.74 Characteristics of the Weenen New WTP (2.5 Mℓ/day WTP)

| | |
|---|---|
| WTP Name: | Weenen WTP |
| System: | Upper uThukela System (Bushmans River, irrigation canal) |
| Maximum Design Capacity: | 2.5 Mℓ/day |
| Current Utilisation (April 2020): | 1.7 Mℓ/day |
| Raw Water Source | Storage pond/tank/dam (Bushmans River, irrigation canal) |
| Raw Water Storage Capacity: | 150 Mℓ |
| Raw Water Supply Capacity: | Rated at 2.8Mℓ/day (state maximums) |
| Pre-Oxidation Type: | None |
| Primary Water Pre-Treatment Chemical: | None |
| Coagulant | Zetafloc2753 |
| Total Coagulant Dosing Capacity: | Duty Dosing Pump Capacity = 30ℓ/hr (not operational) Standby Dosing Pump Capacity = 30ℓ/hr (not operational) Currently dosing 1ℓ/hr |
| Rapid Mixing Method: | Injected into raw water pipeline |
| Slow Mixing Method : | Slow mixer in floc basin |
| Clarifier Type: | Rectangular clarifier, upflow. |
| Number of Clarifiers: | 3 |
| Total Area of all Clarifiers: | 13.5 (4.5m ² each*) |
| Total Capacity of Clarifiers: | For a design upflow rate of 7.7m/hr, clarifiers are able to treat a capacity of 2.5Mℓ/day. |
| Filter Type: | Pressure Filters |
| Number of Filters: | 3 |
| Total Filtration Area of all Filters | 9m ² (3m ² each*) |
| Total Filtration Design Capacity of all Filters: | 2.6 Mℓ/day (Filtration rate is 12m/hr) |
| Total Capacity of Backwash Water Tanks: | None, flows into sludge pond |
| Total Capacity of Sludge Treatment Plant: | sludge pond |
| Capacity of Used Wash water System: | None |
| Primary Post Disinfection Type: | Chlorine gas; 70kg cylinders |
| Disinfection Dosing Capacity: | 500g/hr Chlorinator (your usual dosing rate is 50g/hr) |
| Disinfectant Storage Capacity: | 20 x 70kg cylinders |
| Total Treated Water Storage Capacity: | Res 1 is 500kℓ capacity (circular) |

*Information provided by uTDM staff (May 2020)

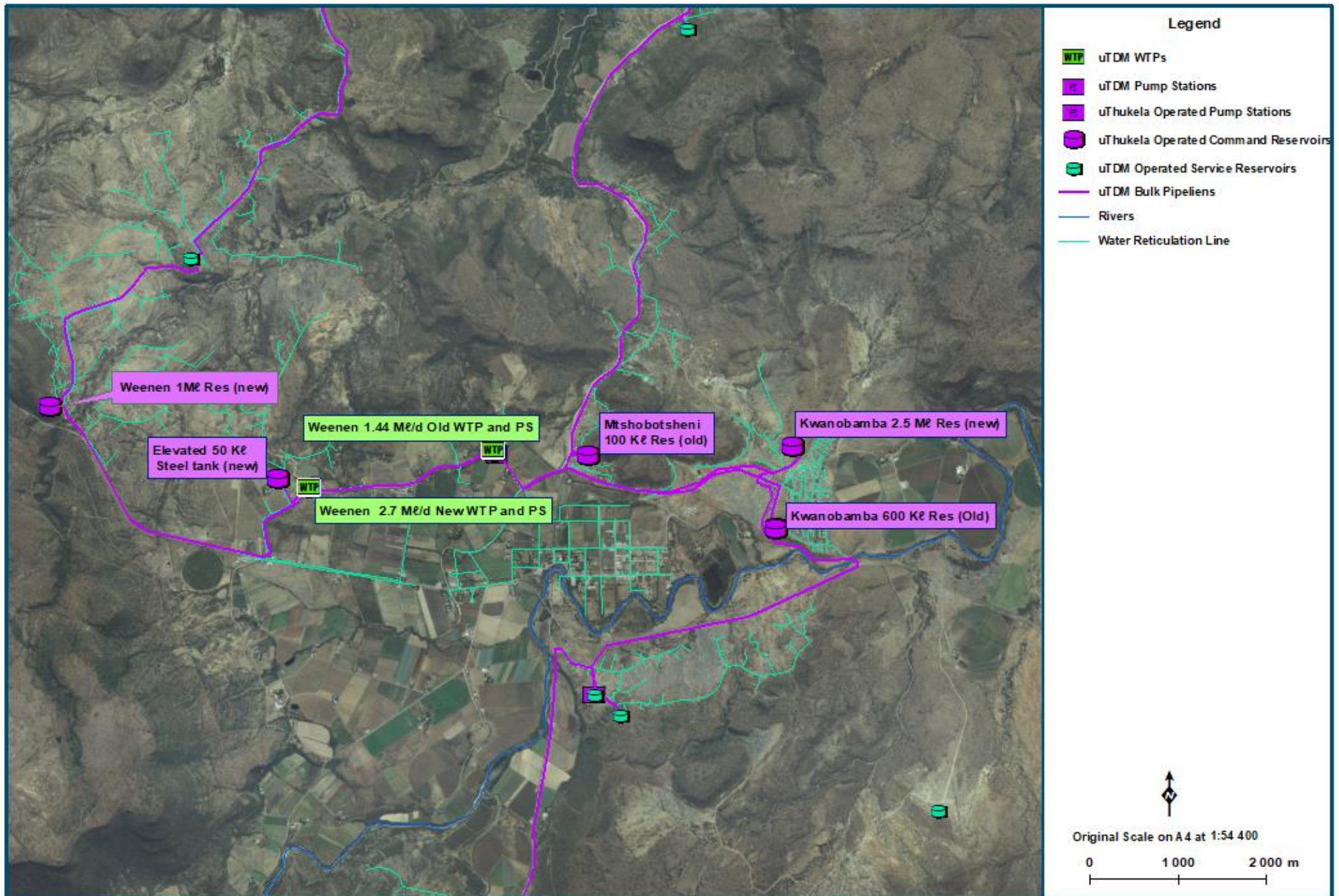

Figure 13.67 Weenen WTP Supply System Layout (NGI 2014; Umgeni Water 2020)

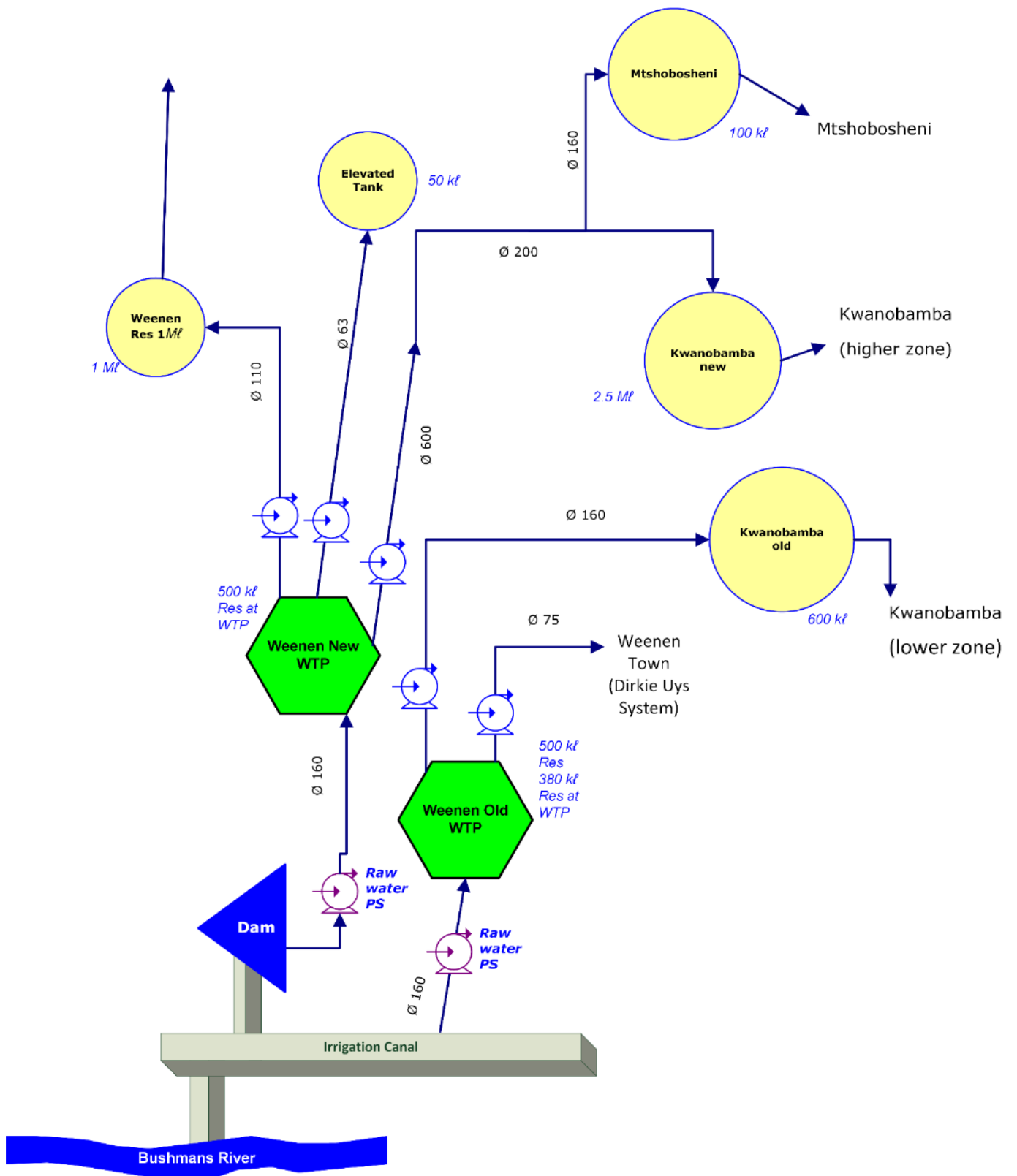

Figure 13.68 Weenen WTP (Old WTP and New WTP) Supply System Schematic (not to scale; uTDM Infrastructure)

Table 13.75 Pipeline details: Weenen Raw Water Gravity Mains

| System | Pipeline Name | From | To | Length (m) | Nominal Diameter (mm) | **Material | *Capacity (Mℓ/day) | Age (years) |
|--------|--|---------------------------|----------------|------------|-----------------------|------------|--------------------|-------------|
| Weenen | Weenen Raw Water Gravity Main, Old WTP | Weenen Irrigation Channel | Weenen Old WTP | 25* | 160 | PVC | 1.44 | 23 |
| Weenen | Weenen Raw Water Gravity Main, New WTP | Weenen farmers dam | Weenen New WTP | 45* | 160 | PVC | 2.2 | 5 |

*As obtained from uTDM staff (May 2020)

**TBC if uPVC, mPVC or oPVC

Table 13.76 Pump details: Weenen Pump Stations

| System | Pump Station Name | Number of Pumps | | Pump Description | Supply From | Supply To | Static Head (m) | Duty Head (m) | Duty Capacity (Mℓ/day) |
|--------|--------------------------------|----------------------|-------------------------|-------------------------------|---|-------------------------------|-----------------|------------------|------------------------|
| | | Number of Duty Pumps | Number of Standby Pumps | | | | | | |
| Weenen | Raw water pumps old WTP | 1 | 1 | Foros (model unknown) | Raw water tank | Weenen Old WTP | 3 | No info on plate | No info on plate |
| | Raw water pumps new WTP | 1 | 1 | Unknown | Raw water dam | Weenen New WTP | 5 | No info on plate | No info on plate |
| | Low lift Town pumps – Weenen | 1 | 1 (gone for repairs) | Lowara (model unknown) | Weenen Old WTP, Low Lift PS | Weenen town (Dirkie Uys area) | N/A | 49.8 | 4.1 |
| | Kwanobamba High Lift pump | 1 | 1 (gone for repairs) | Foros (model unknown) | Kwanobamba High Lift pump, Weenen Old WTP PS | Kwanobamba reservoir 600kl | -1 | No info on plate | No info on plate |
| | PS to 50kl Elevated Steel Tank | 1 | 1 | Grundfos 85U085908 | Weenen New WTP PS for Elevated tank | 50kl Elevated Steel tank | 30 | 48.3 | 0.24 |
| | PS to new 1Mℓ Res | 1 | 1 | Grundfos 896122807 P11629 | Weenen New WTP PS for 1Mℓ Res | New 1Mℓ Res | 50 | 121.1 | 1.08 |
| | PS to new 2.5Mℓ Res | 1 | 1 | Grundfos B9854636 1P316240001 | Weenen New WTP PS for 2.5Mℓ Res (& feeds Mtshobotsheni Res along the way) | New 2.5Mℓ Res | -2.26 | 57.5 | 5.35 |

Table 13.77 Weenen Reservoir details: Clear water system Reservoirs

| System | Reservoir Site | Reservoir Name | *Capacity (Mℓ) | Function | ***TWL (mASL) | **FL (mASL) |
|--------|--------------------------|---|----------------|-------------------|---------------|-------------|
| Weenen | Old WTP Weenen | Weenen Old WTP 380kℓ | 0.38 | Command reservoir | 892.64 | 882.64 |
| | Old WTP Weenen | Weenen Old WTP reservoir 500kℓ | 0.5 | Command reservoir | 888.64 | 882.64 |
| | New WTP Weenen | Weenen New WTP reservoir 500kℓ | 0.5 | Command reservoir | 906 | 900 |
| | Kwanobamba | Kwanobamba reservoir 600kℓ | 0.6 | Command reservoir | 891.71 | 881.71 |
| | New WTP Weenen | Weenen New WTP 50kℓ Elevated Steel tank | 0.05 | Command reservoir | 930 | 927 |
| | Weenen New 1Mℓ Res | New Weenen 1Mℓ Res | 1 | Command reservoir | 958 | 950 |
| | Kwanobamba New 2.5Mℓ Res | New Kwanobamba 2.5Mℓ Res | 2.5 | Command reservoir | 912.26 | 904.26 |
| | Mtshobotsheni Res | Mtshobotsheni Res | 0.1 | Command reservoir | 874.76 | 872.76 |

***Based on estimates of reservoir height by uTDM staff (May 2020)

**Based on ARCGIS information, UAP Phase 3 (Umgeni Water, May 2020)

* Based on personal communication with uTDM staff (May 2020)

Table 13.78 Weenen Pipeline details: Clear water bulk Pipeline (and rising mains to command reservoirs)

| System | Pipeline Name | From | To | **Length (km) | *Nominal Diameter (mm) | *Material | ***Capacity (Mℓ/day) | *Age (years) |
|--------|--|--|-------------------------------|---------------|------------------------|-----------------|----------------------|--------------|
| Weenen | Weenen Rising Main | Weenen Old WTP, Low Lift PS | Weenen town (Dirkie Uys area) | 5 | 75 | uPVC cl unknown | 0.45 | 18 |
| | Kwanabamba Rising Main | Kwanobamba High Lift pump, Weenen Old WTP PS | Kwanobamba reservoir 600kℓ | 4.2 | 160 | uPVC cl unknown | 2.33 | 23 |
| | Rising Main: Weenen New WTP PS for Elevated tank | Weenen New WTP PS for Elevated tank | 50kℓ ElevatedSteel tank | 0.60 | 63 | HDPE cl unknown | 0.345 | 5 |
| | Rising Main: Weenen New WTP PS for 1Mℓ Res | Weenen New WTP PS for 1Mℓ Res | New 1Mℓ Res | 4.33 | 110 | uPVC cl unknown | 1.04 | 5 |
| | Rising Main: Weenen New WTP PS for 2.5Mℓ Res | Weenen New WTP PS for 2.5Mℓ Res | New 2.5Mℓ Res | 6.4 | 200 | uPVC cl unknown | 3.5 | 5 |
| | Mtshobotsheni Gravity Main | (tee off from above rising main for 2.5Mℓ Res) | Mtshobotsheni Res | 0.8 | 160 | uPVC cl unknown | 2.33 | 5 |

***Based on estimates using a nominal flow velocity of ± 1.5 m/s (no historic meter readings available on these pipelines)

**Based on ARCGIS information, UAP Phase 3 (Umgeni Water, May 2020)

* Based on personal communication with uTDM staff (May 2020)

(l) Tugela Ferry Water Treatment Plant and Supply System

The Tugela Ferry WTP was built in 2005 to supply water to the Tugela Ferry Water Supply Scheme. The design capacity is 3 ML/day (Blue drop), however the plant has been producing 3.5ML/day⁵⁵ for the last 6 months. 4 ML/day is abstracted from the Tugela River, where it is treated at the Tugela Ferry WTW. Water meter records are poor due to non-functional water meters. The WTW is just above the settlements of Tugela Ferry and is within the Msinga Local Municipality.

The co-ordinates are:

Latitude (South) 28°44'39.41"

Longitude (East) 30°22'56.51"⁵⁶

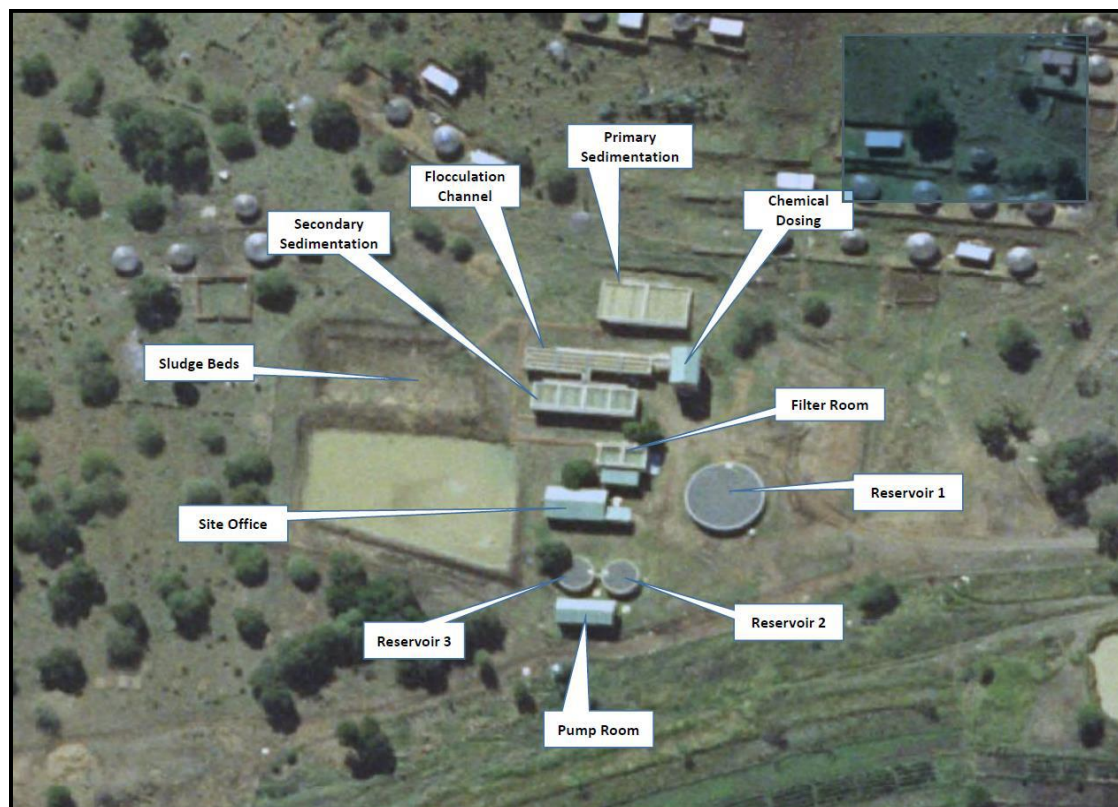

Figure 13.69 Overview of Tugela Ferry WTP, uMzinyathi DM O&M Manual (Dec2016)

The Tugela Ferry WTP supplies water to the following areas:

- Tugela Ferry (town)
- Ngubo
- Ngcengeni
- Mthembu West
- Malomeni
- Mbabane
- Esidakini

⁵⁵ Personal Communication, Mr Ardeep Munessar , Area Engineer, uThukela DM (24 March 2020)

⁵⁶ Ascertained from UAP Phase 3 GIS data (Umgeni Water, May 2020)

See **Table 13.80** for further details on the raw water pumps.

The Tugela Ferry WTP comprises:

- Coagulant dosing, with rapid mixing via hydraulic jump (weir) at mixing chamber
- Flocculation channels
- 4 rectangular Clarifiers
- 2 Rapid gravity sand filters
- Disinfection (chlorine gas)
- Treated water reservoirs of 1Mℓ
- High lift pump station to the Command reservoir 1.4km away.

See **Table 13.79** for further details on the various components of the WTP.

Umgeni Water have not assessed the Tugela Ferry WTP yet. Based on information on hand, the process is summarised as follows:

Raw water is abstracted from the uThukela River by a pair of Gorman Rupp T6 pumps which discharge into the raw water settling tanks (2 x 400kℓ). The raw water is dosed with coagulant at the entrance to the floc channels. The water passes through the floc channels and onwards to the four rectangular upflow clarifiers. The clarified water is then sent to the two rapid gravity filters. The filtered water is dosed with chlorine gas and stored in a 1 Mℓ reservoir on site. A high lift pump station conveys the treated water to the Command reservoir 1.4km away.

The rising main from the Tugela Ferry WTP is a 250mm diameter uPVC pipeline and pumps up to the 550kℓ Command reservoir, which supplies Sampofu with potable water. There are 3 pump sets within the high lift pump station at the Command reservoir. A Grundfos pump set conveys water to the 500kℓ Mthembu West (supplies Mthembu West) reservoir via 110mm diameter uPVC pipeline. A KSB pump set conveys water to the 100kℓ Ngubo reservoir (supplies Ngubo area) via a 160mm diameter uPVC pipeline. A Wilo pump set conveys water to the 50 kℓ Ncengeni reservoir (supplies Ncengeni area) via a 50mm diameter uPVC pipeline. A 160mm diameter gravity main emanates from the 550kℓ reservoir and supplies the 850 kℓ Command reservoir (and the new 1Mℓ reservoir next to it). These two reservoirs (850 kℓ and the 1 Mℓ) are referred to as the 850 reservoir (historic name). It supplies the Hospital and the Tugela Ferry town (and residential area) with potable water. There is a high lift pump station at the 850 that pumps up to Reservoir B via a 160mm diameter uPVC pipeline. Reservoir consists of an older 250kl reservoir and the a new 500kl reservoir. Reservoir B also feeds Reservoir C by means of a 160mm diameter uPVC gravity pipeline. Reservoir B and C also feed the Tugela Ferry town (and residential area) with potable water.

Figure 13.71 is a supply system schematic that provides an overview of the current distribution arrangement described above.

The details of the pump stations, reservoirs, and pipelines are tabled in **Table 13.80**, **Table 13.81** and **Table 13.82**.

Table 13.79 Characteristics of the Tugela Ferry WTP.

| | |
|---|--|
| WTP Name: | Tugela Ferry WTP |
| System: | Upper uThukela System (uThukela River) |
| Maximum Design Capacity: | 3.5 Mℓ/day (Blue Drop) |
| Current Utilisation (April 2020): | 3.5 Mℓ/day |
| Raw Water Source | uThukela River |
| Raw Water Storage Capacity: | 800 kℓ (2x400 kℓ raw water settling tanks) |
| Raw Water Supply Capacity: | Rated at 8 Mℓ/day (new abstraction infrastructure) |
| Pre-Oxidation Type: | None |
| Primary Water Pre-Treatment Chemical: | None |
| Coagulant | Rheofloc 5498 |
| Total Coagulant Dosing Capacity: | Duty Dosing Pump Capacity = 13.1ℓ/hr Standby Dosing Pump Capacity = 13.1ℓ/hr |
| Rapid Mixing Method: | At the entrance to the floc channels |
| Slow Mixing Method : | Flocculation channels |
| Clarifier Type: | Dortmund clarifier, rectangular, up flow. |
| Number of Clarifiers: | 4 |
| Total Area of all Clarifiers: | 48 m ² (12m ² each) |
| Total Capacity of Clarifiers: | For a design upflow rate of 3.1m/hr, clarifiers are able to treat a capacity of 3.5Mℓ/day. |
| Filter Type: | Rapid Gravity Filters |
| Number of Filters: | 2 |
| Total Filtration Area of all Filters | 50m ² (25m ² each) |
| Total Filtration Design Capacity of all Filters: | Filtration rate of 3m/hr = 3.6Mℓ/day |
| Total Capacity of Backwash Water Tanks: | All backwash sent to sludge lagoons (200 kℓ) |
| Total Capacity of Sludge Treatment Plant: | Sludge lagoons (200 kℓ) |
| Capacity of Used Wash water System: | 0kℓ/d (No Backwash Recovery) |
| Primary Post Disinfection Type: | Chlorine gas; 70kg cylinders |
| Disinfection Dosing Capacity: | 1 kg/hr Chlorinator (the usual dosing rate is 400g/hr) |
| Disinfectant Storage Capacity: | 9 x 70kg cylinders |
| Total Treated Water Storage Capacity: | 1 Concrete Reservoir, 1000 kℓ capacity (in WTP premises) |

*Table populated through Personal Communication, Mr Ardeep Munessar , Area Engineer, uThukela DM (24 March 2020)

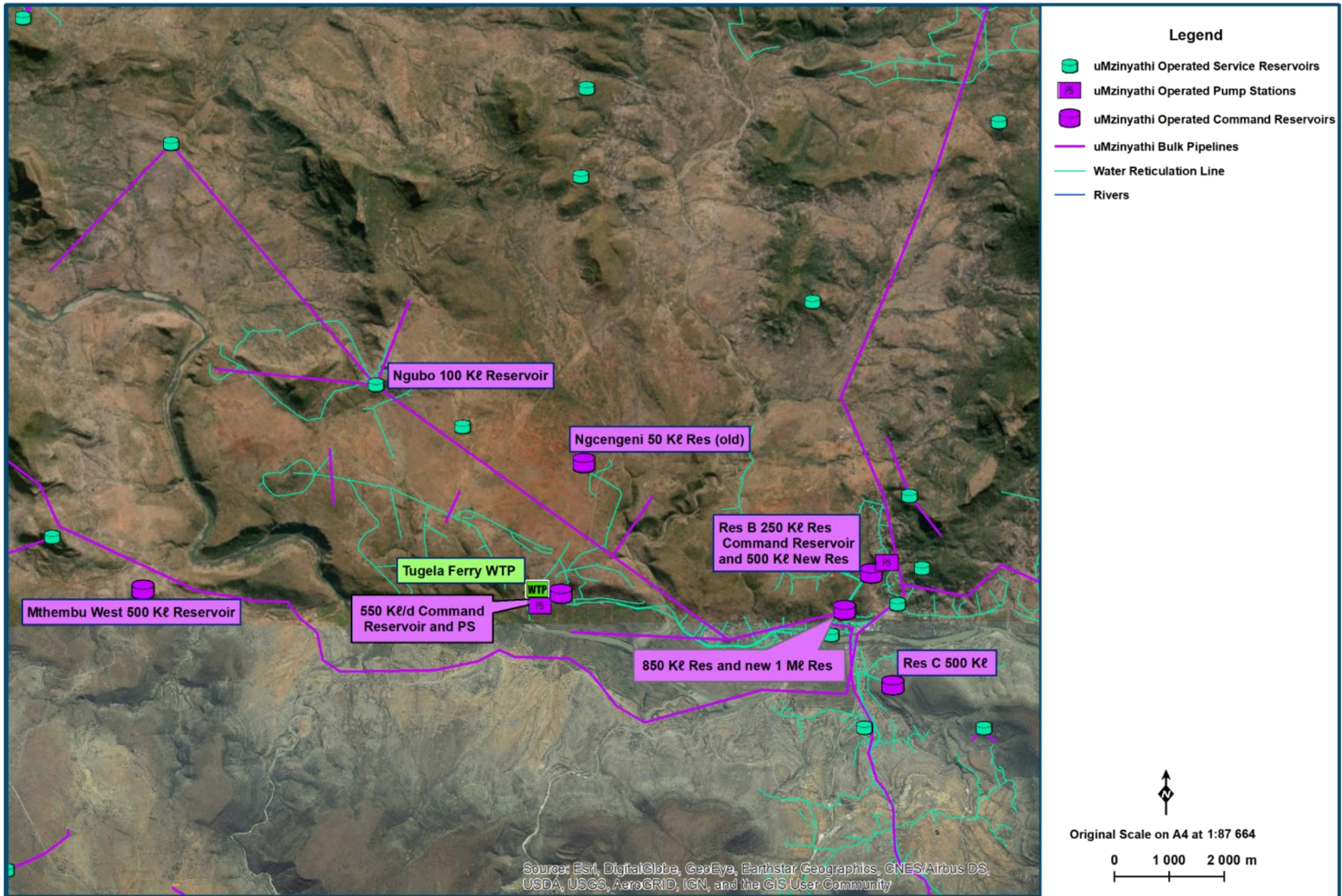

Figure 13.70 Tugela Ferry WTP Supply System Layout (NGI 2014; Umgeni Water 2020)

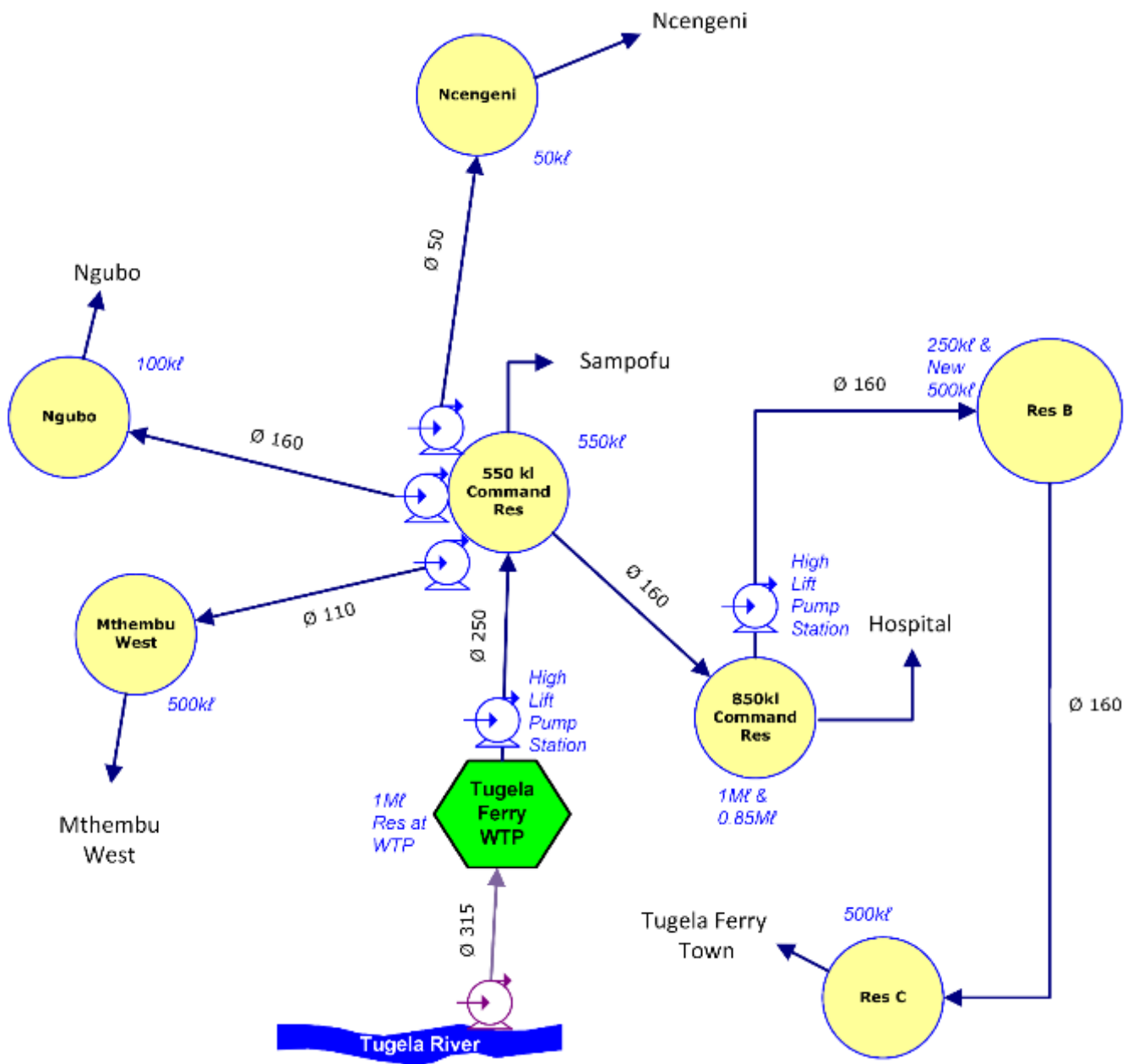

Figure 13.71 Tugela Ferry WTP Supply System Schematic (not to scale; uMzinyathi DM Infrastructure)

Table 13.80 Pump details: Tugela Ferry Pump Stations

| System | Pump Station Name | Number of Pumps | | Pump Description | Supply From | Supply To | Static Head (m) | Duty Head (m) | Duty Capacity (Mℓ/day) |
|------------------------|--|----------------------|-------------------------|--|--|----------------------------|-----------------|-------------------|--------------------------|
| | | Number of Duty Pumps | Number of Standby Pumps | | | | | | |
| Tugela Ferry | Tugela Ferry WTP High Lift CW pump station | 1 | 1 | KSB WKLn 125/5 (imp dia 320mm) | Tugela Ferry WTP (High Lift CW pump station) | Tugela Ferry 550 Reservoir | 117* | no info on plate. | no info on plate. 3.5*** |
| | 550kl Res Tugela Ferry Pump Station | 1 | 1 | KSB WKLn 65/4 (imp dia full size) | 550 Res Tugela Ferry PS | Ngubo Res | 131* | no info on plate. | no info on plate. |
| | | 1 | | wilo MC 605N-DM | 550 Res Tugela Ferry PS | Ngcengeni | 10* | 58 | 168 |
| | | | 1 | wilo MHI 1604-1/E/3-400-50-2/IE3 | 550 Res Tugela Ferry PS | Ngcengeni | 10* | 48 | 168 |
| | | 1 | | Grundfos DL16-160 (stainless steel, centrifugal) | 550 Res Tugela Ferry PS | Mthembu West | 119* | 184 | 0.384 |
| | | | 1 | Grundfos DL16-140 (stainless steel, centrifugal) | 550 Res Tugela Ferry PS | Mthembu West | 119* | 162 | 0.384 |
| | 850kl Res Tugela Ferry Pump Station | 1 | 1 | KSB WKLn 65/3 (imp dia full size) | 850 Res Tugela Ferry PS | Tugela Ferry Res B | 75* | no info on plate. | no info on plate. |
| Tugela Ferry Raw Water | Tugela Ferry Raw Water Abstraction | 2 | 1 | Gorman Rupp T6 | uThukela River | Tugela Ferry WTP | 12* | 30** TBC | 4*** |

*As ascertained from ARCGIS, UAP Phase 3, Umgeni Water, May 2020

**Estimate based on the static head and the reported duty capacity (TBC)

***Estimate provided by Area Engineer, Ardeep Munessar, uMzinyathi DM staff (May 2020)

Table 13.81 Reservoir details: Tugela Ferry Clear Water System Reservoirs

| System | Reservoir Site | Reservoir Name | Capacity (kℓ) | Function | TWL (FSL) (mASL) | *FL (mASL) |
|--------------|-------------------------------|-------------------------------|--------------------------------------|-------------------|------------------|------------|
| Tugela Ferry | Tugela Ferry WTP | WTP Reservoir | 1000 | Command reservoir | 557 | 553 |
| | Tugela Ferry | Tugela Ferry 550 kl Reservoir | 550 | Command reservoir | 688.5 | 683 |
| | Ngubo Res | Ngubo Res | 100 | Service reservoir | 816 | 814 |
| | Ngcengeni | Ngcengeni | 50 | Service reservoir | 694 | 692 |
| | Mthembu West | Mthembu West | 500 | Service reservoir | 806 | 802 |
| | Tugela Ferry 850 kl Reservoir | Tugela Ferry 850 kl Reservoir | 850 (also new 1000 built next to it) | Command reservoir | 630 | 625 |
| | Tugela Ferry Res B | Tugela Ferry Res B | 250 (also new 500 built next to it) | Command reservoir | 712 | 710 |

*As ascertained from ARCGIS, UAP Phase 3, (Umgeni Water, May 2020)

Table 13.82 Pipeline details: Tugela Ferry Water bulk Pipelines

| System | Pipeline Name | From | To | Length (km) | *Nominal Diameter (mm) | *Material | Capacity (Mℓ/day) | Age (years) |
|--------------|---|--|-------------------------------|-------------|------------------------|-----------|-------------------|-------------|
| Tugela Ferry | Tugela Ferry 550 kl Reservoir Rising Main | Tugela Ferry WTP (High Lift CW pump station) | Tugela Ferry 550 kl Reservoir | 1.4 | 250 | uPVC | 4.9 | 15 |
| | Ngubo Res Rising Main | 550kl Res Tugela Ferry PS | Ngubo Res | 6 | 160 | uPVC | 1.9 | 15 |
| | Ngcengeni Rising Main | 550kl Res Tugela Ferry PS | Ngcengeni | 1.33 | 50 | uPVC | 0.019 | 15 |
| | Mthembu West Rising Main | 550kl Res Tugela Ferry PS | Mthembu West | 8.4 | 110 | uPVC | 0.9 | 15 |
| | Tugela Ferry Res B | 850kl Res Tugela Ferry PS | Tugela Ferry Res B | 0.67 | 160 | uPVC | 1.9 | 15 |
| | 850kl Res Tugela Gravity Main | 550kl Res Tugela Ferry | 850kl Res Tugela | 6.1 | 160 | uPVC | 1.9 | 15 |
| | Gravity Main to Res C | Tugela Ferry Res B | Tugela Ferry Res C | 2.65 | 160 | uPVC | 1.9 | 15 |
| | Tugela Ferry WTP (raw water) | uThukela River | Tugela Ferry WTP | 0.4 | 315 | uPVC | 7.8 | 15 |

*Personal Communication: Area Engineer, Ardeep Munessar, uMzinyathi DM staff (May 2020)

13.3.2 Status Quo and Limitations of the Upper uThukela System

(a) Ezakheni Water Treatment Plant and Supply System

Metered water sales commenced in January 2019 and a comprehensive trend analysis has been prepared with the data collected to date (**Figure 13.72**). The water sales captured for October 2019 – March 2020 is presented in **Table 13.83**. It is shown in **Table 13.83** and **Figure 13.72** that the total sales from Ezakheni WTP in October and November 2020 exceeded the design capacity of 32 Mℓ/day (**Section 13.3.1 (b)**). **Table 13.83** shows that the average production over the last six months was 30.577 Mℓ/day.

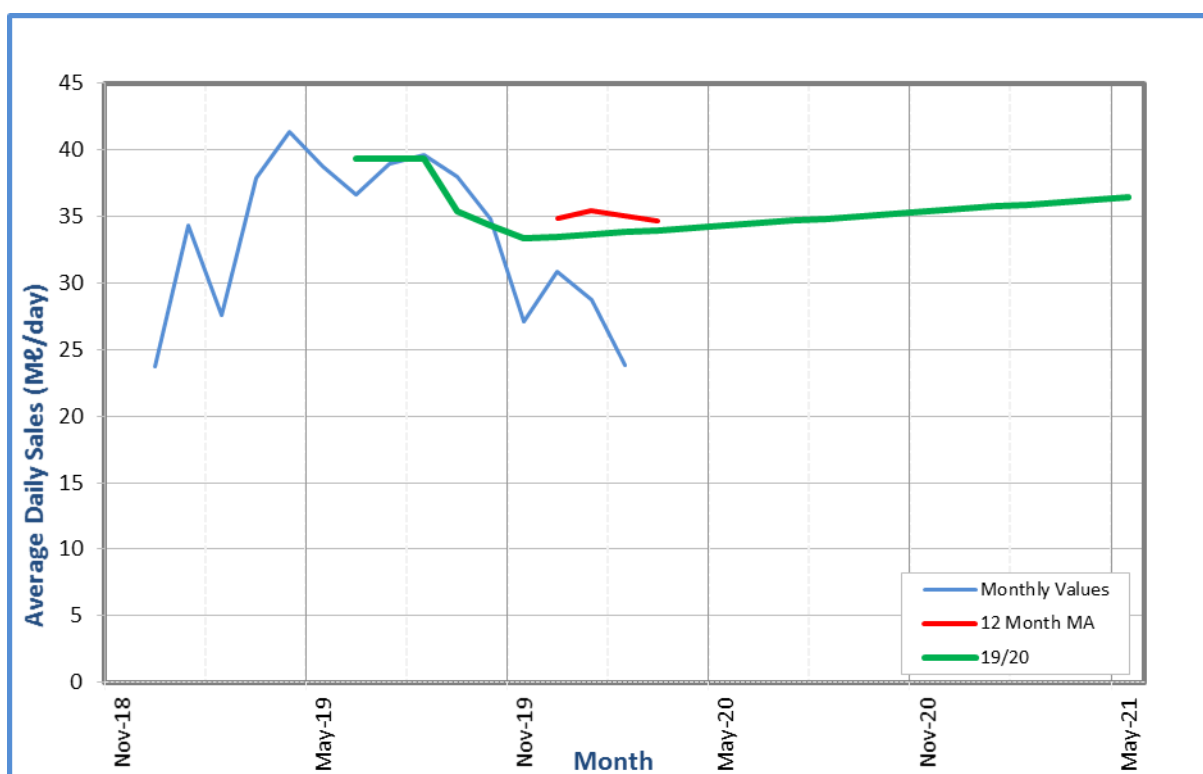

Figure 13.72 Water Demand from Ezakheni WTP

Table 13.83 Ezakheni WTP metered water sales for October 2020 – March 2020 (Umgeni Water 2020: spreadsheet).

| Meter Description | Oct 2019 (Mℓ/day) | Nov 2019 (Mℓ/day) | Dec 2019 (Mℓ/day) | Jan 2020 (Mℓ/day) | Feb 2020 (Mℓ/day) | Mar 2020 (Mℓ/day) |
|---|-------------------|-------------------|-------------------|-------------------|-------------------|-------------------|
| Aasvoëlkop Reservoir Outlet | 22.446 | 19.453 | 17.210 | 14.318 | 13.911 | 11.558 |
| Abattoir Hill Reservoir Outlet to Ithala Reservoir | 2.363 | 2.174 | 2.450 | 1.891 | 2.339 | 2.090 |
| Abattoir Hill Reservoir to Maidens Castle Reservoir | 13.112 | 13.127 | 11.294 | 10.843 | 12.474 | 10.175 |
| Ezakheni WTP Local | 0.040 | 0.041 | 0.037 | 0.040 | 0.037 | 0.039 |
| Total Ezakheni | 37.961 | 34.795 | 30.991 | 27.092 | 28.760 | 23.861 |

The Umgeni Water Ezakheni Water Loss Investigation (November 2018), the Umgeni Water 2017 Process Audit (July 2017) and the Umgeni Water 2019 Process Audit (April 2019) identified significant water leaks at the raw water pump station, on the WTP and the bulk and reticulation pipelines. Therefore, real losses are currently contributing significantly to the metered water sales. Umgeni Water is currently implementing a maintenance programme to address the high water loss resulting from the ageing infrastructure and previous minimal maintenance. The programme was not particularly successful in reducing the losses as the prevailing theft of water has persisted, and some water infrastructure is in need of replacement. The WSA should take a policy decision should on how to deal with unauthorised connections.

It is shown in **Table 13.84**, **Table 13.85**, and **Table 13.86** that a complete and comprehensive water balance could not be determined in the Ezakheni Water Loss Investigation as the majority of the meters were not operational(November 2018). **Figure 13.72** shows a significant decline in production over the last few months leading up to March 2020. This can be attributed to the plant being affected by lightning strikes, load shedding and problems with the abstraction pumps (all of which are soon to be replaced by Umgeni Water). It can be seen from the 12 month monthly average (production) in **Figure 13.72** that the WTP is currently capable of meeting the forecasted demands of 2021.

Table 13.84 Ezakheni WTP inlet meters (Umgeni Water 2018: 13).

| Description of the Meter | Meter Flowrate (m ³ /hr)* | Strap-On Meter Flowrate (m ³ /hr)** |
|--------------------------------|--------------------------------------|--|
| 600 mm Plant Inflow (Meter 01) | 467.9 | Could not measure |
| 400 mm Plant Inflow (Meter 02) | 501.49 | Could not measure |

*Confirmed by UW Operations (Linda Vezi) on 31 March 2020

**Umgeni Water 2018:13

Table 13.85 Ezakheni WTP outlet/pump station meters (Umgeni Water 2018: 13).

| Description of the Meter | Meter Flowrate (m ³ /hr) | Strap-On Meter Flowrate (m ³ /hr) |
|-----------------------------------|-------------------------------------|--|
| Aasvoëlkop new pipeline (500 dia) | 0 (meter not working)* | 630 |
| Aasvoëlkop old pipeline (400 dia) | 0 (meter not working)* | 331 |
| Abattoir pipeline | 738.26* | 621 |

*Confirmed by UW Operations (Linda Vezi) on 31 March 2020

Table 13.86 Aasvoëlkop Command Reservoir outlet

| Description of the Meter | Meter Flowrate (m ³ /hr) | Strap-On Meter Flowrate (m ³ /hr) |
|-----------------------------|-------------------------------------|--|
| Aasvoëlkop Reservoir outlet | 693.7* | 0 |

*Confirmed by UW Operations (Linda Vezi) on 31 March 2020

The Ezakheni WTP is operating above design capacity. This is as a result of growth in water demand in the Ezakheni area, the addition of the Driefontein and Matiwanaskop areas to this supply node and, most notably, the high water losses in the supply system.

It is not sound operating practice to continuously operate the WTP at or above full capacity as it prevents and impedes scheduled maintenance on the filters, clarifiers and auxiliary equipment. The

output of the plant was reduced in early 2019 in an effort to improve and maintain the water quality, and so that necessary repairs and maintenance could be undertaken.

(b) Tugela Estates Water Treatment Plant and Supply System

Metered water sales commenced in January 2019 and a comprehensive trend analysis has been prepared with the data collected to date (Figure 13.73). The water sales captured for October 2019 – March 2020 is shown in Table 13.87. It can be deduced from Table 13.87 that the average production over the last six months was 0.397 Mℓ/day. This is due to operational challenges and breakdowns within the WTW, abstractions and high lift pump stations⁵⁷.

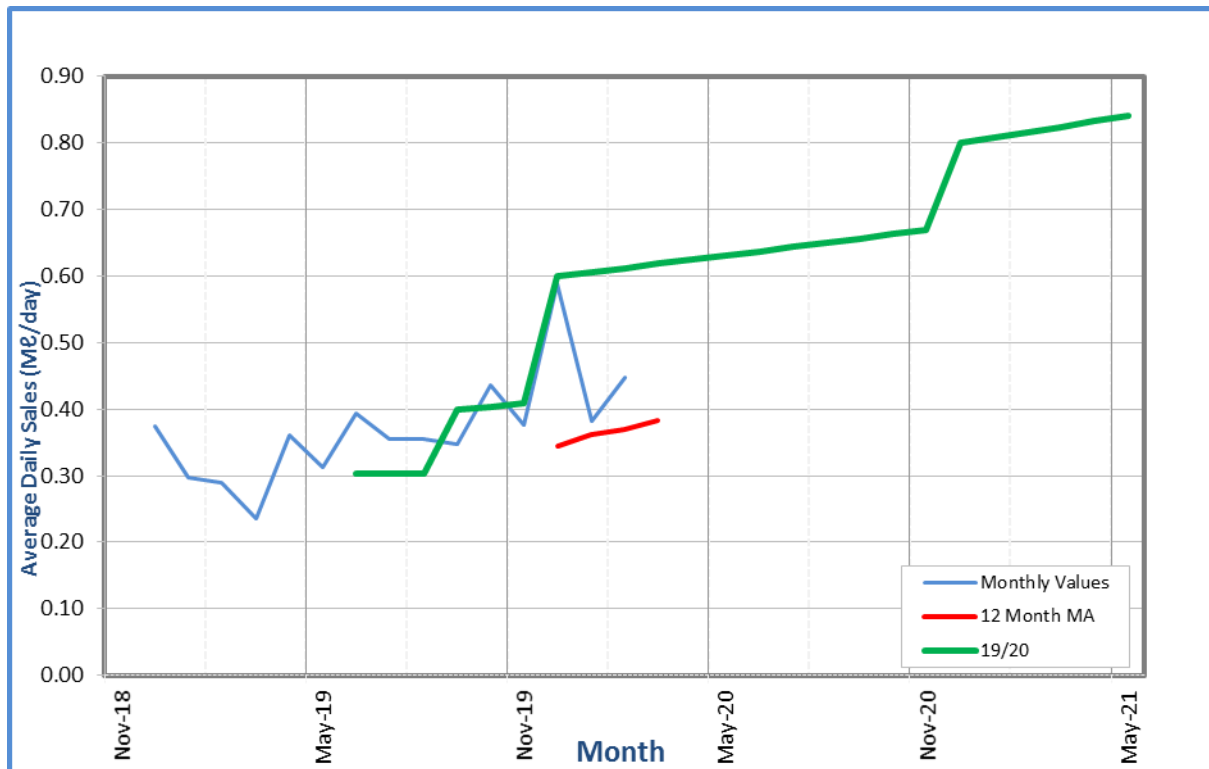

Figure 13.73 Water Demand from Tugela Estates WTP

⁵⁷Confirmed by UW Operations (Moses Sibeko), North West Region, 31 March 2020

**Table 13.87 Tugela Estates WTP metered water sales for October 2020 – March 2020
(Umgeni Water 2020: spreadsheet).**

| Meter Description | Oct 2019 (Mℓ/day) | Nov 2019 (Mℓ/day) | Dec 2019 (Mℓ/day) | Jan 2020 (Mℓ/day) | Feb 2020 (Mℓ/day) | Mar 2020 (Mℓ/day) |
|----------------------------------|----------------------|----------------------|----------------------|----------------------|----------------------|----------------------|
| Sahlumbe Reservoir Outlet | 0.095 | 0.236 | 0.188 | 0.184 | 0.087 | 0.152 |
| Khokhwana Reservoir Outlet | 0.053 | 0.004 | 0.090 | 0.171 | 0.132 | 0.131 |
| Mhlumayo Reservoir Outlet | 0.020 | 0.184 | 0.143 | 0.151 | 0.144 | 0.144 |
| Hlonyana Galaxy Reservoir Outlet | 0.003 | 0.012 | 0.009 | 0.011 | 0.020 | 0.020 |
| Total Tugela Estates | 0.171 | 0.436 | 0.431 | 0.516 | 0.383 | 0.448 |

The UAP Phase 2 however reported that the Tugela Estates WTP operates at the full capacity of 1.2 Mℓ/day (2016: 81) and that this was a result of growth in the area and systems designed for standpipe connections having illegal yard and house connections. Umgeni Water Operations have further indicated that the Tugela Estates WTP currently (April 2020) provides water by utilising a scheduled “water shedding” operational philosophy. The discrepancy between the results presented in **Figure 13.73** for the Tugela Estates WTP and the information reported by Umgeni Water Operations and the UAP Phase 2 Study may be attributed to the following:

- The Umgeni Water Process Audits (2017 and 2019) identified numerous water leaks at the Tugela Estates WTP. Umgeni Water has repaired/installed new meters at the reservoir outlets, however meters still need to be installed at the reservoir inlets, the raw water pump station and at the inlet and outlet of the WTP. A comprehensive water balance therefore cannot currently be undertaken to quantify the water losses and confirm the contribution of the water losses to the discrepancy.
- The static pressure requirement of the Kokwane pumps at the Tugela Estates WTP is 260 m, however, the head of the pumps is designed at 250 m. Umgeni Water (UW) Operations has confirmed this results in a “trickle” flow into the Kokwane Reservoir and this could be resulting in the low metered water sales. UW Operations are currently (March 2020) in the process of procuring new pumps that will address this issue.

The UAP Phase 2 reported that the uMhlumayo Borehole Scheme was not operational in November 2015 (2016: 49). The scheme was operational in January and February 2019 (**Table 13.87**) but not in March – April 2019 as a result of a pump motor that had burnt out. This motor has since been replaced and full water supply has resumed.

The uMhlumayo Borehole Scheme area is growing exponentially and this will impact on the ability of the supply system to maintain the meet the required water demand. The high lift of the pumps could

be problematic during pump trips and will result in high surge pressures, resulting in pipe damage and bursts.

A water loss investigation at the Tugela Estates WTP was undertaken in May 2019 and identified significant water leaks at the pump stations, within the WTP and both the bulk and reticulation pipelines. UW is in the process of addressing the leaks on the bulk infrastructure, and the uThukela DM has been sensitised to the real losses being experienced within the reticulation. Umgeni Water is currently busy with interventions on the Tugela Estates WTP and uMhlumayo Borehole Scheme (including new production boreholes), such the plant could meet the forecasted demands of 2021.

(c) Olifantskop Water Treatment Plant and Supply System

Metered water sales commenced in January 2019 and a comprehensive trend analysis has been prepared with the data collected to date. The water sales captured for October 2019 – March 2020 are shown in **Table 13.88** and **Figure 13.74**. It can be deduced from the **Table 13.88** that the average production over the last six months was 4.953Mℓ/day.

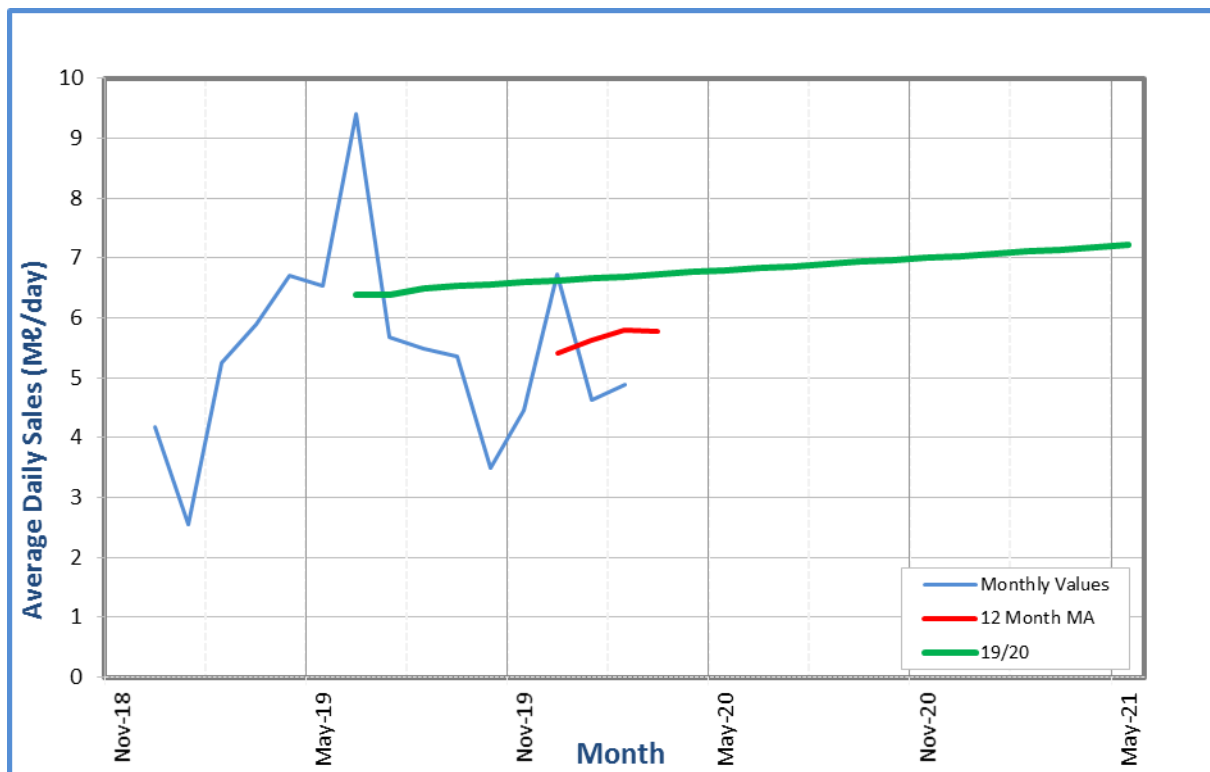

Figure 13.74 Water Demand from Olifantskop WTP

Table 13.88 Olifantskop WTP metered water sales for October 2019 – March 2020 (Umgeni Water 2020: spreadsheet).

| Meter Description | Oct 2019 (Mℓ/day) | Nov 2019 (Mℓ/day) | Dec 2019 (Mℓ/day) | Jan 2020 (Mℓ/day) | Feb 2020 (Mℓ/day) | Mar 2020 (Mℓ/day) |
|---|-------------------|-------------------|-------------------|-------------------|-------------------|-------------------|
| Petronella Reservoir Outlet to Ekuvukeni | 4.397 | 2.653 | 4.034 | 4.941 | 4.141 | 3.961 |
| Petronella Reservoir Outlet to Waaihoek | 0.771 | 0.644 | 0.799 | 0.660 | 0.589 | 0.785 |
| Pump Station Outside Olifantskop WTP to Mabhekazi | 0.156 | 0.129 | 0.135 | 0.170 | 0.146 | 0.123 |
| Olifantskop WTP Local | 0.035 | 0.059 | 0.137 | 0.141 | 0.083 | 0.028 |
| Total Olifantskop | 5.359 | 3.486 | 5.106 | 5.912 | 4.959 | 4.897 |

The stochastic yields for the Olifantskop Dam at the recurrence intervals of 1 : 50 years and 1 : 100 years were presented in **Table 13.17**. A comparison of **Table 13.17** and **Table 13.88** shows that the volumes of water supply from Olifantskop WTP as recorded in October 2019 – March 2020 was only supplied at the 98% and 99% assurance of supply in November 2019. The stochastic yield for the “domestic water supply criteria of 95% assurance of supply (failure 1 : 20 years) (DWA 2012: 24) is listed in **Table 13.89**. A comparison of **Table 13.89** and **Table 13.90** identifies that it was only in November 2019 that the volume of water was supplied at the 95% assurance of supply (failure 1 : 20 years).

Table 13.89 Long-term stochastic yields from Olifantskop Dam (DWA 2012: 24).

| Scenario | Historical Firm Yield (million m ³ /annum) (RI ^a : years) | Calculated Supply (million m ³ /annum) (RI ^a : years) | Stochastic Yields (million m ³ /annum) | | | |
|--|---|---|---|--------------|---------------|-----------------|
| | | | 95% (1 : 20) | 98% (1 : 50) | 99% (1 : 100) | 99.5% (1 : 200) |
| Olifantskop Dam – 0.2175 million m ³ (Assumption of 85% Siltation) ^b | 1.10 (> 1 : 200) | 2.45 ^c (1 : 1) | 1.52 | 1.39 | 1.30 | 1.22 |
| Olifantskop Dam – 1.45 million m ³ (Original Estimated Capacity) ^d | 3.34 (> 1 : 200) | 2.45 ^c (> 1 : 200) | 4.05 | 3.72 | 3.5 | 3.36 |

^a RI = recurrence interval.

^b Calculation based on DWA 2012: 17 (15% of 1.45 million m³).

^c DWA 2012: 6

^d DWA 2012: 17.

Table 13.90 Summary of Olifantskop WTP metered consumption for January – April 2019 (after Umgeni Water 2019: spreadsheet).

| Olifantskop WTP Metered Consumption | Oct 2019 (Ml/day) | Nov 2019 (Ml/day) | Dec 2019 (Ml/day) | Jan 2020 (Ml/day) | Feb 2020 (Ml/day) | Mar 2020 (Ml/day) |
|---|-------------------|-------------------|-------------------|-------------------|-------------------|-------------------|
| Total metered consumption (Ml/day) | 5.359 | 3.486 | 5.106 | 5.912 | 4.959 | 4.897 |
| Total metered consumption (million m ³ /annum) | 1.956 | 1.272 | 1.864 | 2.158 | 1.810 | 1.787 |

The metered water consumption, whilst at the time of this report (March 2020) is of a relatively short duration, supports the findings of the DWA 2012 study which noted:

- “Even at a low recurrence interval of 1 : 20 years the yield of the Olifantskop Dam is not sufficient to supply the users within the supply area and therefore the resource also places a constraint on the supply of water.
- The current volume of water supplied from the Olifantskop WTP is supplied at a very low recurrence interval of 1 : 1 or a failure every year. This is much less than even the lower end of domestic water supply criteria of 95% assurance of supply (failure 1 : 20 years) and poses a very high risk which confirms the regular shortages currently experienced.”

(DWA 2012: 24)

The Olifantskop WTP has no functional raw water or clear water flow meters within the plant and therefore the capacity of 10 Ml/day cannot be confirmed. Staff at the plant state that the plant has never been able to consistently produce in excess of 8 Ml/day⁵⁸. The Ekuvukeni WTP has not been able to operate at its capacity of 8 Ml/day over the past two years, except for June 2019 as can be seen in **Figure 13.74**. This is as a result of the ongoing refurbishment of the WTP (since March 2019), and the desilting of the dam (as the turbidity of the raw water was increased, during that process).

The DWA 2012 report and the Umgeni Water 2017 and 2019 Process Audits noted significant water leaks. This is similar to the Ezakheni WTP (**Section 13.3.2 (a)**) and the Tugela Estates WTP (**Section 13.3.2 (b)**) and although Umgeni Water has installed sales meters at the respective reservoir outlets, meters at the raw water and inlet meters still need to be installed. This means that a comprehensive water balance cannot currently be undertaken. A water loss investigation at the Olifantskop WTP was undertaken in May 2019 by UW and identified significant water leaks at the pump stations, within the WTP and both the bulk and reticulation pipelines. UW is in the process of addressing the leaks on the bulk infrastructure, and the uThukela DM has been sensitised to the real losses being experienced within the reticulation.

The Umgeni Water 2017 Process Audit recorded the turbidity values listed in **Table 13.91** and explained as follows:

“On the day of the audit (26 June 2017), the turbidity at the clarifiers and filters was above the recommended guidelines of 5 NTU and 1 NTU respectively, resulting in a final water turbidity of

⁵⁸ Personal communication, Yovesh Danilala & Moses Sibeko (ex-uThukela DM) Operations, UW, North West Region (20 March 2020)

7.40 NTU. This exceeds SANS 241: 2015 operational and the aesthetic limit of 1 NTU and 5 NTU respectively.”

(Umgeni Water 2017: 11)

Table 13.91 Turbidity recorded in the Olifantskop water treatment process on 26 June 2017 (Umgeni Water 2017: 10).

| Sample | Value |
|--------------------------|----------|
| Raw Water | 141 NTU |
| Combined Clarified Water | 10.4 NTU |
| Combined Filtrate | 5.58 NTU |
| Final Water | 7.40 NTU |

The Umgeni Water 2019 Process Audit repeated the findings on the water turbidity exceeding the SANS 241: 2015 limits (2019: 6). The highly turbid water as noted by the Umgeni Water 2017 and 2019 Process Audits informs the operating philosophy of the raw water pumps as explained by the 2012 DWA report as follows:

“... water taken from the Olifantskop Dam is often highly turbid (contains suspended fine silts) and takes longer to treat, reducing the throughput of the WTP. Therefore, when a single raw water pump is turned on, flowing water at the inlet appears to stir up and suspend sediment, contaminating the raw water. This situation is even worsened when the second raw water pump is turned on, due to the increased water velocity at the inlet. As a result, the raw water pump station is operated with *only one of three pumps at a time*, thus theoretically a maximum of 8.64 ML/day (3.15 million m³/annum) of water can be pumped to the WTP. The other significant problem at the abstraction is that if more than one pump is switched on, the electricity supply trips. This is possibly due to a number of issues, including the heavy silt content of the water being pumped.”

(DWA 2012: 5)

An update on the above statement is as follows: The plant is able to run more than one raw water pump simultaneously (no electrical issue or trips), however, the plant is not able to cope with the increased volume of two pumps operating in parallel due to the high silt/solids content of the incoming raw water. The plant is, therefore, operated with a single duty pump, as this provides 8 ML/day of raw water, which is the typical volume that the plant could treat in a day.

13.4 Water Balance/Availability

13.4.1 Upper uThukela Region

The DWA Reconciliation Strategies for the Colenso Water Supply Scheme (DWA 2011(a): 27), the Ezakheni Water Supply Scheme (DWA 2011(b): 29), the Ladysmith Water Supply Scheme (DWA 2011(c): 25) and the Bergville Water Supply Scheme (DWA 2011(c): 28) identified that *there will be insufficient water to meet the future water demands of these supply areas*. The hydrology of the Upper uThukela Region has to be updated (the last hydrological assessment was undertaken in 2004 as part of the Thukela ISP) and as identified in **Section 13.3.2**, the installation of meters at the relevant WTPs must be completed so that a complete water demand assessment may be undertaken. A comprehensive water balance can then be determined using the updated hydrology and water demand assessment. DWS has initiated the water resources study of the region in 2020, this will be useful in reviewing the water balance. Progress on this will be reported in the next IMP (2021).

13.4.2 Sundays Region

The water balance determined by DWS for the Olifantskop Dam/Ekuvukeni Water Supply system is shown in **Figure 13.75**. As discussed in **Section 13.3.2 (c)** and shown in **Figure 13.75**, there is insufficient water resource to meet the existing and future demands.

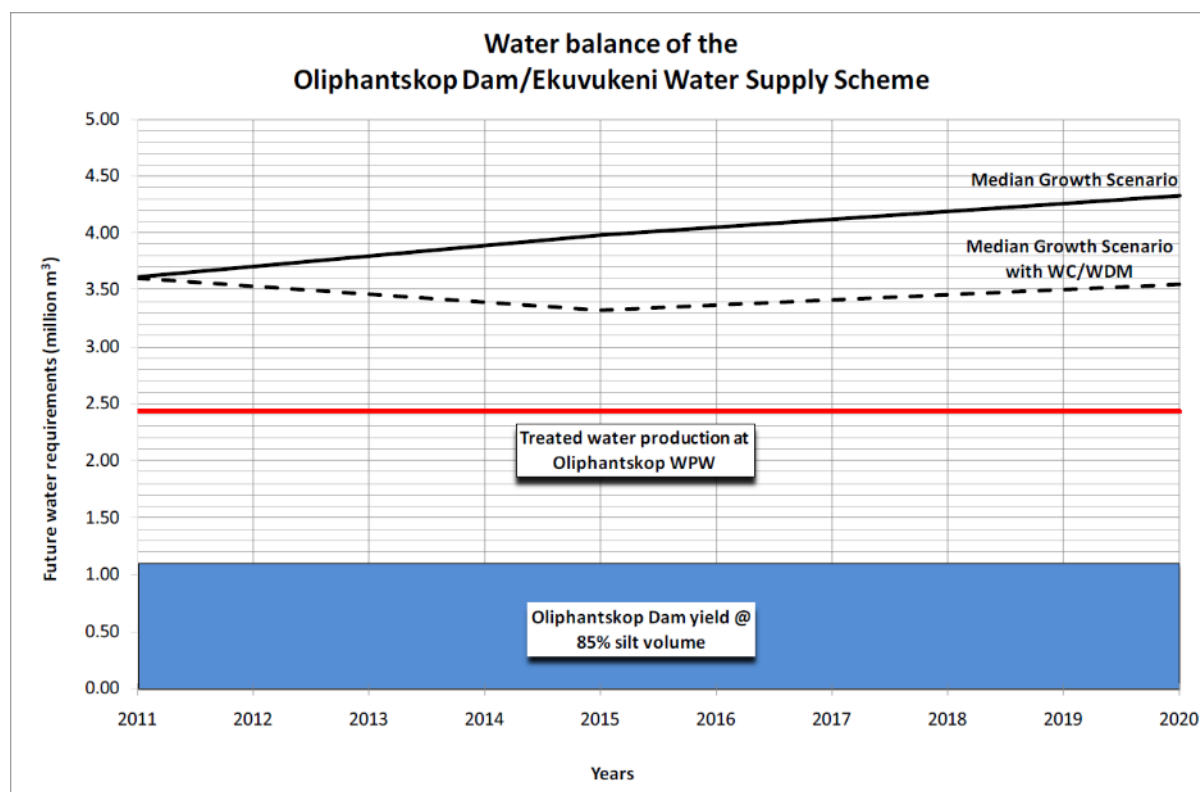

Figure 13.75 Water balance for the Olifantskop Dam/Ekuvukeni Water Supply Scheme (DWA 2012: 21).

Similar to the Upper uThukela Region, the hydrology of the Sundays Region needs to be updated and a water demand assessment undertaken after the installation of the required meters so that the water balance can also be updated.

13.4.3 Bushmans Region

The DWA Reconciliation Strategy Studies for the Weenen Water Supply Scheme (DWA 2011(h): 32), and the Estcourt Water Supply Scheme (DWA 2011(g): 34) identified that *there will be sufficient water to meet the future water demands of these supply areas (from the Bushmans River and Wagendrift Dam)*. The hydrology of the uThukela Region (including the Sundays Region) should be updated (the last hydrological assessment was undertaken in 2004 as part of the Thukela ISP) and as recommended in **Section 13.3.2**, the installation of meters at the relevant WTPs must be completed so that a complete water demand assessment may be undertaken. A comprehensive water balance can then be determined using the updated hydrology and water demand assessment. DWS is procuring a contract to undertake a water resources study of the region (uThukela Water Management Area) in 2020 and this will be useful in updating the water balance. Progress on this will be reported in the next IMP (2021). The water balance, undertaken by DWS, for both the Weenen Water Supply System and

the Estcourt Water Supply System is shown in **Figure 13.76** and **Figure 13.77** respectively. As discussed, and as shown in **Figure 13.76** and **Figure 13.77**, there is sufficient water resource to meet the existing and future demands.

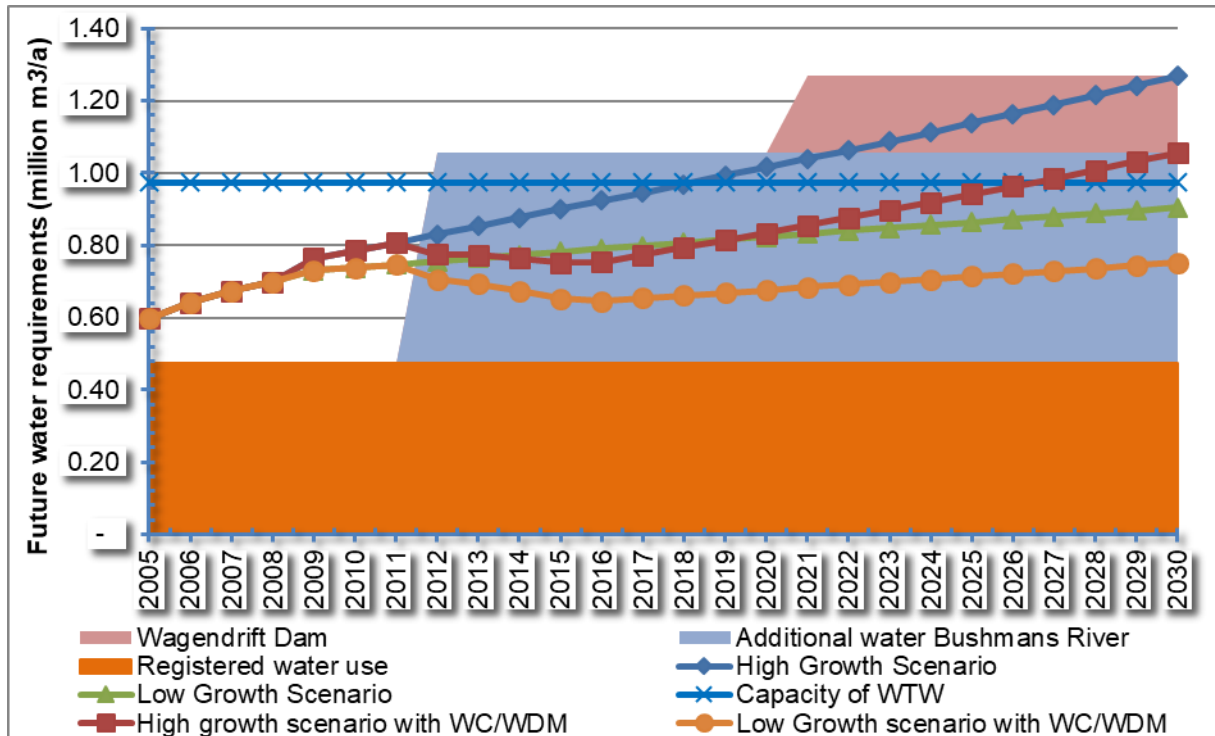

Figure 13.76 Water Reconciliation options to meet water requirements for Weenen Water Supply Scheme (DWS 2011: 32)

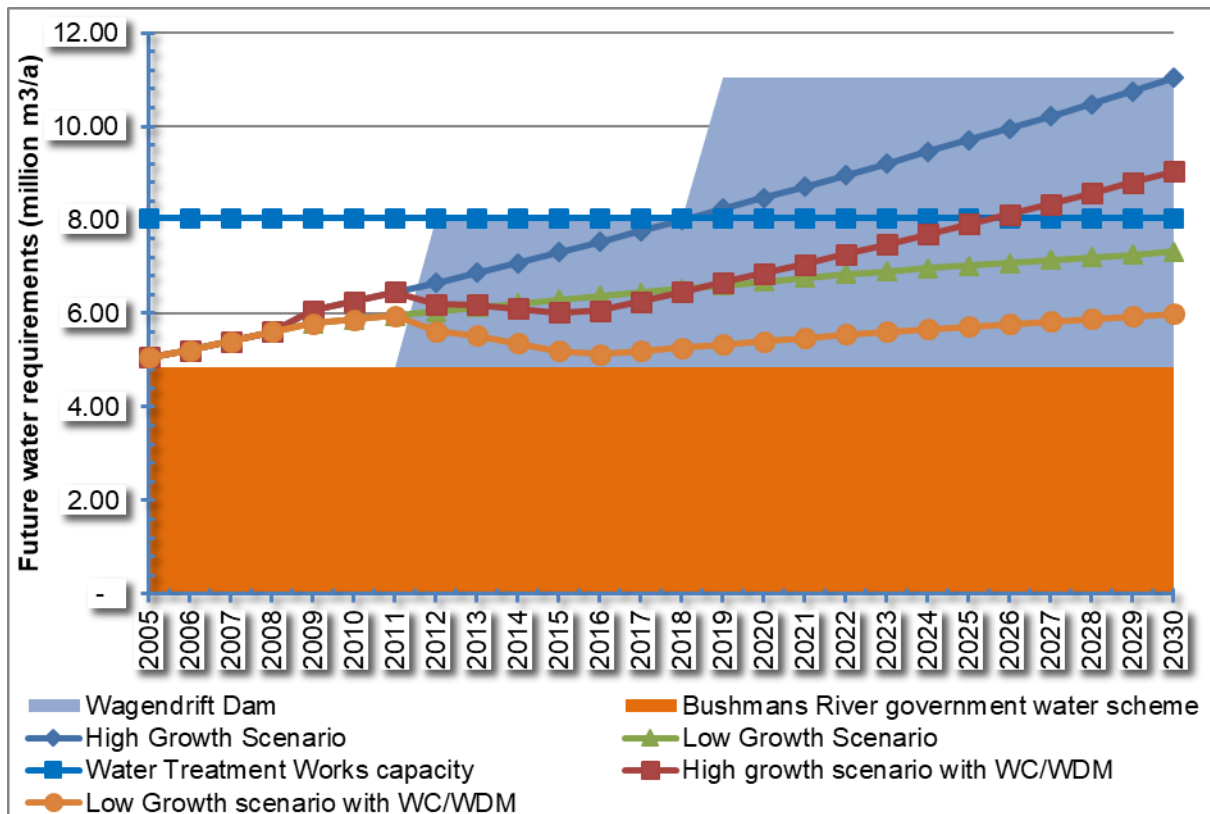

Figure 13.77 Water Reconciliation options to meet water requirements for Weenen Water Supply Scheme (DWS 2011: 35)

13.5 Recommendations for the Upper uThukela System

13.5.1 Explanatory Note

The National Water and Sanitation Master Plan (Section 2.5 in Volume 1) summarises the relationship between asset maintenance planning and infrastructure planning in Figure 13.78.

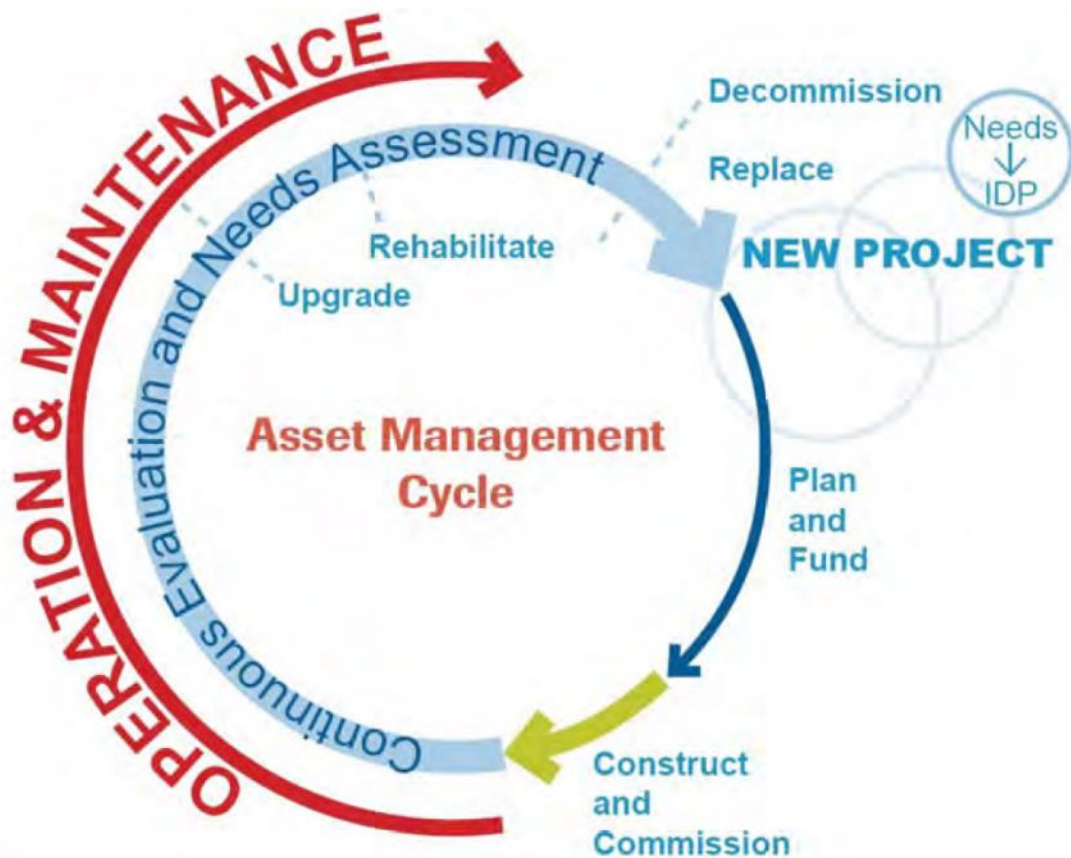

Figure 13.78 Integrated asset management (DWS 2018: 5-14).

The Umgeni Water IMP (Volumes 2, 3, 4, 5 and 7) conventionally discusses the “continuous evaluation and needs assessment that informs new projects and upgrades” as shown in **Figure 13.78**. However, as discussed in **Section 13.3.2**, there are currently significant gaps as a result of poor maintenance over the past few years and Umgeni Water is now trying to address these challenges. There is an urgent need to prioritise proper operation and maintenance (O&M) in the district after years of focus primarily on new capital works. The UTDM faces a backlog in O&M needs, and it would be safe to say that no schemes meet the DWS “reliability test” and, as a result, would probably be considered as service backlog.

The municipality updates the asset register periodically, but should be develop further into a daily utilized asset management system. It is understood that the uTDM has the Infrastructure Management Query Statement (IMQS) system installed at their offices. However, this comprehensive infrastructure asset lifecycle management solution is, unfortunately, not being used by the DM. This should be prioritized, with all new infrastructure information from the asset register, the GIS, and new projects being inputted into the system; all maintenance tasks prioritized and reported on in the system; and in general the entire asset base and its operations being run through the IMQS. This system allows for the seamless integration between the “financial” asset register, and the technical daily management and planning for the entire asset base, not just the water and sanitation. By utilizing the IMQS, the municipality will more easily be able to prioritise budget for O&M.

The O&M Plans of the uTDM must detail the O&M standards, policies and procedures so that all schemes are handled in the same manner, and all consultants/contractors involved in projects understand the requirements on their side prior to project commissioning.

If Umgeni Water is contracted to own, operate and maintain the regional bulk infrastructure throughout uTDM (currently operating 3 WTWs only – in Alfred Duma LM), this will result in a very different future O&M Plan in the uTDM. In effect, it will mean that there is no significant change of scope in the future, but instead, the currently planned regional projects will not be the responsibility of the uTDM. Instead, the uTDM will focus on the O&M of the reticulation networks, revenue collection, package treatment works, and the smaller stand-alone schemes. This may be a favourable option for the uTDM, as it will allow for a focus on delivering quality services to the customer, and leave the specialized function of bulk services to a sector leader, Umgeni Water.

It is anticipated that in the coming year (2020/2021), as Umgeni Water implements the urgent maintenance activities and continues with data collection, that there will be better information to inform a full needs assessment so that upgrades and new projects can be identified. The Recommendations section will therefore contain more detail in the next version of the IMP.

13.5.2 System Components

(a) Upper uThukela Region

DWS, in 2018, undertook a preliminary assessment of water availability in the uThukela catchment and concluded that:

“all available water (including Spioenkop Dam) has been allocated and it is evident that alternative options need to be considered to make more water available for the competing water users in the uThukela River System.”

(DWS 2018: 5 – 6)

The DWS 2018 assessment noted that “investigations should consider both short and long-term augmentation solutions while making sure all competing water needs, in and outside the uThukela River System, are taken into consideration” (DWS 2018: 10). This assessment identified the following recommendations. Comments made during a meeting with DWS and Umgeni Water subsequent to this report are shown in blue:

- i. *“The hydrology and the yield analysis of the Thukela River System should be updated. Such an update should be preceded by a catchment wide water validation study to ensure that the water use information is at a high level of integrity and resolution. These requirements are prerequisite for developing reliable hydrological data that can provide coherent water resource planning and management decision support information” (DWS 2018: 10). (This was agreed between DWS and Umgeni Water. DWS has initiated the water resources study of the region in 2020; this will be useful in reviewing the water balance. Progress on this will be reported in the next IMP (2021).*
- ii. *Water conservation and water demand management to be implemented to reduce losses. This will entail:*
 - *“Undertake an assessment of the current water loss situation in the Target Area with the aim to define water loss saving targets.*
 - *Identify what further measures should be implemented and update the Water Conservation/Water Demand Management (WC/WDM) plans accordingly.*

- Identify funding arrangements to implement the WC/WDM measures in accordance with a prioritised list.
- Undertake a continuous monitoring of the water supply system balance using the standard methods.”
- *(It was agreed that the above bullets would be the best short and medium term interventions to provide additional resource to the consumers).*

(DWS 2018: 7)

Water conservation and water demand management (WCWDM) was listed as the top priority in all the DWS Reconciliation Strategies for the uThukela DM (UTDM) area. This has not changed, and UW view this as the **TOP** priority for UTDM to implement with urgency. Considering the very high-water losses and even higher non-revenue water, the UTDM cannot afford to continue with new capital works, without also replacing old asbestos concrete (AC) pipes, resolving illegal connections, and metering all customers with individual connections. Bulk metering is also a key priority in order to be able to calculate the water balance in each scheme. It should also be remembered that the water demand model utilised for the UTDM master plan includes the assumption that water losses percentage will decrease over time, as it plans for good business, not poor management. If the municipality does not intervene, and reduce water losses, the demands predicted for the various schemes may be insufficient.

In the longer term, as the service landscape changes, the UTDM should move out of the current crisis management to a pro-active WCWDM programme that includes:

- Water Resource Management
- Distribution Management
- Consumer Demand Management
- Return Flow Management

An aggressive, expanding WCWDM project should be planned for each scheme, and the additional resources required for the new schemes and in the preparation for schemes migrating to a higher level of service. A dedicated WCWDM team is not needed. Instead, the reticulation operations teams, and the maintenance teams need to have WCWDM key performance indicators (KPIs); with maintenance schedules that ensure coverage at all schemes. This needs to be coupled with a strong consumer awareness programme, and the implementation of a “citizen science” reporting mechanism to report leaks, bursts etc. This system should be implemented immediately as “part of business as usual”, by the UTDM staff. A 5-year non-revenue water (NRW) reduction plan was developed for the UTDM by JOAT Consultants through support of Umgeni Water (UW), DWS and CoGTA KZN. This is an intense programme dealing with the highest priority interventions. Due to the significant backlog of problems, and the urgent nature thereof, this should be a set of outsourced projects to make a rapid, significant impact on NRW in the UTDM.

A significant aspect that is not dealt with in the NRW Master Plan is asbestos concrete (AC) pipe replacement in the older areas of the established towns. This ageing infrastructure is a significant contributor to the water losses in these towns and a prioritized programme of replacement should be developed and implemented as a matter of urgency.

iii. *Investigate the feasibility of the following potential augmentation options:*

Utilise the uThukela Water Project (uTWP) (Figure 13.79): One viable augmentation option for the freeing up/increased available yield in the Upper uThukela is the uTWP. The uTWP could be implemented in phases although DWs would have to negotiate this with the Vaal system. It is envisaged that all components of the uTWP would be constructed over a period of about 8 to 10 years. The aim of the uTWP is to increase the delivery rate of raw water to the Vaal river scheme (VRS), via the Drakensberg Pumped Storage Scheme, by 15 m³/s. Depending on operating regimes, this could

add up to 450 million m³ of additional water being transferred per annum. The estimated capital and compensation costs (excluding financing and operating costs) for the uTWP amount to just less than R5 billion in March 1998 terms.

The following main elements of infrastructure would be required in the scheme:

- Jana Dam on the uThukela River situated approximately 30 km south-west of Ladysmith and 15 km downstream of the confluence of the uThukela and Klip Rivers.
- Mielietuin Dam on the Bushman's River, situated between Weenen and Estcourt, and immediately upstream of the western boundary of the Weenen Nature Reserve.
- 120 km of pipeline aqueduct linking the proposed dams to the existing Kilburn Dam at the foot of the Drakensberg Pumped Storage Scheme

Recommendation: DWS to Investigate options to develop the uTWP in phases with the aim to expedite water provision to the Target Area over the medium term. This would assist in freeing up available raw water in the Upper uThukela for abstraction by uTDM for Okhahlamba, Inkosi Langalibalele and Alfred Duma LM. This option, therefore, focuses on the trading of water use entitlements, based on the uTWP being constructed. Funding should only be allocated to this project upon the completion of a detailed feasibility study by DWS (to investigate options to develop the uTWP in phases).

Utilise groundwater resources, including the silted up Windsor Dam, located close to Ladysmith: The Windsor Dam is on the Klip River, and is close to Ladysmith. The Klip River is one of the primary water resources for the Ladysmith WTW (the other being the Spioenkop on the uThukela River). The rationale is that greater (and more reliable) abstraction from the Klip River would free up available raw water on the Upper uThukela River for abstraction by UTDM for Okhahlamba LM settlements. This option therefore focuses on the trading of water use entitlements by promoting conjunctive use. The Windsor dam is heavily silted, and this reduces the actual storage capacity of the dam. The desilting of a dam is a specialised and costly operation and is often found not to be viable in comparison to other augmentation options for the particular water system. The option of desilting is therefore not immediately recommended, although, a uTDM study could be undertaken to prove if this is the case.

Moving forward, the area of Windsor Dam and Ladysmith is seen to have relatively satisfactory/good groundwater potential. Groundwater extractions could reduce the current surface water abstractions from Spioenkop Dam and the Klip River. Another untapped source/potential is to abstract from the silted Windsor Dam by use of slotted pipes and concrete sumps. The recommendation regarding Windsor Dam is, therefore:

- Review the groundwater utilisation and availability in areas that were recommended sources (in the **DWAF, 1998** study) and undertake desktop investigations to confirm groundwater potential and availability. Estimated cost for this study: R1 million.
- Consider the commissioning of higher intensity investigations where the potential for groundwater development is shown to be feasible (geohydrological study using specialised equipment, in and around the Windsor Dam). Estimated cost for this study: R1.5 million. No borehole drilling should be undertaken before the conclusion of these studies.
- Investigate the potential for installation of slotted pipes draining into concrete sumps within the Windsor Dam in order to further improve abstraction of subsurface water. Estimated cost for this study: R1 million.
 - Groundwater: Furthermore, UW have communicated with the uTDM in regard to the most practical interventions for the short term, and received the following information. It includes the refurbishment of existing boreholes (hand pump and production boreholes),

and the drilling and equipping of new boreholes (hand pump and production boreholes). Whilst UW agree that the groundwater potential of UTDM is generally satisfactory to good, it is strongly advised that due diligence be carried out prior to drilling i.e. geohydrologists to first conduct comprehensive geohydrological surveys before contractors are commissioned to drill. The geohydrologists will also assist with proper siting of boreholes and provisional indications of expected groundwater quality. This will minimize the possible wasted drilling of low yielding boreholes.

- The geohydrologist should also consider existing boreholes in the study areas of Okhahlamba LM that will serve as indicator boreholes (indicative yield and water quality).
- UTDM has already begun the refurbishment of existing boreholes (hand pump and production boreholes), and the drilling and equipping of new boreholes (hand pump and production boreholes), using drought funding that was transferred to them in March 2019. Spring protections will also be undertaken.

Raise the existing flood attenuation Qedusizi Dam: The Qedusizi Dam was not constructed for water supply purposes (as opposed to most conventional dams). This dam was primarily constructed for flood attenuation. In the report, Alternative Sources of Water Supply to Ladysmith/Emnambithi Area (DWAF, 1998), it was concluded that: ‘The provision of storage in Qedusizi Dam to supply the study area will, from a water utilisation point of view, be inefficient. A loss of 22 x 106 m³/annum in net yield due to evaporation and spills occurs when Qedusizi Dam is used as a storage dam.’

Recommendations: Review the DWA, 1998 study assumptions, in order to determine if there are any aspects of this option that may have changed, and which would improve the efficiency of the Qedusizi Dam as a water storage dam. Due to the lack of depth throughout this dam, UW **do not** propose that this study be undertaken immediately i.e. It is prudent to first pursue all the above mentioned options of this Section 5, as this option of Qedusizi Dam being used as a storage dam has the least merit.

Other recommendations are discussed below:

- Delay full implementation of the ecological water requirements – river releases from dams. *(It is unlikely that this will receive approval from the Department of Environmental Affairs but should be explored).*
- Make water available through trading of water use entitlements *(This will require negotiation with farmers and with the local irrigation boards).*
- Utilise Spring Grove Dam to support the Lower Thukela after augmentation of the uMkhomazi Water Project to free up water from Spioenkop Dam *(This is not possible as the Spring Grove Dam supply has already been accounted for in the yield requirement for the Lower Thukela Bulk Water Supply Scheme).*

Raising of Spioenkop Dam: The option to raise Spioenkop Dam was identified by DWS in order to make more water available for transfer to the Target Area. A cursory assessment of the White Paper X-67’ (DW, 1967) and the Dam Safety Evaluation (DWS, 2015c) of Spioenkop Dam by Mr Johann Enslin (DWS, 2018b) revealed the following: ‘Spioenkop Dam was designed in the late 1960’s and was completed in 1973. **The design makes provision for the Dam to be raised by about 22.23 m in future.** The Dam’s current Full Supply Level (FSL) is 1 070.480 masl, and the Dam’s planned future FSL is 1 092.708 masl.’

A Pre-feasibility (followed by a Detailed Feasibility study) should be undertaken to investigate if the raising of the Spioenkop Dam is a viable solution for water provision to the Target Area and other users. The investigations should commence with a literature review and progressively higher intensity studies while considering the water balance of the entire uThukela River System. Note that these

investigations could form part of a more encompassing Bridging Study of the uThukela Water Project. The rationale is that greater (and more reliable) abstraction from the Spioenkop Dam would free up availability of raw water on the Upper uThukela River for abstraction by uTDM for Okhahlamba LM settlements. The estimated cost for this pre-feasibility study would be R2.5 million and the Detailed Feasibility Study: R 8 million.

A Regional Bulk Water Supply Scheme (RBWSS) for Okhahlamba LM should be developed with the uThukela River as the source, and the proposed bulk WTP positioned in the region of the existing site of the Bergville WTP, but closer to the uThukela River. There is no specific augmentation of the source in this scenario (run of river abstraction). The RBWSS would supply the areas detailed in **Table 13.94** (table includes the population projections and water demand projections for each water scheme). The total population that would be supplied by this scheme in the year 2050 is projected at 158,690 people and the design capacity for the WTP would be a minimum of 30 Mℓ/day. The project would cost in the region of R 1.32 billion and does not include the estimate for replacing/installing reticulation (up to and including terminal reservoirs). It is recommended that a feasibility study be undertaken to confirm the merit and projected cost of this RBWSS for Okhahlamba LM. The estimated cost for this feasibility study is R6 million.

Table 13.92 Water Schemes To Be Incorporated Into Proposed Okhahlamba RWSS

| Water Scheme Name | Population 2020 | Population 2050 | Demand 2020 Mℓ/d | Demand 2050 Mℓ/d |
|--|-----------------|-----------------|------------------|------------------|
| Howe Wittekop WSS | 1 479 | 1 696 | 0.06 | 0.27 |
| Jagersrust WSS (no uTDM scheme as yet) | 234 | 268 | 0.08 | 0.10 |
| Drakensberg WSS (no uTDM scheme as yet) | 276 | 317 | 0.08 | 0.09 |
| Bergville WSS | 28 483 | 32 648 | 5.13 | 6.59 |
| Colenso WSS | 7 138 | 8 182 | 1.69 | 2.01 |
| Langkloof WSS | 1 607 | 1 842 | 0.06 | 0.29 |
| Winterton WSS | 6 743 | 7 729 | 1.50 | 1.80 |
| Zwelisha Moyeni WSS | 50 325 | 57 684 | 8.78 | 10.80 |
| Bergville Future (no uTDM scheme as yet) | 20 332 | 23 305 | 1.44 | 3.92 |
| Zwelisha Moyeni Future (no uTDM scheme as yet) | 19 966 | 22 886 | 1.39 | 3.78 |
| Amangwane WSS (no uTDM scheme as yet) | 1 862 | 2 134 | 0.13 | 0.36 |
| Totals | 138 445 | 158 690 | 20.34 | 30.01 |

A Regional Bulk Water Supply Scheme (RBWSS) for Alfred Duma LM should be developed with either a source from a raised Spioenkop Dam (as discussed above) or by constructing the proposed Jana Dam and supplying water from this point. The exact location of the WTP for this regional scheme would still have to be determined. However, if the WTP was located near the existing Ezakheni WTP then, as an interim measure, the WTP could be constructed in the medium term. In this scenario the WTP could make use of available water in the uThukela River even before the water resource infrastructure is constructed. The RBWSS would supply the areas detailed in **Table 13.93** (table includes the population projections and water demand projections for each water scheme). The total population that would be supplied by this scheme, in the year 2050, is projected at 308,923 people and the design capacity for the WTP would be a minimum of 80 Mℓ/day. The project would cost in the region of R 2.8 billion and does not include the estimate for replacing/installing reticulation (ie, only the bulk components to supply terminal reservoirs). It is recommended that a feasibility study be undertaken to confirm the merit and projected cost of this RBWSS for Alfred Duma LM. The estimated cost for this feasibility study is R 10 million.

Table 13.93 Water Schemes To Be Incorporated Into Proposed Alfred Duma RWSS

| Water Scheme Name | Population 2020 | Population 2050 | Demand 2020 Mℓ/day | Demand 2050 Mℓ/day |
|---|-----------------|-----------------|--------------------|--------------------|
| Driefontein WSS | 73 365 | 84 093 | 12.62 | 15.75 |
| Ezakheni WSS | 81 096 | 92 955 | 22.64 | 26.96 |
| Ladysmith WSS | 92 969 | 106 564 | 26.81 | 31.92 |
| Ngedlengedleni WSS | 4 182 | 4 793 | 0.74 | 0.89 |
| Tugela Estates WSS | 11 148 | 12 778 | 1.99 | 2.37 |
| Blue Bank BH WSS | 638 | 732 | 0.02 | 0.12 |
| Colenso WSS existing and Future (no uTDM scheme as yet, rural area) | 3 756 | 4 305 | 0.18 | 0.70 |
| Bester WSS (no uTDM scheme as yet) | 413 | 473 | 0.03 | 0.08 |
| Lusitania WSS (no uTDM scheme as yet) | 598 | 686 | 0.09 | 0.11 |
| Mtontwane WSS (no uTDM scheme as yet) | 1 347 | 1 544 | 0.11 | 0.26 |
| Totals | 269 512 | 308 923 | 65.24 | 79.15 |

A reconciliation strategy study should be undertaken to update the water balance (**Section 12.4.1**) for this region, as it is critical in assessing the viability of the above mentioned options.

(b) Sundays Region

The Sundays Region is part of the uThukela River System and therefore the first and second recommendations noted in **Section 13.5.1 (a)** above viz. the updating of the hydrology and yield analysis, the implementation of WC/WDM are also applicable to this region. A reconciliation strategy study should be undertaken to update the water balance (**Section 13.4.2**) for this region.

Additionally, the following recommendations are made for the Sundays Region:

- i. Investigate the feasibility of coring a hole in the lower section of the Olifantskop Dam Wall, and install a scour valve on that outlet in order to facilitate regular scouring of the dam during higher inflows. This will result in lower silt retention within the Olifantskop Dam.⁵⁹
- ii. *Investigate the feasibility of the following potential augmentation options.* The DWA 2011 Reconciliation Report for the Ekuvukeni System identified two possible water resource options for Olifantskop Dam:
 - An off-channel storage on the Pehlwa River (**Figure 13.79**). “The cumulative MAR at the outlet of V60C downstream of Olifantskop Dam is 107.81 million m³. There would be an abstraction works at Olifantskop Dam which would have to take into account the high sediment loads of the river. There would be a raw water bulk main to pump to an off channel storage dam approximately 3 km away with a static head of approximately 20 m” (DWA 2011: 31).

⁵⁹ Personal communication, Prof Gerrit Basson, Professor Water Resources, University of Stellenbosch (2019).

- A dam at the confluence of the Sundays River and Wasbank River (**Figure 13.79**). “The MAR at the confluence of the two rivers is 90.42 million m³/annum, excluding quaternary catchment V60A where the Slangdraai Dam is located. A dam with a live storage capacity of 50% of the reduced MAR (i.e. to take account of the Reserve) will provide a gross yield of approximately 18.55 million m³/annum. The big dam is required to take into account the high sediment loads of the Sundays River. This together with WC/WDM will be sufficient and provide the headroom required to meet the future raw water requirements for the high growth scenario until 2030 and beyond” (DWA 2011: 32).
- Develop a new dam in the upper reaches of the Sundays River in an area which would not be impacted by excessive siltation. Water could then be released from this dam to the Olifantskop Dam / abstraction. The location of this dam would be to the left of the N11, as indicated on **Figure 13.79** of this document.
- *The above will be investigated as long term options together with supply from a regional scheme located near Ezakheni.*

(c) Bushmans Region

- The Bushmans Region is part of the uThukela River System and first and second recommendations noted in **Section 13.5.1 (a)** above viz. the updating of the hydrology and yield analysis, the implementation of WC/WDM are also applicable to this region, are also recommended here. A reconciliation strategy study should be undertaken to update the water balance as noted in **Section 13.4.3**.

Additionally, the following recommendations are noted for the Bushmans Region:

- A Regional Bulk Water Supply Scheme (RBWSS) for Inkosi Langalibalele LM** should be developed with the source as the Wagendrift Dam, as discussed and supported in **Section 13.4.3**. The RBWSS would supply the areas detailed in **Table 13.94** (table includes the population projections and water demand projections for each water scheme). The total population that would be supplied by this scheme in the year 2050 is projected at 356,033 people and the design capacity for the WTP would be a minimum of 71 ML/day. The project would cost in the region of R 2.3 billion and does not include the estimate for replacing/installing reticulation. It is recommended that a feasibility study be undertaken to confirm the merit and projected cost of this RBWSS for Inkosi Langalibalele LM. The estimated cost for this feasibility study is R 10 million.

Table 13.94 Water Schemes To Be Incorporated Into Proposed Inkosi Langalibalele RWSS

| Water Scheme Name | Population 2020 | Population 2050 | Demand 2020 Mℓ/d | Demand 2050 Mℓ/d |
|---|------------------------|------------------------|-------------------------|-------------------------|
| Cornfields/Thembalihle WSS | 6 201 | 7 108 | 1.10 | 1.31 |
| Indaka WSS | 101 137 | 115 926 | 17.61 | 21.00 |
| Emoyeni-Epangweni WSS | 25 705 | 29 464 | 4.08 | 5.14 |
| Estcourt WSS | 70 847 | 81 207 | 17.09 | 20.82 |
| Estcourt Rudimentary WSS | 44 167 | 50 625 | 7.77 | 9.33 |
| Loskop-Bhekuzulu WSS | 31 680 | 36 312 | 5.47 | 6.78 |
| Weenen/Kwanobamba WSS (includes Weenen North) | 15 271 | 17 504 | 1.77 | 3.13 |
| Weenen South WSS (no uTDM scheme as yet) | 6 102 | 6 994 | 0.21 | 1.12 |
| KwaNdema WSS (no uTDM scheme as yet) | 1 262 | 1 447 | 0.30 | 0.36 |
| Frere WSS (no uTDM scheme as yet) | 1 353 | 1 551 | 0.25 | 0.30 |
| Etatane 2 WSS (no uTDM scheme as yet) | 823 | 943 | 0.13 | 0.16 |
| Empangweni WSS (no uTDM scheme as yet) | 6 064 | 6 950 | 1.09 | 1.37 |
| Totals | 310 611 | 356 033 | 56.88 | 70.79 |

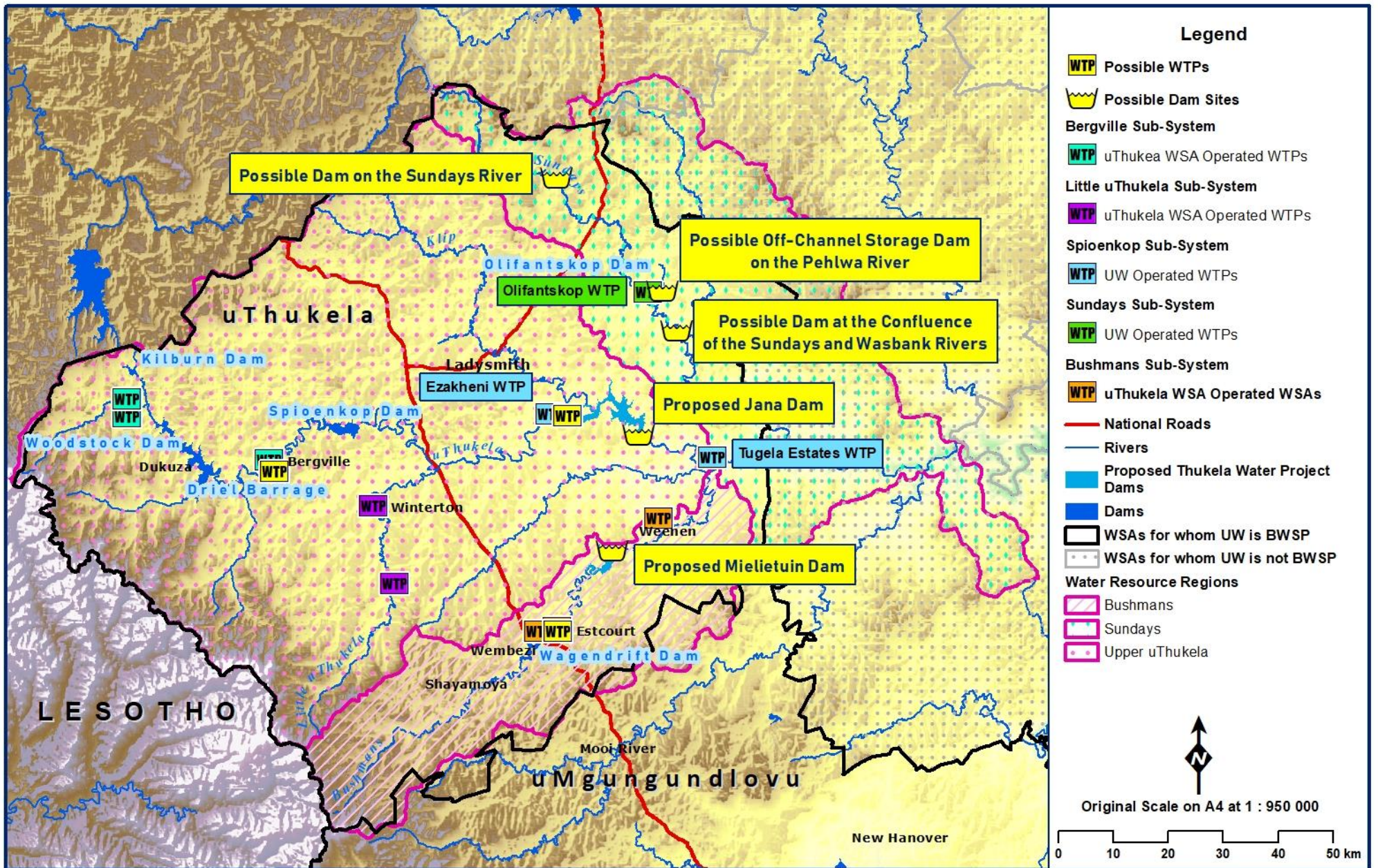

Figure 13.79 Possible water resource infrastructure options to be investigated (after DWA 2000 and DWA 2011, KZN DoT 2017, MDB 2016, Umgeni Water 2019, WR2012).

(d) Ezakheni Water Treatment Plant and Supply System

(i) Short-Term Recommendations

It was noted in **Section 4.7 in Volume 1** that, whilst non-revenue water (NRW) is decreasing in uThukela District Municipality (**Figure 4.6** and **Figure 4.7**), it was still reported in 2017/2018 as 60.9% which is considered high. The status of NRW has improved marginally, with figures of 57.1% reported in 2018/2019. These figures are doubted by role-players in the water sector due to the lack of water meters in uThukela DM i.e. the WSA makes numerous assumptions and estimates when reporting. Accurate reporting will only be possible once the WSA prioritises the installation of water meters at strategic points in the water networks and it is strongly recommended that the WSA utilise available grants such as Water Services Infrastructure Grant (WSIG) and Municipal Infrastructure Grant (MIG) for meter installation and water conservation water demand management (WCWDM) projects. As shown in **Section 13.3.2 (a)**, the water leaks at Ezakheni WTP are significant and the current lack of meters is preventing the determination of a comprehensive water balance. Meters will be installed in the plant during the second half of 2019.

The immediate short-term intervention is to minimise the water losses of the entire water supply system to ensure the optimal and efficient operation of the plant and distribution system. This is to include a revenue enhancement project, where unauthorised connections (that are not on pumping mains or gravity mains) are regularised through the installation of domestic meters. Payment for water consumption by the non-indigents will decrease the water demand.

Flow meters should be installed on various treatment plant components, including the inlet and outlet of the system to ensure a realistic water balance of the system.

The infrastructure is in an extremely poor state and requires significant rehabilitation and renewal work to stabilise operations in addition to the implementation of a preventative maintenance programme. Currently, maintenance is reactive in nature and this is mainly due to the increasing failures being experienced as a result of the lack of maintenance previously undertaken. The ageing infrastructure at the abstraction pump station and the water treatment plant requires replacement to minimise the high water losses.

(ii) Medium-Term Recommendations

The suspended solids of the raw water (due to high turbidity) cause frequent failures of the raw water pump sets. It is recommended that a sediment exclusion be investigated at the raw water abstraction to extend the design life of the raw water pumps and improve the efficiency of the treatment process. Due to the failure of all raw water pump sets between January and March 2019, all six raw water pumps will be replaced with new APE pumps designed for sediment exclusion. The intake structure and weir arrangement is also being reviewed to reduce the amount of sediment entering the sump. The pump station is being sized to double the WTP capacity (to a possible 65 Mℓ/day) with the use of variable speed drives. The intention is to upgrade the WTP to a possible 65 Mℓ/day in the medium term, while the Spioenkop Dam feasibility study is conducted (as noted in (iii) below). The site footprint and available water makes it amenable to upgrade the capacity of the WTP and augment areas of Ekuvukeni currently supplied by Olifantskop WTP.

(iii) Long-Term Recommendations

A long-term solution must be considered for the supply of water to the entire region. A Regional Bulk Water Supply Scheme (RBWSS) should be developed with either a source from a raised Spioenkop Dam (feasibility of this option still to be determined) or by constructing the proposed Jana Dam and supplying water from this point. The exact location of the WTP for this regional scheme would still have to be determined. However, if the WTP was located near the existing Ezakheni WTP then, as an interim measure, the WTP could be constructed in the short to medium term. In this scenario the WTP could make use of available water in the uThukela River even before the water resource infrastructure is constructed [This is described above in greater details in **Section 13.5.2 (a) iii**].

(e) Tugela Estates Water Treatment Plant and Supply System

(i) Short-Term Recommendations

It is recommended that an immediate water demand management programme be implemented to minimise the water losses. This is to include a revenue enhancement project, where unauthorised connections (that are not on pumping mains or gravity mains) are regularised through the installation of domestic meters. Payment for water consumption by the non-indigents will decrease the water demand.

(ii) Medium-Term Recommendations

The immediate short-to-medium-term intervention would be to assess the viability of increasing the Water Treatment Plant capacity to eliminate the “water-shedding” scenario and to minimise the water losses in the supply system. A detailed demand assessment is to be conducted to verify the demand in order to size the upgrade of the system.

The 2019 Umgeni Water Process Audit Report (Process Audit: Tugela Estates, 2019/38) conducted by Process Services lists a number of failures, which renders the WTP inefficient. The report further proposes solutions to ensure a more efficient operational process. This should be taken into account in the assessment for the upgrade of the WTP.

(iii) Long-Term Recommendations

The long-term solution would be to obtain water from a regional scheme from an upgraded Ezakheni WTP (where the proposed regional bulk WTP is built and commissioned at Ezakheni, whilst augmentation of water resources such as construction of the proposed Jana Dam are under way) [This is described above in greater detail in **Section 13.5.2 (a) iii**].

(f) Olifantskop Water Treatment Plant and Supply System

(i) Short-Term Recommendations

Recently, the demand in the supply has seen exponential growth and the water supply to this entire area has to be re-assessed. The immediate short-term solution would be to implement Water

Demand Management measures. This is to include a revenue enhancement project, where unauthorised connections (that are not on pumping mains or gravity mains) are regularised through the installation of domestic meters. Payment for water consumption by the non-indigents will decrease the water demand.

(ii) Medium-Term Recommendations

The medium to long-term recommendations will be to investigate the supply to the Ekuvukeni area from an upgraded Ezakheni WTP (or from the regional scheme described above, where the new Ezakheni WTP is built and commissioned, whilst augmentation of water resources such as construction of the proposed Jana Dam are under way).

(iii) Long-Term Recommendations

The medium to long-term recommendations will be to:

- investigate the supply to the Ekuvukeni area from an upgraded Ezakheni WTP or from the regional scheme described above, where the proposed regional bulk WTP is built and commissioned at Ezakheni, whilst augmentation of water resources such as construction of the proposed Jana Dam are under way). A new 17km rising main would link the proposed regional bulk WTP to Ekuvukeni WSS. The RBWSS is described above in greater details in **Section 13.5.2 (a) iii**. As identified in **Section 13.3.2 (c)**, the lack of a sustainable raw water resource is a major constraint. The recommendations for the water resources are discussed in **Section 13.5.2 (b)**.
- Develop a new dam in the upper reaches of the Sundays River in an area which would not be impacted by excessive siltation. Water could then be released from this dam to the Olifantskop Dam / abstraction. The location of this dam would be to the northwest of the N11, as indicated on **Figure 13.79** of this document.

(g) All other uTDM Water Treatment Plants and Supply Systems

Umgeni water does not operate any WTPs (at present) in uTDM aside from the three WTPs detailed above (Ezakheni WTP, Tugela Estates and Olifantskop WTP). However, in regards to specific recommendations for these WTPs/schemes, the following apply:

(i) Short-Term to Medium Term Recommendations

- The immediate short-term solution within the existing WSS of uTDM would be to implement Water Demand Management measures. This is to include a revenue enhancement project, where unauthorised connections (that are not on pumping mains or gravity mains) are regularised through the installation of domestic meters. Payment for water consumption by the non-indigents will decrease the water demand.
- Process Services and Engineering Services were requested to conduct an assessment of all Waterworks (WW) under uThukela District Municipality in June 2017. Cost estimates to refurbish various components of the assets have been completed for each WW and are

summarised in **Table 13.95** . Each refurbishment budget has been divided into a prioritised list of urgent, required and recommended actions. A total replacement cost has also been estimated, based on Umgeni Water Planning Services’ broad projected cost estimates of R8 million to R10 million per Mℓ.

Table 13.95 Cost estimates for refurbishment of uTDM WTPs

| Waterworks | Year 1 | Year 3 | Year 5 | TOTAL | Replacement Cost |
|-----------------|------------|-------------|-------------|--------------|------------------|
| Ezakheni | R7 385 000 | R2 550 000 | R6 510 000 | R 16 445 000 | R360 000 000 |
| George Cross | R4 412 000 | R 3 245 000 | R4 150 000 | R11 807 000 | R168 000 000 |
| Ladysmith | R5 315 000 | R2 105 000 | R7 090 000 | R14 510 000 | R 184 000 000 |
| Archie Rodel | R4 205 000 | R 1 510 000 | R2 595 000 | R8 310 000 | R128 000 000 |
| Olifanstskop | R4 217 000 | R1 522 000 | R1 475 000 | R 7 214 000 | R10 000 000 |
| Zwelisha Moyeni | R3 746 000 | R1 125 000 | R 1 840 000 | R 6 711 000 | R 40 000 000 |
| Bergville | R2 535 000 | R1 507 000 | R1 670 000 | R5 712 000 | R22 800 000 |
| Colenso | R1 805 000 | R2 430 000 | R2 205 000 | R 6 440 000 | R 21 120 000 |
| Winterton | R4 060 000 | R2 867 000 | R6 750 000 | R 13 677 000 | R 16 000 000 |
| Weenen | R1 805 000 | R1 386 000 | R995 000 | R 4 186 000 | R11 200 000 |
| Tugela Estates | R2 570 000 | R1 126 000 | R1 080 000 | R 4 776 000 | R16 000 000 |
| Langkloof | R2 180 000 | R520 000 | R715 000 | R 3 415 000 | R 4 000 000 |

(ii) Long-Term Recommendations

The long term recommendations for these WTPs is for the WSS to receive bulk water from one of the three respective RBWSS described in detail within **Section 13.5.2 (a) iii** and **Section 13.5.2 (c) iii**. All the WSS of uTDM appear in one of the following tables according to the respective area:

- **Table 13.92**
- **Table 13.93**
- and **Table 13.94**.

There are numerous bulk and reticulation projects currently being implemented by the uTDM and these should be taken to completion as these projects cater for the short to medium term (although they do not cater for the 2050 water demand and not at the scale of regional bulk). Most of these projects are funded through the municipal infrastructure grant (MIG) which is managed by CoGTA and the water services infrastructure grant (WSIG), as per **Table 13.96**.

There is R 49.4 million allocation by DWS in the MTEF for the Driefontein-Indaka Water Project, but the project is not advancing well due to the need to reassess the feasibility of such a project. This is primarily due to the issue of availability (allocation) of the water resources on the project as there is no surplus water presently available for extraction from uThukela System for this proposed water infrastructure.

Table 13.96 Active WSIG Projects of uTDM (personal communication DWS, March 2020)

| Name Of Project | Estimated Project Cost | Project Stage | 2019/2020 Allocation |
|---|------------------------|---------------|----------------------|
| Mimosadale Water Supply | 14,135,510 | Completed | |
| Wembezi WCDM | 275,000,000 | Construction | 39,900,000 |
| Reticulation To Ennersdale, Epangwini And Bhekuzulu Phase 1-4 | 45,963,880 | Construction | 33,500,000 |
| Moyeni/Zwelisha WTW Upgrade And Bulk Rising Main | 6,021,948 | Planning | 3,000,000 |
| Spring Protection District Wide | 179,610,473 | Construction | 15,000,000 |
| Estcourt Industrial Pipeline Upgrade | 31,321,375 | Construction | 16,600,000 |
| Drought Relief Intervention | 38 000 000 | Construction | 38 000 000 |
| TOTAL | 537,917,676 | | 108,000,000 |

Table 13.97 Active MIG Projects of uTDM (personal communication, CoGTA, June 2020)

| Provincial Reference Number | Project Title (as per MIG 1 form) | Project Status | Actual Project Cost (Tender sum + fees) |
|-----------------------------|--|----------------|---|
| 2008MIGFDC23160811 | Ntabamhlophe Water Supply Phase 4 to 13 (AFA) MIS 220289 | Construct. 80% | 212 031 939.40 |
| 2013MIGFDC23213176 | Kwanobamba-Ezitendeni (Weenen) Water Supply Project (AFA) MIS 288537 | Construct. 80% | 207 769 329.35 |
| 2015MIGFDC23231717 | Weenen - Ezitendeni : Sanitation Project | Construct. 40% | 131 998 063.00 |
| 2016MIGFDC23240416 | Ezakheni E Sanitation Phase 2 | Construct. 80% | 28 273 423.00 |
| 2017MIGFDC23260323 | Water Supply to Ekuvukeni | Construct. 40% | 131 187 098.55 |
| 2017MIGFDC23244418 | Waterborne Sanitation Project : Bergville Phase 2 | Construct. 40% | 54 807 406.83 |
| 2006MIGFDC23113342 | Bergville Bulk Water Supply Extension and Reticulation | Construct. 80% | 24 362 664.00 |
| 2019MIGFDC23324641 | Infrastructure Replace & Refurbish Thukela District Wide | Construct. 40% | 72 052 687.35 |
| 2019MIGFDC23363261 | uTDM COVID 19 Water and Sanitation Intervention Project | Registered | 37 894 306.47 |
| 2012MIGFDC23207053 | Umnambithi Ladysmith Sanitation Project Ward 19 | Registered | 18 432 015.00 |

(h) Tugela Ferry (and Pomeroy) Water Treatment Plant and Supply Systems

(i) Short-Term to Medium Term Recommendations

The immediate short-term solution within the existing WSS of uTDM would be to implement Water Demand Management measures. This is to include a revenue enhancement project, where unauthorised connections (that are not on pumping mains or gravity mains) are regularised through the installation of domestic meters. Payment for water consumption by non-indigents will also decrease water demand. The Pomeroy WTP is to be decommissioned as soon as the new 8Mℓ/day Tugela Ferry WTP is commissioned (in 2020).

(ii) Long-Term Recommendations

A new bulk water supply scheme has been constructed at Tugela Ferry and will be commissioned in the very near future (2020). It includes a new 8 Mℓ/day WTP, run of river abstraction and a series of reservoirs and pipelines that supplies up to and including the town of Pomeroy.

The long term recommendation is to upsize the new WTP as and when required, as it has been built in a compartmentalized fashion, that facilitates/supports future upgrade in order to provide for the 2050 water demand (See **Table 13.98**). The recommendation for Tugela Ferry is to keep the existing supply as a stand alone scheme as it is isolated in regards to proximity to other towns/settlements. The combined capacity of the new WTP and the older WTP equates to 11 Mℓ/day and will not provide the required future demand of 21Mℓ/day. This confirms the need to upgrade the Tugela Ferry WSS in the medium term as the theoretical demand already exceeds the combined capacity of the existing WTPs (new and old). The upgrade should cost in the region of R 930 million and would include the WTP upgrade, reservoirs, pumps stations and bulk pipelines).

Table 13.98 Tugela Ferry Population and Water Demand Projections

| Water Scheme Name | Population 2020 | Population 2050 | Demand 2020 Mℓ/d | Demand 2050 Mℓ/d |
|-------------------|-----------------|-----------------|------------------|------------------|
| Tugela Ferry | 44 703 | 62 442 | 8.34 | 12.12 |
| Pomeroy | 35 554 | 49 662 | 6.06 | 8.82 |
| Totals | 80 256 | 112 105 | 14 | 21 |

REFERENCES

Department of Environmental Affairs and Geoterrimage (GTI). 2015. *2013 – 2014 South African National Land-Cover Dataset*. March 2015, Version 05#2 (DEA Open Access). GIS Dataset.

Department of Water Affairs and Forestry. 1998. *Alternative Sources of Water Supply to Ladysmith/Emnambithi Area – Main Report*. Prepared by Bosch & Associates SA (Pty) Ltd in associations with Davies Lynn & Partners, Fongoqa Skade & Toyi and Guy Nicholson Consulting Services as part of the Thukela Water Project Feasibility Study. DWAF Report No. PB V000-00-6099. DWAF: Pretoria.

Department of Water Affairs and Forestry. 2000. *Thukela Water Project Feasibility Study. Engineering Investigations. Optimum Type and Route of Aqueduct at Various Design Capacities*. Prepared by Thukela Basin Consultants, as part of the Thukela Water Project Feasibility Study. DWAF Report No. PBV000-00-4799. DWAF: Pretoria.

Department of Water Affairs and Forestry. 2001. *Operation of the Thukela River System First Draft*. DWAF: Pretoria.

Department of Water Affairs and Forestry. 2004. *Internal Strategic Perspective: Thukela Water Management Area*. Prepared by Tlou and Matji (Pty) Ltd, WRP (Pty) Ltd and DMM CC on behalf of the Directorate: National Water Resource Planning (East). DWAF Report No. P WMA 07/000/00/0304. DWAF: Pretoria.

Department of Water Affairs and Forestry. 2006. *Guidelines for Water Supply Systems Operating and Management Plans During Normal and Drought Conditions Appendix C: The Integrated Vaal River System*. Prepared by Ninham Shand (Pty) Ltd in association with Semanya Furumele (Pty) Ltd on behalf of the Directorate: Water Resources Planning Systems. DWAF Report No. RSA C000/002305. DWAF: Pretoria.

Department of Water Affairs. 2011. *Development of a Reconciliation Strategy for All Towns in the Eastern Region uThukela District Municipality: First Stage Reconciliation Strategy for Colenso Water Supply Scheme Area – Emnambithi/Ladysmith Local Municipality*. Prepared by Water for Africa (Pty) Ltd; Aurecon (Pty) Ltd; Water Geosciences and Charles Sellick and Associates for Directorate: National Water Resources Planning. Contract WP 9712. Department of Water Affairs: Pretoria.

Department of Water Affairs. 2011. *Development of a Reconciliation Strategy for All Towns in the Eastern Region uThukela District Municipality: First Stage Reconciliation Strategy for Ezakheni Water Supply Scheme Area – Emnambithi/Ladysmith Local Municipality*. Prepared by Water for Africa (Pty) Ltd; Aurecon (Pty) Ltd; Water Geosciences and Charles Sellick and Associates for Directorate: National Water Resources Planning. Contract WP 9712. Department of Water Affairs: Pretoria.

Department of Water Affairs. 2011. *Development of a Reconciliation Strategy for All Towns in the Eastern Region uThukela District Municipality: First Stage Reconciliation Strategy for Ladysmith Water Supply Scheme Area – Emnambithi/Ladysmith Local Municipality*. Prepared by Water for

Africa (Pty) Ltd; Aurecon (Pty) Ltd; Water Geosciences and Charles Sellick and Associates for Directorate: National Water Resources Planning. Contract WP 9712. Department of Water Affairs: Pretoria.

Department of Water Affairs. 2011. *Development of a Reconciliation Strategy for All Towns in the Eastern Region uThukela District Municipality: First Stage Reconciliation Strategy for Loskop Water Supply Scheme Area – Imbabazane Local Municipality*. Prepared by Water for Africa (Pty) Ltd; Aurecon (Pty) Ltd; Water Geosciences and Charles Sellick and Associates for Directorate: National Water Resources Planning. Contract WP 9712. Department of Water Affairs: Pretoria.

Department of Water Affairs. 2011. *Development of a Reconciliation Strategy for All Towns in the Eastern Region uThukela District Municipality: First Stage Reconciliation Strategy for Bergville Water Supply Scheme Area – Okhalamba Local Municipality*. Prepared by Water for Africa (Pty) Ltd; Aurecon (Pty) Ltd; Water Geosciences and Charles Sellick and Associates for Directorate: National Water Resources Planning. Contract WP 9712. Department of Water Affairs: Pretoria.

Department of Water Affairs. 2011. *Development of a Reconciliation Strategy for All Towns in the Eastern Region uThukela District Municipality: First Stage Reconciliation Strategy for Winterton Water Supply Scheme Area – Okhalamba Local Municipality*. Prepared by Water for Africa (Pty) Ltd; Aurecon (Pty) Ltd; Water Geosciences and Charles Sellick and Associates for Directorate: National Water Resources Planning. Contract WP 9712. Department of Water Affairs: Pretoria.

Department of Water Affairs. 2011. *Development of a Reconciliation Strategy for All Towns in the Eastern Region uThukela District Municipality: First Stage Reconciliation Strategy for Zwelisha Moyeni Water Supply Scheme Area – Okhalamba Local Municipality*. Prepared by Water for Africa (Pty) Ltd; Aurecon (Pty) Ltd; Water Geosciences and Charles Sellick and Associates for Directorate: National Water Resources Planning. Contract WP 9712. Department of Water Affairs: Pretoria.

Department of Water Affairs. 2011. *Development of a Reconciliation Strategy for All Towns in the Eastern Region uThukela District Municipality: First Stage Reconciliation Strategy for Weenen Water Supply Scheme Area – Umtshezi Local Municipality*. Prepared by Water for Africa (Pty) Ltd; Aurecon (Pty) Ltd; Water Geosciences and Charles Sellick and Associates for Directorate: National Water Resources Planning. Contract WP 9712. Department of Water Affairs: Pretoria.

Department of Water Affairs. 2011. *Development of a Reconciliation Strategy for All Towns in the Eastern Region uThukela District Municipality: First Stage Reconciliation Strategy for Estcourt Water Supply Scheme Area – Umtshezi Local Municipality*. Prepared by Water for Africa (Pty) Ltd; Aurecon (Pty) Ltd; Water Geosciences and Charles Sellick and Associates for Directorate: National Water Resources Planning. Contract WP 9712. Department of Water Affairs: Pretoria.

Department of Water Affairs. 2012. *Water Supply and Drought Operating Rules for Stand Alone Dams and Schemes Typical of Rural/Small Municipal Water Supply Schemes Eastern Cluster Ekuvukeni Water Supply Scheme: Oliphantskop Dam Decision Support System February 2012*. Prepared by BKS for Department of Water Affairs. Project No.: P RSA 000/00/14711/Eastern Clusters/Ekuvukeni WSS. DWA: Pretoria.

Department of Water and Sanitation. 2019. *Registration Details of a Dam Registered in terms of Dam Safety Legislation in terms of Chapter 12 of the National Water Act (Act 36 of 1998)*. April 2019. Spreadsheet.

Department of Water and Sanitation. 2018. *Hydrographic Surveys Dam List 2018*. 2018. Spreadsheet.

Department of Water and Sanitation. 2018. *Implementation and Maintenance of the Water Reconciliation Strategy for Richards Bay and Surrounding Towns: Water Availability Status of the Thukela River System Memorandum (First Draft)*. September 2018. Project No.: P WMA 04/W100/00/9218. DWS: Pretoria.

Department of Water and Sanitation. 2018. *National Water and Sanitation Master Plan Volume 1: Call to Action (Version 10.1) Ready for the Future and Ahead of the Curve 31 October 2018*. Pretoria: Department of Water and Sanitation.

Department of Water and Sanitation. 2018. *National Water and Sanitation Master Plan Volume 2: Comprehensive Action Plan (Version 3) 13 March 2018*. Pretoria: Department of Water and Sanitation.

Department of Water and Sanitation. 2018. *Vaal River System Annual Operating Analysis 2018/19 SOF Meeting*. Presentation. DWS: Pretoria.

KZN Department of Transport. 2017. *Road Infrastructure Framework of South Africa*. GIS Dataset.

Municipal Demarcation Board. 2016. *Municipal and Ward Boundaries*. GIS Dataset. <www.demarcation.org.za>.

South African Water Research Commission. 2015. *Water Resources 2012*. 2015. GIS datasets.

South African Water Research Commission. 2015. *Water Resources 2012*. 2015. Spreadsheet.

Umgeni Water. 2020. *Meter Readings Annexure A uThukela District Municipality*. 2020. Spreadsheet (March 2020).

Umgeni Water. 2019. *Draft Infrastructure Master Plan 2019/2020 Geodatabase*. GIS Dataset.

Umgeni Water. 2019. *Draft uThukela District Municipality Water Balance Investigation Report*. May 2019. Prepared by Water Demand Management Unit. Umgeni Water: Pietermaritzburg.

Umgeni Water. 2019. *Draft uThukela System Equipment Details Report*. May 2019. Prepared by Water Demand Management Unit. Umgeni Water: Pietermaritzburg.

Umgeni Water. 2019. *Ezakheni Waterworks Process Audit 2019*. May 2019. Report No. 2019/37. Prepared by Process Services. Umgeni Water: Pietermaritzburg.

Umgeni Water. 2019. *Meter Readings Annexure A uThukela District Municipality*. 2019. Spreadsheet.

Umgeni Water. 2019. *Olifantskop Waterworks Process Audit 2019*. May 2019. Report No. 2019/39. Prepared by Process Services. Umgeni Water: Pietermaritzburg.

Umgeni Water. 2019. *Tugela Estates Waterworks Process Audit 2019*. May 2019. Report No. 2019/38. Prepared by Process Services. Umgeni Water: Pietermaritzburg.

Umgeni Water. 2019. *Universal Access Plan Phase 3 – Progressive Development of a Regional Concept Secondary Bulk Water Master Plan for the uThukela District Municipality*. Prepared by Mariswe Consulting (Pty) Ltd in Association with JTN Consulting for Umgeni Water. Contract No. 2018/164. Umgeni Water: Pietermaritzburg.

Umgeni Water. 2018. *Draft Ezakheni System Balance Report*. November 2018. Prepared by Water Demand Management Unit. Umgeni Water: Pietermaritzburg.

Umgeni Water. 2017. *Archie Rodel Waterworks Plant Assessment 2017*. October 2017. Report No. 1408. Prepared by Process Services. Umgeni Water: Pietermaritzburg.

Umgeni Water. 2017. *Bergville Waterworks Plant Assessment 2017*. October 2017. Report No. 1411. Prepared by Process Services. Umgeni Water: Pietermaritzburg.

Umgeni Water. 2017. *Colenso Waterworks Plant Assessment 2017*. October 2017. Report No. 1412. Prepared by Process Services. Umgeni Water: Pietermaritzburg.

Umgeni Water. 2017. *Ezakheni Waterworks Process Assessment 2017*. October 2017. Report No. 1405. Prepared by Process Services. Umgeni Water: Pietermaritzburg.

Umgeni Water. 2017. *George Cross Waterworks Plant Assessment 2017*. October 2017. Report No. 1406. Prepared by Process Services. Umgeni Water: Pietermaritzburg.

Umgeni Water. 2017. *Ladysmith Waterworks Plant Assessment 2017*. October 2017. Report No. 1407. Prepared by Process Services. Umgeni Water: Pietermaritzburg.

Umgeni Water. 2017. *Langkloof Waterworks Plant Assessment 2017*. October 2017. Report No. 1416. Prepared by Process Services. Umgeni Water: Pietermaritzburg.

Umgeni Water. 2017. *Olifantskop Waterworks Process Assessment 2017*. October 2017. Report No. 1409. Prepared by Process Services. Umgeni Water: Pietermaritzburg.

Umgeni Water. 2017. *Tugela Estates Waterworks Plant Assessment 2017*. October 2017. Report No. 1415. Prepared by Process Services. Umgeni Water: Pietermaritzburg.

Umgeni Water. 2017. *Winterton Waterworks Plant Assessment 2017*. October 2017. Report No. 1413. Prepared by Process Services. Umgeni Water: Pietermaritzburg.

Umgeni Water. 2017. *Weenen Waterworks Plant Assessment 2017*. October 2017. Report No. 1414. Prepared by Process Services. Umgeni Water: Pietermaritzburg.

Umgeni Water. 2017. *Zwelisha Waterworks Plant Assessment 2017*. October 2017. Report No. 1410. Prepared by Process Services. Umgeni Water: Pietermaritzburg.

Umgeni Water. 2016. *Universal Access Plan Phase 2 – Progressive Development of a Regional Concept Plan for the uThukela District Municipality*. Prepared by UWP Consulting (Pty) Ltd in Association with Ziyanda Consulting for Umgeni Water. Contract No. 2015/178. Umgeni Water: Pietermaritzburg.

Umgeni Water. 2016. *Universal Access Plan Phase 2 – Progressive Development of a Regional Concept Plan for the uMzinyathi District Municipality*. Prepared by Hatch Goba Consulting (Pty) Ltd in Association with JTN Consulting for Umgeni Water. Contract No. 2015/178. Umgeni Water: Pietermaritzburg.

ACKNOWLEDGEMENTS

Umgeni Water's comprehensive 2019 Infrastructure Master Plan has been updated and improved to produce this 2020 version. The concerted effort of the Planning Services Department as a whole in producing this document is acknowledged and appreciated. This was all achieved under ever trying conditions with many staff working remotely whilst contending with the COVID-19 Lockdowns. Specific contributions by the various team members deserves acknowledgement:

- Alka Ramnath (Planner) Project management, Section 2, Spatial information, Research and input to all volumes
- Graham Metcalf (Geohydrologist) Groundwater and Wastewater
- Gavin Subramanian (Planning Engineer) Infrastructure on the North Coast and Mhlathuze Systems
- Angus Nicoll (Planning Engineer) Infrastructure on the South Coast and Mgeni Central Systems
- Vernon Perumal (Planning Engineer) Infrastructure on the uMkhomazi, Upper Mzintlava and Upper Umzimkhulu Systems and compiling the Energy Section
- Mark Scott (Planning Engineer) Infrastructure on the Mgeni Inland, uThukela Central and Umfolozi Systems
- Reshina Maharaj (Planning Engineer) Infrastructure on the uMkhuze, uPhongolo and Lake Sibaya Systems
- Nathaniel Padayachee (Planning Engineer) Infrastructure on the Upper uThukela and Buffalo Systems
- Nkosi Cele (Planning Engineer) Infrastructure data acquisition
- Ntuthuko Ngcamu (Head – Water Demand Management Unit) with support from Mathews Nokhanga and Nkukuleko Ndlovu Water Demand Management Section
- Sakhile Hlalukane (Hydrologists) Water resources of the North Coast, South Coast and Upper uThukela Systems
- Sandile Sithole (Hydrologist) Water resources of all systems excluding the North coast, South Coast and Upper uThukela Systems
- Sifiso Khathi (Graduate Trainee – Hydrologist) Mapping and hydrology support
- Thabani Zondi (Graduate Trainee - Hydrologist) Hydrology Support
- Nombuso Dladla (Data Analyst) Spatial information
- Hlgeniwe Cele (Administrator) kept the department functioning throughout the project

The 2020 Infrastructure Master Plan was not completed by the abovementioned people without the valued assistance of numerous other persons and parties. Their contributions are gratefully acknowledged. These include Umgeni Water and WSA Operations Staff, Umgeni Water's Water and Environment Department (water quality), Umgeni Water's Process Services Department (process and treatment details for UW plants and others) and Umgeni Water's Catchment Management Department (climate change).

Kevin Meier,
PLANNING SERVICES MANAGER