

U  
M  
G  
E  
N  
I  
W  
A  
T  
E  
R

# Infrastructure Master Plan 2023 2023/2024 – 2053/2054 Volume 8: Middle uThukela System and uMhlathuze System



**Infrastructure Development Division, Umgeni Water**

310 Burger Street, Pietermaritzburg, 3201, Republic of South Africa  
P.O. Box 9, Pietermaritzburg, 3200, Republic of South Africa  
Tel: +27 (33) 341 1111 / Fax +27 (33) 341 1167 / Toll free: 0800 331 820  
Email: [info@umgeni.co.za](mailto:info@umgeni.co.za) / Web: [www.umgeni.co.za](http://www.umgeni.co.za)





For further information, please contact:

Planning Services  
Infrastructure Development Division  
Umgeni Water

P.O.Box 9, Pietermaritzburg, 3200  
KwaZulu-Natal, South Africa

Tel: 033 341-1522

Fax: 033 341-1218

Email: [info@umgeni.co.za](mailto:info@umgeni.co.za)

Web: [www.umgeni.co.za](http://www.umgeni.co.za)



# UMGENI WATER

## INFRASTRUCTURE MASTER PLAN 2023

2023/2024 – 2053/2054

JUNE 2023

Prepared by:

Digitally signed by Vernon Perumal  
DN: cn=Vernon Perumal, o=Umgeni  
Water, ou=ID: Planning,  
email=vernon.perumal@umgeni.co.  
za, c=ZA  
Date: 2023.06.28 11:49:08 +02'00'

---

**Vernon Perumal PrTechEng**

Planning Engineer

Digitally signed by Mlungisi  
Shabalala  
Date: 2023.06.29 11:50:43  
+02'00'

---

**Mlungisi Shabalala PrSciNat**

Hydrologist

Approved by:

**Kevin  
Meier**

Digitally signed by Kevin Meier  
DN: cn=Kevin Meier, o=Umgeni  
Water, ou=Planning Services,  
email=kevin.meier@umgeni.co.za,  
c=ZA  
Date: 2023.06.28 15:54:30 +02'00'

---

**Kevin Meier PrEng**

Manager: Planning Services

**Kevin Meier**

Digitally signed by Kevin Meier  
DN: cn=Kevin Meier, o=Umgeni Water,  
ou=Planning Services,  
email=kevin.meier@umgeni.co.za, c=ZA  
Date: 2023.06.30 12:32:48 +02'00'

PP

---

**Xolani Chamane PrEng**

Executive: Infrastructure Development



# PREFACE

This Infrastructure Master Plan 2023 describes:

- Umgeni Water’s infrastructure plans for the financial period 2023/2024 – 2053/2054, and
- Infrastructure master plans for other areas outside of Umgeni Water’s Operating Area but within KwaZulu-Natal.

It is a comprehensive technical report that provides information on current infrastructure and on future infrastructure development plans. This report replaces the last comprehensive Infrastructure Master Plan that was compiled in 2022.

The report is divided into **ten** volumes as per the organogram below.

**Volume 1** includes the following sections and a description of each is provided below:

- **Section 2** describes the most recent changes and trends within the primary environmental dictates that influence development plans within the province.
- **Section 3** relates only to the Umgeni Water Operational Areas and provides a review of historic water sales against past projections, as well as Umgeni Water’s most recent water demand projections, compiled at the end of 2021.
- **Section 4** describes Water Demand Management initiatives that are being undertaken by the utility and the status of Water Demand Management Issues in KwaZulu-Natal.
- **Section 5**, which also relates to Umgeni Water’s Operational Area, contains a high level review of the energy consumption used to produce the water volumes analysed in **Section 3**.
- **Section 6** provides an overview of the water resource regions and systems supplied within these regions.

The next eight volumes describe the current water resource situation and water supply infrastructure of the various systems in KwaZulu-Natal, including:

- **Volume 2 Section 7** Mgeni System.
- **Volume 3 Section 8** uMkhomazi System
- **Section 9** uMzimkhulu System
- **Section 10** Mzintlava System
- **Volume 4- Section 11** South Coast System
- **Volume 5 Section 12** North Coast System
- **Volume 6 Section 13** Upper uThukela System
- **Volume 7 Section 14** Buffalo System
- **Volume 8 Section 15** Middle uThukela System
- **Section 16** Mhlathuze System
- **Volume 9 Section 17** Umfolozi System
- **Section 18** uMkhuze / uPhongolo / Lake Sibiya System

**Volume 10, Section 19** describes the wastewater works currently operated by Umgeni Water (shown in pale brown in the adjacent figure) and provides plans for development of additional wastewater treatment facilities. The status of wastewater treatment in WSA’s that are not supplied by Umgeni Water are also described in this section.

# Infrastructure Master Plan 2023/2024

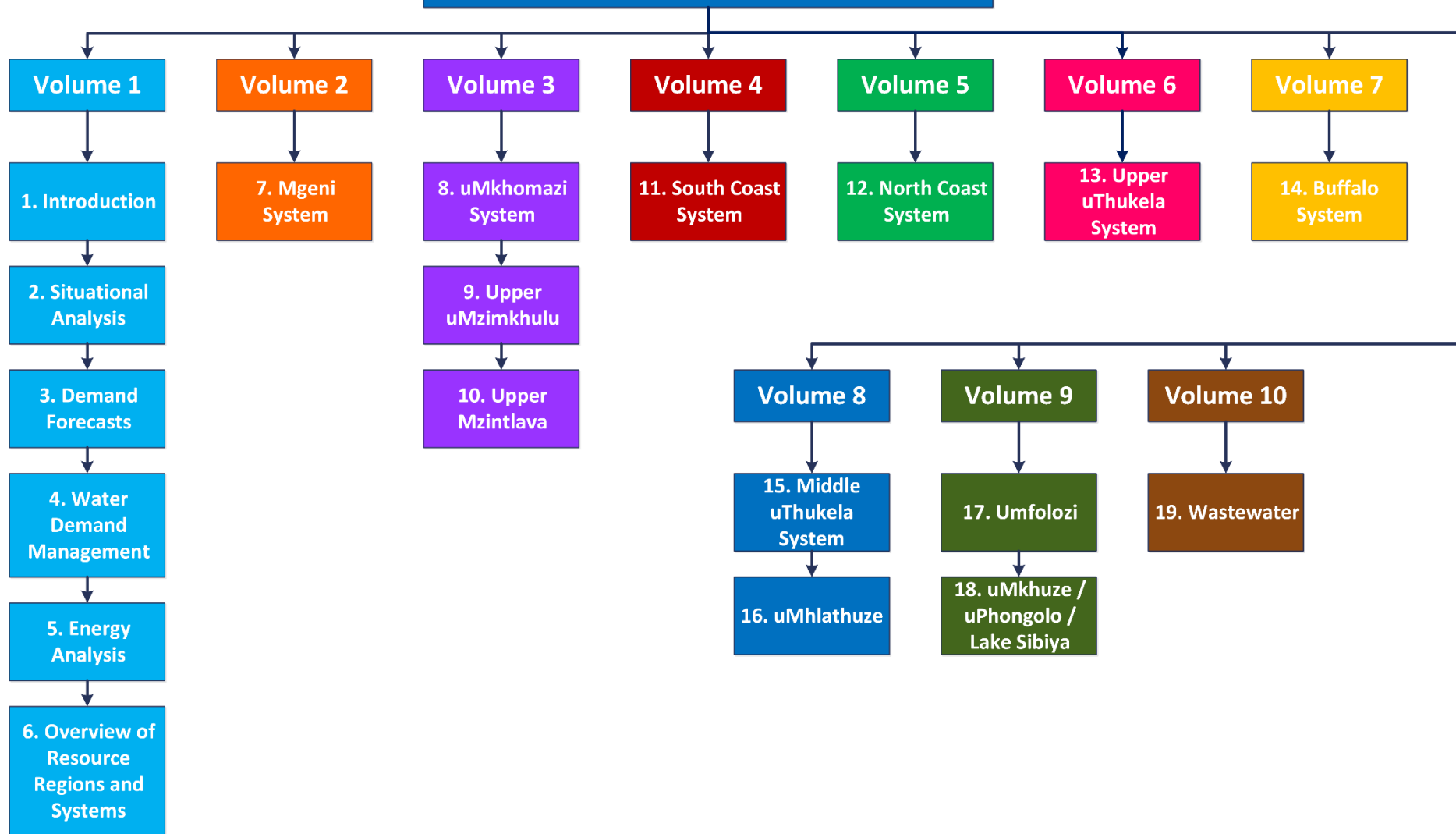

It is important to note that information presented in this report is in a summarised form and it is recommended that the reader refer to relevant planning reports if more detail is sought. Since the primary focus of this Infrastructure Master Plan is on bulk supply networks, the water resource infrastructure development plans are not discussed at length. The Department of Water and Sanitation (DWS), as the responsible authority, has undertaken the regional water resource development investigations. All of these investigations have been conducted in close collaboration with Umgeni Water and other major stakeholders in order to ensure that integrated planning occurs. Details on these projects can be obtained directly from DWS, Directorate: Options Analysis (East).

The Infrastructure Master Plan is a dynamic and evolving document. Outputs from current planning studies, and comments received on this document will therefore be taken into account in the preparation of the next update.

# TABLE OF CONTENTS

Preface .....	i
Table of Contents .....	iv
List of Figures .....	v
List of Tables .....	vi
List of Acronyms.....	viii
List of Units .....	xi
15. Middle uThukela System .....	12
15.1 Synopsis of the Middle uThukela System .....	12
15.2 Water Resources of the Middle uThukela System .....	14
15.2.1 Description of the Middle uThukela System Water Resource Regions .....	14
15.2.2 Reserve.....	19
15.2.3 Existing Water Resource Infrastructure and Yields.....	20
15.2.4 Operating Rules.....	21
15.3 Supply Systems .....	24
15.3.1 Description of the Middle uThukela System .....	24
15.3.2 Status Quo and Limitations of the Middle uThukela System .....	31
15.4 Water Balance/Availability .....	31
15.5 Recommendations for the Middle uThukela System .....	31
15.5.1 System Components .....	31
16. uMhlathuze System .....	34
16.1 Synopsis of the uMhlathuze System .....	34
16.2 Water Resources of the uMhlathuze System .....	37
16.2.1 Description of the uMhlathuze System Water Resource Regions .....	37
16.2.2 Reserve.....	44
16.2.3 Existing Water Resource Infrastructure and Yields.....	45
16.2.4 Operating Rules.....	58
16.3 Supply Systems .....	60
16.3.1 Description of the uMhlathuze System.....	60
16.3.2 Status Quo and Limitations of the uMhlathuze System .....	100
16.4 Water Balance/Availability .....	106
16.5 Recommendations for the uMhlathuze System.....	107
16.5.1 System Components .....	107
16.5.2 Water Resource and Climate Monitoring .....	112
16.5.3 Projects.....	112
References .....	121
Acknowledgements.....	l



# LIST OF FIGURES

Figure 15.1 General layout of the Middle uThukela Region.....	13
Figure 15.2 Middle uThukela land cover.....	16
Figure 15.3 Groundwater potential in the Middle Thukela Region.....	18
Figure 15.4 Ntingwe Dam.....	22
Figure 15.5 Spatial layout of the Makhabeleni Supply System.....	25
Figure 15.6 Schematic of the Makhabeleni Supply System.....	26
Figure 16.1 General layout of the uMhlathuze System.....	36
Figure 16.2 Land cover map of the uMhlathuze Region.....	41
Figure 16.3 Groundwater potential in the uMhlathuze Region.....	43
Figure 16.4 Goedertrouw Dam.....	47
Figure 16.5 Ihlazi Dam (also known as Eshlazi Dam) on 15 March 2017.....	51
Figure 16.6 Rutledge Park Dam.....	53
Figure 16.7 Drought Operating Rules (Curtailment curves) for Eshowe.....	59
Figure 16.8 KCDM and City of uMhlathuze.....	61
Figure 16.9 Nkandla WTP.....	63
Figure 16.10 Schematic of Nkandla WTP Supply System.....	65
Figure 16.11 Thukela Transfer Scheme Abstraction Works.....	67
Figure 16.12 Aerial Photo of Middledrift WTP.....	68
Figure 16.13 Photo of Middledrift WTP Clarifiers.....	68
Figure 16.14 Madungela High Lift Pump Station.....	69
Figure 16.15 Mkhalazi High Lift Pump Station.....	69
Figure 16.16 Schematic of Central uMhlathuze System.....	70
Figure 16.17 Goedertrouw WTP.....	75
Figure 16.18 Schematic of Goedertrouw Supply System.....	76
Figure 16.19 Eshowe WTP.....	80
Figure 16.20 Schematic of Eshowe System.....	81
Figure 16.21 Ngwelezane WTP.....	85
Figure 16.22 Schematic of CoU System.....	86
Figure 16.23 eSikhaleni WTP.....	90
Figure 16.24 uMhlathuze Weir.....	93
Figure 16.25 Nsezi WTP.....	94
Figure 16.26 Mzingazi WTP.....	97
Figure 16.27 Water demand for Nkandla WTP.....	100
Figure 16.28 Water demand for Middledrift WTP.....	101
Figure 16.29 Water demand for Goedertrouw WTP.....	102
Figure 16.30 Water demand for Eshowe WTP.....	103
Figure 16.31 uMhlathuze System Balance.....	106
Figure 16.32 Future Bulk Scenario for CoU.....	110

# LIST OF TABLES

Table 15.1	WTPs located in the Middle uThukela Region (UAP Phase 3 2020: GIS Dataset). .....	12
Table 15.2	Hydrological characteristics of the Middle Thukela Region (WR90, WR2012: Thukela Quat Info WMA 7 7Jul2015 spreadsheet) .....	15
Table 15.3	The present and targeted ecological state of water resources within the Middle uThukela Water Resource Region (DWS, 2023). .....	20
Table 15.4	Supply Area and their respective water sources (Umgeni Water, 2019: 17) .....	21
Table 15.5	Characteristics of Ntingwe Dam. ....	23
Table 15.6	Characteristics of the Makhabeleni WTP. ....	27
Table 15.7	Pump details: Makhabeleni Supply System. ....	28
Table 15.8	Reservoir details: Makhabeleni BWSS. ....	29
Table 15.9	Pipeline details: Makhabeleni BWSS. ....	30
Table 16.1	Hydrological Characteristics of uMhlathuze Region (WR2012: Usutu-Mhlathuze Quat Info WMA 6 July2015). ....	40
Table 16.2	uMhlathuze River Ecological Status (DWS, 2009). ....	45
Table 16.3	Goedertrouw Dam Hydrographic Survey (DWS 2018: Hydrographic Surveys Dams Database, DWS 2019: List of Registered Dams Database, WR2012). ....	48
Table 16.4	Melmoth Off-Channel Storage Dam (DWS 2018: List of Registered Dams Database; UW 2022).....	50
Table 16.5	Eshlazi Dam (DWS 2018: List of Registered Dams Database; DWS 2015: Eshowe Drought Operating Rules Study; UW 2022: Eshlazi Dam Hydrographic Survey). ....	52
Table 16.6	Rutledge Park Dam (DWS 2018: List of Registered Dams Database; DWS 2015: Eshowe Drought Operating Rules Study; UW 2022: Rutledge Park Dam Hydrographic Survey). .	54
Table 16.7	uMhlathuze System yields (DWS 2015). ....	55
Table 16.8	The long-term stochastic yields of uMhlathuze System (DWS 2020). ....	56
Table 16.9	The short-term stochastic yield of uMhlathuze System at different starting storage levels (DWS 2020).....	56
Table 16.10	The long-term stochastic yield of the integrated system of Eshlazi and Rutledge Park Dams for three different scenarios (DWS 2016). ....	57
Table 16.11	The short-term stochastic yield of the integrated system of Eshlazi and Rutledge Park Dams at different starting storage levels (DWS 2016). ....	57
Table 16.12	Characteristics of the Nkandla WTP .....	64
Table 16.13	Pump Details: Nkandla WTP Supply System .....	66
Table 16.14	Pipeline Details: Nkandla WTP Supply System .....	66
Table 16.15	Reservoir Details: Nkandla WTP Supply System .....	66
Table 16.16	Characteristics of the Middledrift WTP .....	72
Table 16.17	Pump Details: Middledrift WTP Supply .....	73
Table 16.18	Pipeline Details: Middledrift WTP Supply .....	73
Table 16.19	Reservoir Details: Middledrift WTP Supply .....	73
Table 16.20	Characteristics of the Greater Mthonjaneni WTP .....	77
Table 16.21	Pump Details: Greater Mthonjaneni WTP Supply .....	78
Table 16.22	Pipeline Details: Greater Mtonjaneni WTP Supply .....	78
Table 16.23	Reservoir Details: Goedertrouw WTP Supply .....	79
Table 16.24	Characteristics of the Eshowe WTP .....	82
Table 16.25	Pump Details: Eshowe WTP Supply .....	83
Table 16.26	Pipeline Details: Eshowe WTP Supply .....	83
Table 16.27	Reservoir Details: Eshowe WTP Supply .....	84
Table 16.28	Characteristics of the Ngwelezane WTP .....	87

Table 16.29 Pump Details: Ngwelezane WTP Supply .....	88
Table 16.30 Pipeline Details: Ngwelezane WTP Supply .....	88
Table 16.31 Reservoir Details: Ngwelezane WTP Supply.....	88
Table 16.32 Characteristics of the eSikhaleni WTP.....	91
Table 16.33 Pump Details: eSikhaleni WTP Supply.....	92
Table 16.34 Pipeline Details: eSikhaleni WTP Supply .....	92
Table 16.35 Reservoir Details: eSikhaleni WTP Supply .....	92
Table 16.36 Characteristics of the Nsezi WTP .....	95
Table 16.37 Pump Details: Nsezi WTP Supply.....	96
Table 16.38 Pipeline Details: Nsezi WTP Supply .....	96
Table 16.39 Reservoir Details: Nsezi WTP Supply.....	96
Table 16.40 Characteristics of the Mzingazi WTP .....	98
Table 16.41 Pump Details: Mzingazi WTP Supply .....	99
Table 16.42 Pipeline Details: Mzingazi WTP Supply .....	99
Table 16.43 Reservoir Details: Mzingazi WTP Supply .....	99
Table 16.48 WTP Scenarios in CoU (uMhlathuze Water 2016). .....	104
Table 16.49 Project information: Lower Thukela BWSS – Phase 3 .....	113

# LIST OF ACRONYMS

AADD	Annual Average Daily Demand
AC	Asbestos Cement
ADWF	Average Dry Weather Flow
API	Antecedent Precipitation Index
AVGF	Autonomous Valveless Gravity Filter
BID	Background Information Document
BPT	Break Pressure Tank
BWL	Bottom Water Level
BWSP	Bulk Water Services Provider
BWSS	Bulk Water Supply Scheme
CAPEX	Capital Expenditure
CMA	Catchment Management Agency
CoGTA	Department of Co-operative Governance and Traditional Affairs
CWSS	Community Water Supply and Sanitation project
DAEA	Department of Agriculture and Environmental Affairs
DEA	Department of Environmental Affairs
DEFF	Department of Environment, Forestry and Fisheries
DM	District Municipality
DRDLR	Department of Rural Development and Land Reform
DWA	Department of Water Affairs
DWS	Department of Water and Sanitation
DWAF	Department of Water Affairs and Forestry
EFR	Estuarine Flow Requirements
EIA	Environmental Impact Assessment
EKZN Wildlife	Ezemvelo KZN Wildlife
EMP	Environmental Management Plan
EWS	eThekwinini Water Services
EXCO	Executive Committee
FC	Fibre Cement
FL	Floor level
FSL	Full Supply level
GCM	General Circulation Model
GDP	Gross Domestic Product
GDPR	Gross Domestic Product of Region
GVA	Gross Value Added
HDI	Human Development Index
IDP	Integrated Development Plan
IFR	In-stream Flow Requirements
IMP	Infrastructure Master Plan
IRP	Integrated Resource Plan

ISP	Internal Strategic Perspective
IWRM	Integrated Water Resources Management
KZN	KwaZulu-Natal
LM	Local Municipality
LUMS	Land Use Management System
MA	Moving Average
MAP	Mean Annual Precipitation
MAR	Mean Annual Runoff
MBR	Membrane Bioreactor
MMTS	Mooi-Mgeni Transfer Scheme
MMTS-1	Mooi-Mgeni Transfer Scheme Phase 1
MMTS-2	Mooi-Mgeni Transfer Scheme Phase 2
mPVC	Modified Polyvinyl Chloride
MTEF	Medium-Term Expenditure Framework
MTSF	Medium-Term Strategic Framework
MWP	Mkomazi Water Project
MWP-1	Mkomazi Water Project Phase 1
NCP-1	North Coast Pipeline I
NCP-2	North Coast Pipeline II
NCSS	North Coast Supply System
NGS	Natal Group Sandstone
NPV	Net Present Value
NRW	Non-Revenue Water
NSDP	National Spatial Development Perspective
NWSP	National Water Sector Plan
OPEX	Operating Expenditure
p.a.	Per annum
PES	Present Ecological Status
PEST	Political, Economical, Sociological and Technological
PGDS	Provincial Growth and Development Strategy
PPDC	Provincial Planning and Development Commission (KZN's)
PSEDS	Provincial Spatial Economic Development Strategy
PWSP	Provincial Water Sector Plan
RDP	Reconstruction and Development Programme
RO	Reverse Osmosis
ROD	Record of Decision
RQO	Resource Quality Objective
SCA	South Coast Augmentation
SCP	South Coast Pipeline
SCP-1	South Coast Pipeline Phase 1
SCP-2a	South Coast Pipeline Phase 2a
SCP-2b	South Coast Pipeline Phase 2b

SDF	Spatial Development Framework
SHR	St Helen’s Rock (near Port Shepstone)
STEEPLE	Social/demographic, Technological, Economic, Environmental (Natural), Political, Legal and Ethical
SWRO	Seawater Reverse Osmosis
TEC	Target Ecological Category
TWL	Top Water Level
uPVC	Unplasticised Polyvinyl Chloride
UW	Umgeni Water
WA	Western Aqueduct
WC	Water Conservation
WDM	Water Demand Management
WMA	Water Management Area
WRC	Water Research Commission
WSA	Water Services Authority
WSDP	Water Services Development Plan
WSNIS	Water Services National Information System
WSP	Water Services Provider
WTP	Water Treatment Plant
WWW	Wastewater Works

Spellings of toponyms have been obtained from the Department of Arts and Culture (DAC). DAC provides the official spelling of place names and the spellings, together with the relevant gazette numbers, can be accessed at <http://www.dac.gov.za/content/toponymic-guidelines-map-and-other-editors>.

When using any part of this report as a reference, please cite as follows:

Umgeni Water, 2023. *Umgeni Water Infrastructure Master Plan 2023/2024 – 2053/2054, Vol 1 - 10*. Prepared by Planning Services, June 2023.

# LIST OF UNITS

<b>Length/Distance:</b>	mm	millimetre
	m	metre
	km	kilometre
<b>Area:</b>	m <sup>2</sup>	square metres
	ha	hectare
	km <sup>2</sup>	square kilometres
<b>Level/Altitude:</b>	mASL	metres above sea-level
<b>Time:</b>	s	second
	min	minute
	hr	hour
<b>Volume:</b>	m <sup>3</sup>	cubic metres
	Mℓ	megalitre
	million m <sup>3</sup>	million cubic metres
	mcm	million cubic metres
<b>Water Use/Consumption/Treatment/Yield:</b>	ℓ/c/day	litre per capita per day
	kℓ/day	kilolitre per day
	Mℓ/day	megalitre per day
	million m <sup>3</sup> /annum	million cubic metres per annum
	kg/hr	kilograms per hour
<b>Flow velocity/speed:</b>	m/s	metres per second
<b>Flow:</b>	m <sup>3</sup> /s	cubic metres per second
	ℓ/hr	litres per hour
	m <sup>3</sup> /hr	cubic metres per hour

## 15. MIDDLE uTHUKELA SYSTEM

### 15.1 Synopsis of the Middle uThukela System

The Middle uThukela region consists of the uThukela catchment between the Buffalo-uThukela confluence and the Woshi-uThukela confluence. The uThukela River meanders in a south-easterly direction, with the Mvoti Local Municipality (uMzinyathi WSA) located predominantly south of the uThukela River and the Nkandla Local Municipality (King Cetshwayo WSA) occupying the area north of the uThukela River (**Figure 15.1**).

Whilst the Nkandla Local Municipality has the largest area in the Middle uThukela region, the town of Nkandla is located approximately 1.4 km east of the Middle uThukela-uMhlathuze watershed. The settlements of Qudeni and Kranskop, however, are located on the Middle uThukela watershed: Qudeni on the Buffalo-Middle uThukela watershed and Kranskop on the Mvoti-Middle uThukela watershed. Settlements situated in the Middle uThukela region include Dlolwana, Jameson's Drift and The Ranch.

This region is home to the Thukela-Goedertrouw Transfer Scheme, an inter-basin transfer scheme where water is moved from the uThukela River to Goedertrouw Dam to improve the assurance of water supply to the Goedertrouw Regional Scheme supply area, including Richard's Bay, the largest port in Africa. The Thukela-Goedertrouw Transfer Scheme can also be supported by through releases from the Spioenkop Dam (uThukela DM), via the uThukela River, if necessary. Transfer from Spioenkop Dam usually commences when the Goedertrouw Dam's water level drops below 90% of its full supply capacity. The scheme was designed to pump approximately 1.2 m<sup>3</sup>/s from the uThukela River over the divide into the Goedertrouw Dam; however, only about 1.0 m<sup>3</sup>/s is transferred as a result of operational inefficiencies. Following the 2014/15 drought, the Thukela-Goedertrouw Transfer Scheme was redesigned to increase its capacity from 1.0 to 2.0 m<sup>3</sup>/s (UW, 2020). The construction phase of the upgrade project has been halted by contractual issues for a long period; however, construction works have recently resumed and the project is expected to be completed in 2023. This scheme is further discussed in **Section 16**.

The WTPs located in the Middle uThukela Region are summarised in **Table 15.1**.

**Table 15.1 WTPs located in the Middle uThukela Region (UAP Phase 3 2020: GIS Dataset).**

Scheme	Water Treatment Plant	Capacity (Mℓ/day)	Site
Vutshini-Nkandla	Mfongosi WTP	0.6	Manzawayo-Mfongosi confluence.
Vutshini-Nkandla	Khombe Hospital WTP	1	Upstream of tributaries flowing into the Vutshini River.
Makhabeleni	Makhabeleni WTP	4	uThukela River near Jameson's Drift.
Middledrift	Middledrift WTP	10	East of Ntolwane, on the banks of the Mkalazi, which flows westwards into the Nsuze
Ngcebo Water Supply Scheme	Ngcebo WTP	4	uThukela River near Middle uThukela-Lower uThukela watershed.



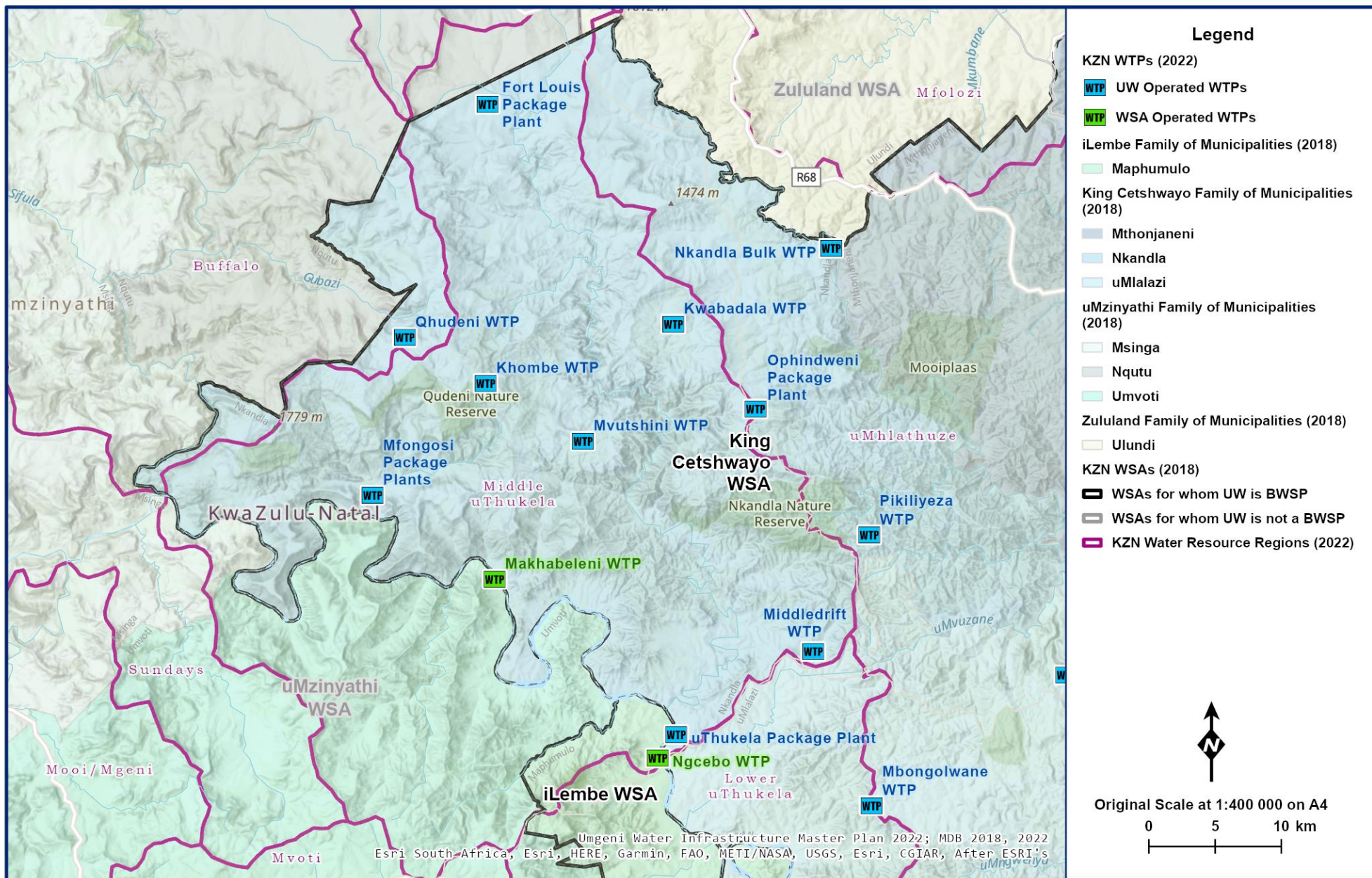

**Figure 15.1** General layout of the Middle uThukela Region.

The water supply schemes in this region are predominantly supplied from run-of-river abstraction infrastructure:

- Vutshini Nkandla Water Supply Scheme – this scheme sources its water from three river systems; (i) through run-of-river abstraction from the Vutshini Stream (a tributary of the Nsuze River); (ii) the Vove Dam in the Buffalo System (historical firm yield of 0.55 Mℓ/day) and (iii) the Mhlathuze River in the Mhlathuze System (yield of 1.34 Mℓ/day).
- The Makhabeleni Water Supply Scheme – this scheme is supplied from the uThukela River (yield of 1 Mℓ/day) near Jameson’s Drift.
- Middledrift Water Supply Scheme – this scheme is supplied from the Thukela-Goedertrouw Transfer scheme abstraction works (through the Madungela High Lift Pump) downstream of the uThukela-Nsuze confluence, with the water feeding various villages in the Middledrift Supply Area.
- Ngcebo Water Supply Scheme - raw water is abstracted at the Middledrift Abstraction works and is supplied via a raw water pipeline, across the river, to the Ngcebo WTP. From the treatment works, a bulk potable water rising main supplies a few reticulation reservoirs.

## 15.2 Water Resources of the Middle uThukela System

### 15.2.1 Description of the Middle uThukela System Water Resource Regions

#### (a) Middle Thukela Region

##### (i) Overview

As mentioned in **Section 15.1**, the uThukela River meanders in a south-easterly direction from the Buffalo-uThukela confluence, which is located approximately 1.9 km west of the Ntshongweni Hill, Trig Beacon 388, at an elevation of 1032.8 mASL (2830DA 1:50 000 Topographic Map 2013). Tributaries flowing from the north into the uThukela River include the:

- Mfongosi. The headwaters of the Mfongosi are located approximately 3.9 km north-west of Dlolwana and south-east of the Nkonyane Hill (Trig Beacon 413) in the Qudeni Nature Reserve. The Mfongosi flows in a south-westerly direction into the uThukela River (2830DB 1:50 000 Topographic Map 2013).

The Mfongosi WTP is positioned at the Manzawayo-Mfongosi confluence, approximately 2 km upstream of the Mfongosi-uThukela confluence (UAP Phase 3 2020: GIS dataset and 2830 DB 1:50 000 Topographic Map 2013).

- Manyane River, whose headwaters are located north-east of Dlolwana (2830DB 1:50 000 Topographic Map 2013) and flows in a southerly direction, passing the Isilokomane Mountain on the east and into the uThukela River at Jameson’s Drift (2830DD 1:50 000 Topographic Map 2013).
- Nsuze River, which sources its water from the Siphezi Hill (Trig Beacon 331 at 1547.6 mASL) (2830DB 1:50 000 Topographic Map 2013). The Nsuze River meanders in a southerly direction with tributaries including the Maxhuma, Mathole, Vutshini and Mkalazi, before it flows into

the uThukela River approximately 2.2 km downstream of the Shu Shu Warm Baths (2831CC 1:50 000 Topographic Map 2013). The Middledrift Pumping Scheme is approximately 1.1 km downstream of the uThukela-Nsuzi confluence.

The headwaters of the Vutshini are located approximately 2.9 km south-east of Qudeni as the crow flies. The Vutshini flows in a south-easterly direction into the Nsuzi River. The Khombe Hospital WTP, in the settlement of Spinnies, is located upstream of this tributary (2830DB 1:50 000 Topographic Map 2013).

The Middledrift WTP is located east of Ntolwane, on the banks of the Mkalazi River, which flows westwards into the Nsuzi River (2831CC 1:50 000 Topographic Map 2013). The capacity of the WTP is 10 Mℓ/day (UAP Phase 3 2020: GIS Dataset).

The proposed location for the Nsuzi WTP is on the Nsuzi River, south of the Sangeni settlement and between the Maxhuma-Nsuzi and Mathole-Nsuzi confluences (UAP Phase 3 2020: GIS dataset and 2830BD 1:50 000 Topographic Map 2013). The UAP Phase 3 further identified the capacity of the proposed Nsuzi WTP as 20 Mℓ/day (2020: GIS dataset).

Tributaries flowing into the uThukela River from the south include the Vamvule and the Ngcaza Rivers.

The Middle uThukela Region comprises of tertiary catchment V40 and quaternary catchment V60K. The most dominant land cover (**Figure 15.2**) category in this region is forestland and grassland, occupying 50% and 27% of the entire region respectively.

## (ii) Surface Water

The hydrological characteristics for this region are summarised in **Table 15.2**.

**Table 15.2 Hydrological characteristics of the Middle Thukela Region (WR90, WR2012: Thukela Quat Info WMA 7 7Jul2015 spreadsheet)**

Region	River (Catchment)	Area (km <sup>2</sup> )	Annual Average			
			Evaporation (mm)	Rainfall (mm)	Natural Runoff (million m <sup>3</sup> )	Natural Runoff (mm)
Middle Thukela	Thukela River (V40)	1 753	1 415	817	159.2	90.8
	Thukela River (V60K)	228	1 400	691	13.0	57.1
	<b>Total</b>	<b>1 981</b>				

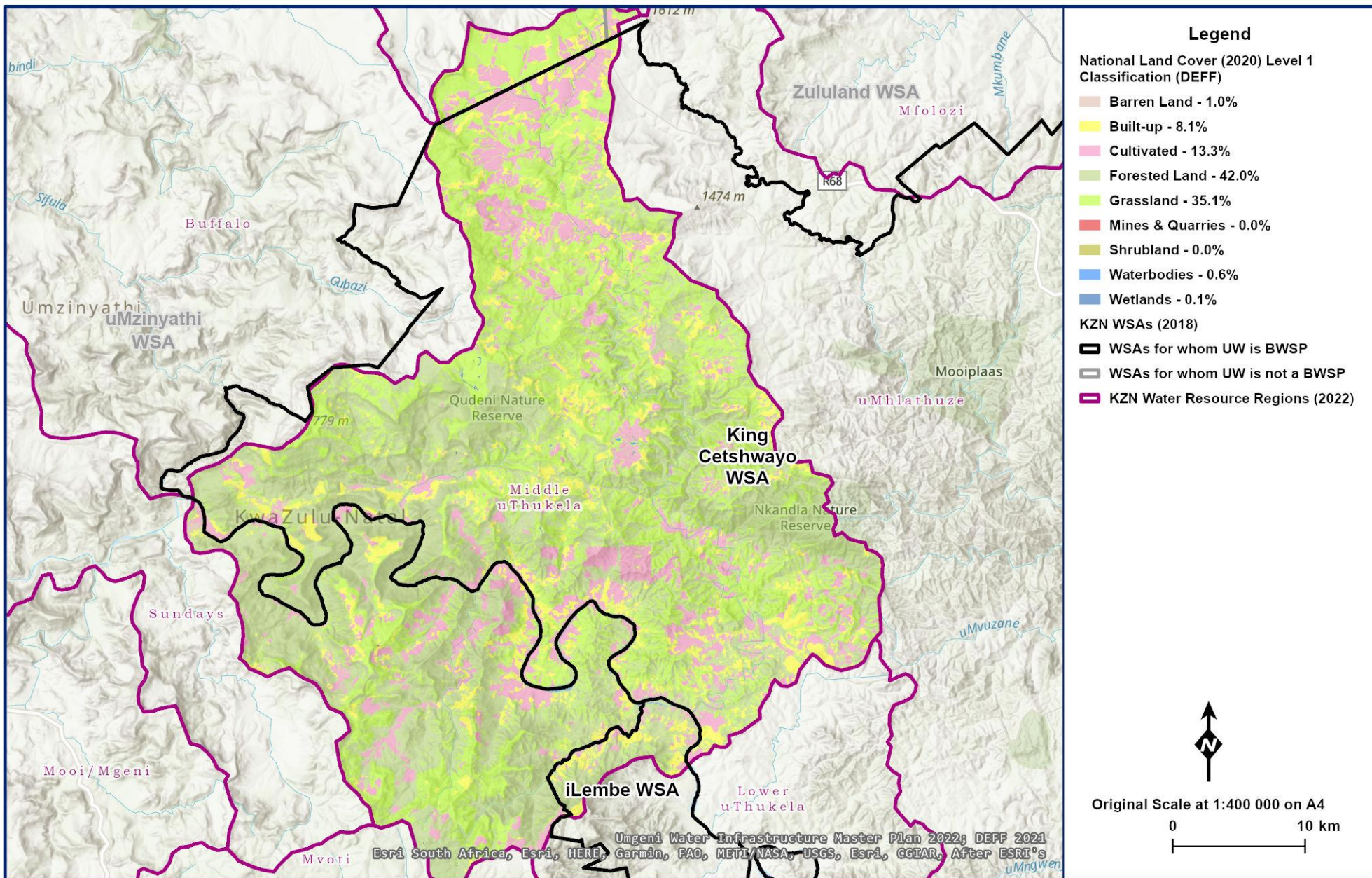

Figure 15.2 Middle uThukela land cover (DEFF 2020, MDB 2020, Umgeni Water 2022, WR2012).

### **(iii) Groundwater**

The Middle uThukela region is located in two hydrogeological regions, the KwaZulu-Natal Coastal Foreland and North Eastern Middleveld (DWAF 2008) (**Figure 15.3**).

#### **• Hydrogeological Units**

Basement rocks are exposed mainly in the northern parts of the area, comprising granite-gneiss, schists and amphibolites.

The outcrop of Dwyka Group Tillite is prevalent around Kranskop and Qudeni. Sediments of the Ecca Group are found in the eastern part of the area, with rocks of the Vryheid Formation underlying much of the area. These rocks mainly comprise sandstones and are relatively resistant to erosion, resulting in relatively narrow and deeply incised river channels.

All the above sedimentary strata have been extensively intruded by dykes and sills of dolerite. These features play an important role in the geohydrology of the area, and significantly enhance the water-bearing properties of aquifers in the area.

The Natal Metamorphic Province includes rocks of some 1000 Ma, but their extent is limited to the south-eastern part of the catchment around Kranskop. The extent of the Natal Group is also limited to the area east of Kranskop.

#### **• Geohydrology**

The study area is mostly underlain by the Karoo Supergroup and is either sub-horizontal or has a very gentle inland dip to the west, wherein the structure comprises numerous south-easterly tilted fault blocks. These fault blocks play an important role in groundwater flow. Aquifers within the study area include:

- Weathered and fractured hard rock aquifer systems.
- Primary aquifers that are confined to a narrow strip along the middle reaches of the uThukela, Sundays and Buffalo Rivers.

#### **• Groundwater Potential**

Groundwater yields from 'hard-rock' boreholes in the area are generally low and in the range 0.1 to 0.6 *l/s*, although significantly higher yields (3 *l/s*) can be obtained in hydrogeologically favourable situations, such as fracturing and intrusive Karoo dolerite contact zones. Contacts between different lithologies were also seen to be important drilling targets. There is little difference in yield among the various geological formations. Higher borehole yields can be obtained in some localities. Juxtaposition of sandstone horizons to dolerite, major structural features such as faults and fractures and more competent Natal Group quartzites and sandstones have produced borehole yields in excess of 2 *l/s*. The likelihood of obtaining yields in excess of 2 *l/s*, however, is less than 30%, while few boreholes yield more than 3 *l/s*. Groundwater recharge over the area varies from 1 to 5 % of the mean annual precipitation (MAP), with an average of about 3 percent of the MAP.

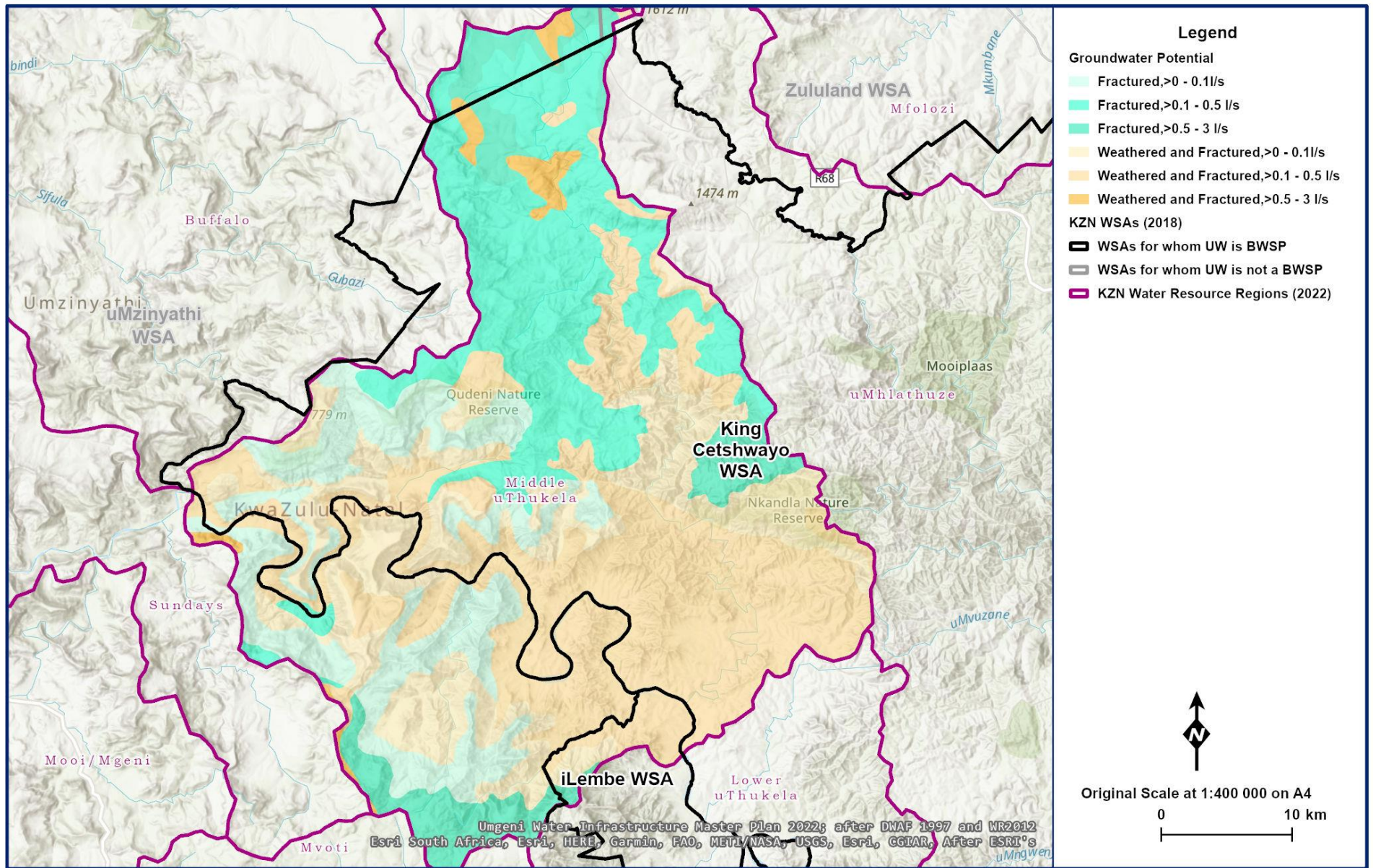

**Figure 15.3** Groundwater potential in the Middle Thukela Region (MDB 2020, Umgeni Water 2022, after DWAF 1997 and WR2012).

#### (iv) Water Quality

- **Surface Water**

There are no known major water quality problems in the Vutshini Water Supply Scheme area. It is, however, likely that the quality of the Vutshini River is significantly affected during periods of low flow due to the land use activities upstream and soil erosion (Department of Water Affairs Vutshini All Town Study, 2011, Page23).

- **Groundwater**

Groundwater quality in the area is generally good, with the best quality groundwater found in the higher rainfall portions, and the poorest quality in the lower rainfall areas towards the east, groundwater quality deteriorates in the direction of flow and assumes a more dominant N-Cl character. The total dissolved solid (TDS) content of the groundwater is generally in the range 50 to 200 mg/l, but this can rise considerably to more than 420 mg/l in the lower rainfall portions. Poorer quality groundwater is found in the lower reaches of the Upper uThukela, Bushmans and Mooi Catchments, probably reflecting the influence of the argillaceous sediments in this part of the study area. Instances of elevated fluoride were reported for the western part of the catchment.

### 15.2.2 Reserve

In February 2020, the Department of Water and Sanitation commissioned a study entitled *Determination of Water Resource Classes and Associated Resource Quality Objectives in the Thukela Catchment*. The determination of water resource classes is an important process for sustainable water resources management as it provides guidelines to ensure that a balance is established between the need to develop and use water resources on one hand, against the need to preserve and protect the resource on the other. The study is guided by stakeholder participation and engagement through various platforms such as public meetings and a Project Steering Committee. The study was completed in June 2021 (DWS, 2021) and a final Gazette for the Water Resource Classes and Associated Resource Quality Objectives (RQOs) was issued in March 2023.

This section summarises the key findings from the study, with a focus on the middle uThukela water resource region. Of particular interest, from a water resources management perspective, is the present ecological state (PES) and the recommended or targeted ecological state (TEC) of water resources in the region.

The Water Resource Classes and Associated Resource Quality Objectives report categorises the study area into different integrated units of analysis (IUAs), based on various factors, including the homogeneity of climate, soils and land use. For the purpose of this report, the middle uThukela water region falls within two IUAs: (i) Quaternary catchments V40A and B are grouped into one integrated unit of analysis (IUA), forming part of the area downstream of the Mooi River confluence to the Middeldrift-Goudertrouw Transfer Scheme pump station and (ii) the uThukela River from the Middeldrift-Goudertrouw Transfer Scheme abstraction point to the Lower Thukela Bulk Water Supply Scheme abstraction point. The water resources classes and associated resources quality objectives for these two IUAs are shown in **Table 15.3** below.

**Table 15.3 The present and targeted ecological state of water resources within the Middle uThukela Water Resource Region (DWS, 2023).**

IUA Description	PES	TEC
Mooi River confluence to the Middledrift-Goudertrouw Transfer Scheme pump station	The present ecological state (PES) of this IUA is category C with significant modification due to subsistence agriculture in the rural settlements, as well as pumping of water to the uMhlathuze River catchment via the Middledrift-Goudertrouw Transfer Scheme.	The targeted ecological state (TEC) for this IUA (V40A &B) is category C, where it is recommended that base flow patterns are maintained to sustain low flows and river health during drought periods.
The uThukela River from the Middledrift-Goudertrouw Transfer Scheme abstraction point to the Lower Thukela Bulk Water Supply Scheme (LTBWSS) abstraction point.	The PES of the main stem is currently category B, as the amount of villages and subsistence agriculture are less significant along the river.	The TEC for this region is category C due to the expected continuation and increasing in the amount of water pumped out of the river through the LTBWSS. It is recommended that both low/base flows during winter and high flows (or freshets) during summer are maintained to sustain riverine ecology and water quality.

The DWAF (2004) “Thukela Reserve Determination Study” was an informant to the uThukela ISP, which reported that:

- The uThukela Reserve water resource analysis assumed that the Spioenkop, Ntshingwayo and Wagendrift Dams will all contribute to the users and the Reserve in the Middle to Lower uThukela areas. This conjunctive use of these three dams results in large theoretical surpluses in the Lower uThukela.

### 15.2.3 Existing Water Resource Infrastructure and Yields

The Vutshini and Nkandla supply areas were combined into a single supply area so as to shift the supply area boundary eastwards, incorporating the Nsuzi River as a sustainable supply source. The water supply area covers the north-western section of the Nkandla Local Municipality, within King Cetshwayo District Municipality (UThungulu DM, 2015, Page 3).

The Vutshini-Nkandla Regional Scheme is the main water supply scheme in this region and is described below:

- The Nkandla Water Supply Scheme area straddles the Upper Mhlathuze River (i.e. quaternary catchment W12A) and the Nsuzi River catchments (i.e. Quaternary Catchments V40C & D). There is a current deficit of 0.38 million m<sup>3</sup>/a (1.0 Mℓ/day) on the registered water use for the Nkandla Water Supply Scheme. The water supply deficit will continue to increase to 1.91 million m<sup>3</sup>/a (5.2 Mℓ/day) by 2030 on the high growth scenario. The available water resources of 1.65 million m<sup>3</sup>/a (4.5 Mℓ/day) are not sufficient to meet the current and future water requirements of the Nkandla Water Supply Scheme Area, particularly during low flow periods (DWAF, 2011).
- The Vutshini Water Supply Scheme utilises the uThukela River as its main source (1 Mℓ/day) and the Vutshini River, which is a tributary of the Nsuzi River, as an alternate source. The scheme also receives its water from Vove Dam (yield of 0.55 Mℓ/day) on the Vove River and



the Mhlathuze River (yield of 1.34 Mℓ/day). The Vutshini Water Supply Scheme comprises of two WTPs. Only one plant falls within this region, namely, the Vutshini WTP at the Vutshini Village. The WTP supplies the village and the surrounding villages up to Msobotsheni in the north-east and Ntingwe in the south (Department of Water Affairs, 2011, page 17). The Ntingwe Dam (**Figure 15.4** and **Table 15.5**) supplies raw water for both irrigation and domestic water supply purposes to the Ntingwe rural community.

During low flow periods, the maximum abstraction over a 3-month period at the Vutshini WTP is approximately 0.03 million m<sup>3</sup>. This amount is not sufficient to meet the 3-month peak summer demand of 0.39 million m<sup>3</sup> (Department of Water Affairs All Town study, 2011, Page 22).

Dams found in this region include the Ntingwe Masonry and Ntingwe Dams which are being used as irrigation dams in the Ntingwe Tea Estate. During dry periods there is insufficient water in the Lower uThukela River and releases from upstream dams are needed.

A dam on the Nsuze River is recommended to supply the future demand of the Vutshini-Nkandla regional scheme. Preliminary hydrological investigations indicate that a dam impounding 31 million m<sup>3</sup> will have an estimated yield of 19 Mℓ/day for the scheme (UAP Phase 3, 2020).

The other scheme in this region is the Kranskop Water Supply Scheme which is currently supplied by groundwater abstraction. The nearest river is the Mandleni River which is part of the uThukela River system.

Other small treatment works exist in this area but are not reported on here as they don't constitute bulk schemes. These are either supplied from run-of-river abstractions or boreholes (Department of Water Affairs All Town study, 2011, Page 22).

The water supply area showing the respective sources of supply is presented in **Table 15.4**.

**Table 15.4 Supply Area and their respective water sources (Umgeni Water, 2019: 17)**

Scheme supply Area	Local Municipality	Source
Vutshini-Nkandla	Nkandla	Nsuze River, uThukela River

## 15.2.4 Operating Rules

The Ntingwe Dam (**Figure 15.4** and **Table 15.5**) is used solely to support irrigation needs. As a result, there are no operating rules presented for Ntingwe Dam in this report.



Figure 15.4 Ntingwe Dam (MBB Consulting Engineers 2020: website).

**Table 15.5 Characteristics of Ntingwe Dam.**

<b>Catchment Details</b>	
<b>Incremental Catchment Area:</b>	1.03 km <sup>2</sup> <sup>a</sup>
<b>Total Catchment Area:</b>	5 km <sup>2</sup> <sup>a</sup>
<b>Mean Annual Precipitation:</b>	810 mm <sup>b</sup>
<b>Mean Annual Runoff:</b>	0.21 million m <sup>3</sup> <sup>b</sup>
<b>Annual Evaporation:</b>	1400 mm <sup>b</sup>
<b>Dam Characteristics</b>	
<b>Gauge Plate Zero:</b>	943.5 mASL <sup>e</sup>
<b>Full Supply Level:</b>	960 mASL <sup>e</sup>
<b>Net Full Supply Capacity:</b>	0.4 million m <sup>3</sup> <sup>c</sup>
<b>Spillway Height:</b>	16.5 m <sup>c</sup>
<b>Dead Storage:</b>	N/A
<b>Total Capacity:</b>	0.4 million m <sup>3</sup> <sup>c</sup>
<b>Original Measured Dam Capacity:</b>	0.4 million m <sup>3</sup> <sup>c</sup>
<b>Surface Area of Dam at Full Supply Level:</b>	0.07 km <sup>2</sup> <sup>c</sup>
<b>Dam Type:</b>	Earth fill <sup>c</sup>
<b>Material Content of Dam Wall:</b>	Earth fill <sup>c</sup>
<b>Crest Length:</b>	Crest length: 134 m <sup>c</sup> Spillway Section: 24 m <sup>d</sup> Non-Spillway Section: 110 m <sup>d</sup>
<b>Type of Spillway:</b>	Side Channel Spillway <sup>c</sup>
<b>Capacity of Spillway:</b>	N/A
<b>Date of Completion:</b>	2001 <sup>c</sup>
<b>Date of Last Area Capacity Survey:</b>	2009 <sup>c</sup>
<b>Date of Next Area Capacity Survey:</b>	N/A

<sup>a</sup> Catchment delineation using 20m DEM and spatial analyst.

<sup>b</sup> WR2012

<sup>c</sup> DWS List of Registered Dams Database (April 2019).

<sup>d</sup> Measured on Google Earth.

<sup>e</sup> 0.5m Contours

## 15.3 Supply Systems

### 15.3.1 Description of the Middle uThukela System

The Middle uThukela System includes supply to two major areas including those south of the uThukela River in uMzinyathi DM and those north of the uThukela River in King Cetshwayo DM (KCDM), including the City of uMhlathuze WSA. Supply to the King Cetshwayo areas is predominantly from water abstracted at Middledrift through the Middledrift-Goedertrouw Transfer Scheme. Information on KCDM systems is reported on the Mhlathuze System (**Section 16**). Supply to the uMzinyathi Area is described below.

#### (a) Makhabeleni WTP and Supply System

The Makhabeleni WTP is located in Makhabeleni (Jameson's Drift) along the uThukela River in the uMzinyathi District Municipality.

Makhabeleni WTP obtains its raw water from the uThukela River and pumped via an abstraction tower and bridge to a 4 Mℓ/day WTP on the southern banks of the uThukela River. At the WTP, raw water is treated and pumped to a high level command reservoir before being distributed to various reservoirs in different parts of Makhabeleni.

The WTP was upgraded from 2 Mℓ/day to 4 Mℓ/day towards the end of 2017 and five phases of the distribution network were completed towards the end of 2018. A portion of the sixth phase of the distribution system was also completed in 2018.

The spatial layout of the completed phases 1 to 5, a portion of phase 6 and the planned phases 7 and 8 are shown in **Figure 15.5** and the schematic is illustrated in **Figure 15.6**.

The characteristics of the Makhabeleni WTP are shown in **Table 15.6**. The pump details, reservoir details and pipeline details are listed in **Table 15.7**, **Table 15.8** and **Table 15.9** respectively.

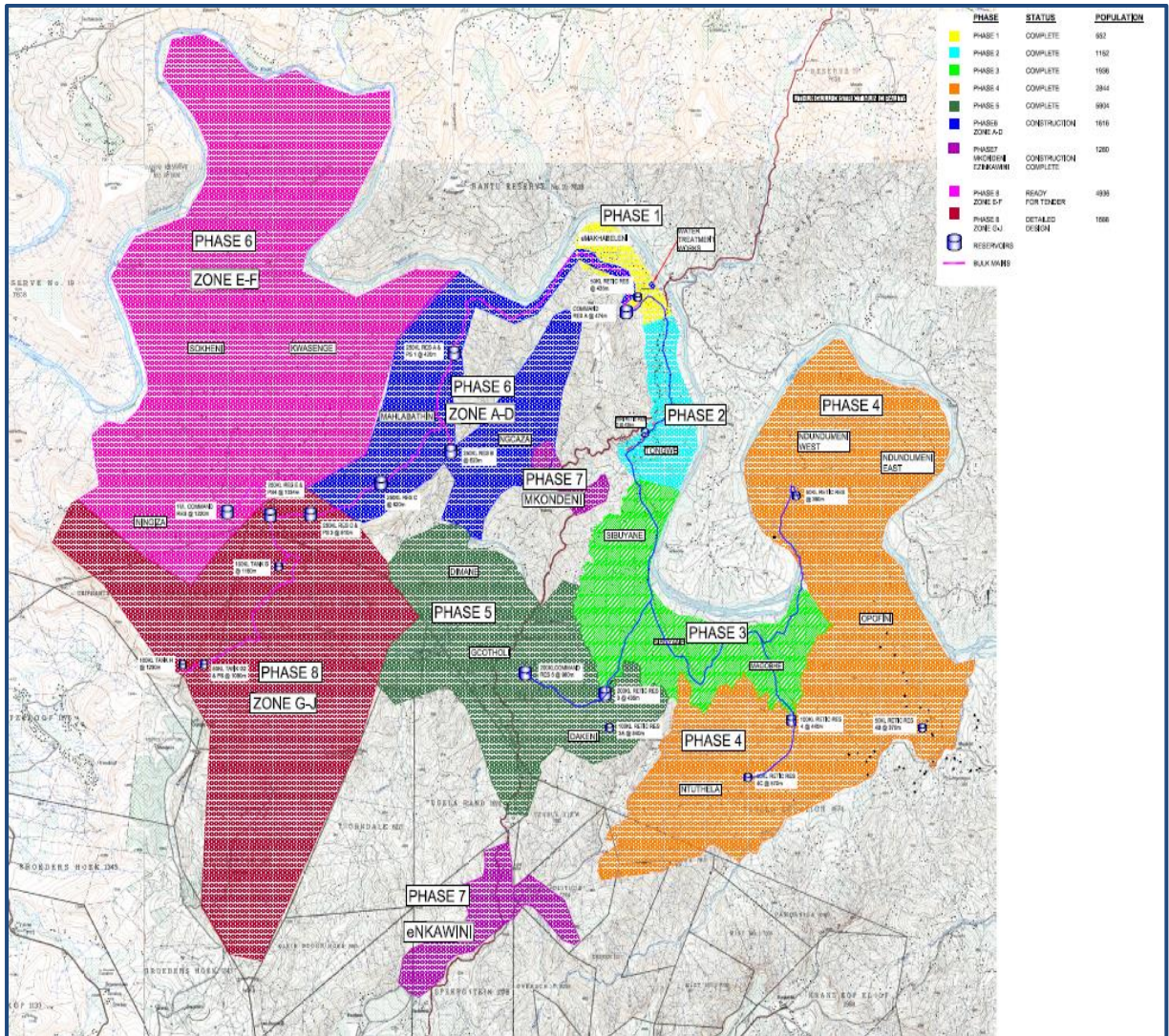

Figure 15.5 Spatial layout of the Makhabeleni Supply System.

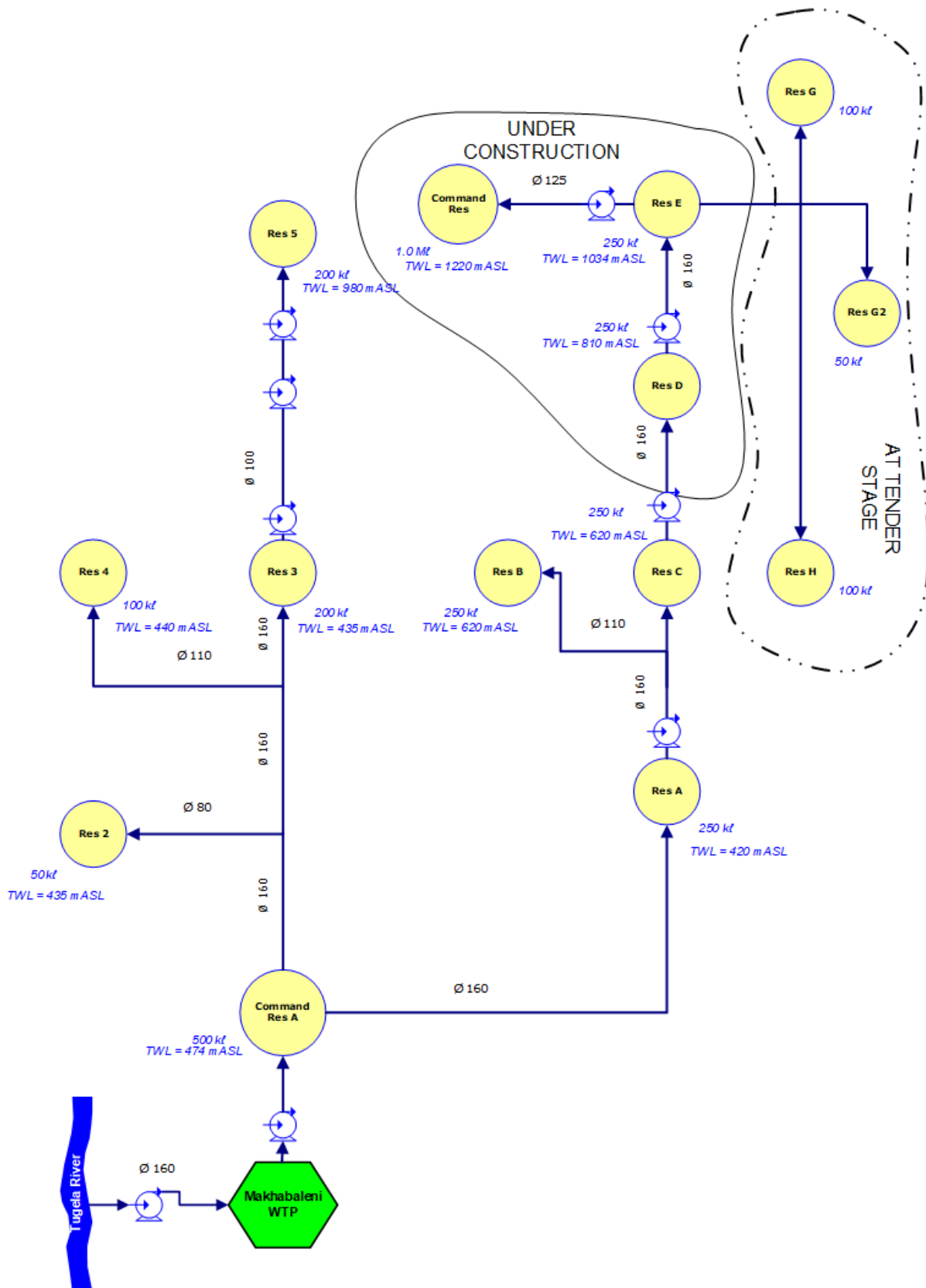

Figure 15.6 Schematic of the Makhabeleni Supply System.

**Table 15.6 Characteristics of the Makhabeleni WTP.**

<b>WTP Name:</b>	Makhabeleni WTP
<b>System:</b>	Tugela Supply System
<b>Maximum Design Capacity:</b>	4 Mℓ/day
<b>Current Utilisation:</b>	2.0 Mℓ/day
<b>Raw Water Storage Capacity:</b>	0 Mℓ
<b>Raw Water Supply Capacity:</b>	2.0 Mℓ/day due to constraint of abstraction works
<b>Pre-Oxidation Type:</b>	None
<b>Primary Water Pre-Treatment Chemical:</b>	Polymeric Coagulant
<b>Total Coagulant Dosing Capacity:</b>	13 ℓ/hour (running at 50%)
<b>Rapid Mixing Method:</b>	Conventional Paddle Flash Mixer
<b>Clarifier Type:</b>	Dortmund manual clarifiers
<b>Number of Clarifiers:</b>	6 (2 old and 4 new)
<b>Total Area of all Clarifiers:</b>	140.4 m <sup>2</sup> (28.08 m <sup>2</sup> old and 112.32 m <sup>2</sup> New)
<b>Total Capacity of Clarifiers:</b>	4.5 Mℓ/day
<b>Filter Type:</b>	Constant Rate Rapid Gravity Filters
<b>Number of Filters:</b>	8 (2 Old and 6 New)
<b>Filter Floor Type</b>	Laterals with Nozzles
<b>Total Filtration Area of all Filters</b>	83.64 m <sup>2</sup>
<b>Total Filtration Design Capacity of all Filters:</b>	4 Mℓ/day
<b>Total Capacity of Backwash Water Tanks:</b>	0m <sup>3</sup>
<b>Total Capacity of Sludge Treatment Plant:</b>	None
<b>Capacity of Used Washwater System:</b>	0 Mℓ/day
<b>Primary Post Disinfection Type:</b>	Sodium Hypochloride
<b>Disinfection Dosing Capacity:</b>	13 ℓ NaOCl/hr
<b>Disinfectant Storage Capacity:</b>	
<b>Total Treated Water Storage Capacity:</b>	0.5 Mℓ

**Table 15.7 Pump details: Makhabeleni Supply System.**

System	Pump Station Name	Number of Pumps		Pump Description	Supply From	Supply To	Static Head (m)	Duty Head (m)	Duty Capacity (ML/day)
		Number of Duty Pumps	Number of Standby Pumps						
Makhabeleni	Raw Water (WTP)	1	1	(Was KSB ELK 40) Ops replaced with Gorman Rupp	Tugela Abstraction	Makhabeleni WTP Pre-settlement Tank	32.8	35.23	4.24
Makhabeleni	Potable Water High Lift (WTP) (Umzinyathi)	2	1	KSB WKLn 65/6	WTP	Command Reservoir	166.1	194	2.0
Makhabeleni	Potable Water High Lift (WTP) B (Uthungulu)	2	1	KSB WKLn 65/6	WTP	Uthungulu Reservoir	192.8	217	2.0
Makhabeleni	Phase 4	1	1	Grundfos CR 3-31	Ph4 Res 4 Bulk	Res 4 C	135	160	0.125
Makhabeleni	Phase 5 (Lift 1A)	1	1	TBC	Ph3 Reservoir	Tank 2	201	222	0.48
Makhabeleni	Phase 5 (Lift 1B)	1	1	TBC	Ph3 Reservoir	Dakeni Res 3b	122	137	0.107
Makhabeleni	Phase 5 (Lift 2)	1	1	TBC	Tank 2	Tank 3	169	189	0.48
Makhabeleni	Phase 5 (Lift 3)	1	1	TBC	Tank 3	Ph 5 Command Res	190	210	0.48
Makhabeleni	Phase 6 (Lift 1A)	1	1	Grundfos CR 5-36	Res 6A	Res 6B	190.4	234	0.099
Makhabeleni	Phase 6 (Lift 1B)	1	1	Grundfos CR 45-10	Res 6A	Res 6C	188.7	255.5	0.828
Makhabeleni	Phase 6 (Lift 2)	1	1	Grundfos CR 45-10	Res 6C	Res 6D	207.1	232.8	0.810
Makhabeleni	Phase 6 (Lift 3)	1	1	Grundfos CR45-11	Res 6D	Res 6E	226.4	247.7	0.764
Makhabeleni	Phase 6 (Lift 4A)	1	1	Grundfos CR32-14	Res 6E	Res 6F (Command)	206.1	221.8	0.642
Makhabeleni	Phase 6 (Lift 4B)	1	1	TBC	Res 6E	Res G1 (future)	132.8	154.5	0.316
Makhabeleni	Phase 6 (Lift 5)	1	1	Grundfos CRE1-27	Tank F1	Tank F2 (under construction)	100	106	0.023
Makhabeleni	Ph 7 (Ezinkawini)	1	1	Grundfos CRE 10-17	Tank E1	Tank E2	224	245.4	0.171
Makhabeleni	Ph 7 (Mkondeni)	1	1	Grundfos CR 5-36	Tank M1	Tank M2	199	214	0.071



**Table 15.8 Reservoir details: Makhabeleni BWSS.**

System	Reservoir Site	Reservoir Name	Capacity (Mℓ)	Function	TWL (m ASL)	FL (m ASL)
Makhabeleni	Makhabeleni	Command Res A	0.500	Distribution	474	468#
Makhabeleni	Makhabeleni	Res 2	0.050	Terminal	435	429#
Makhabeleni	Makhabeleni	Res 3	0.200	Distribution	435	431#
Makhabeleni	Makhabeleni	Res 4	0.100	Distribution	440	436#
Makhabeleni	Makhabeleni	Res 5	0.200	Terminal	980	976#
Makhabeleni	Makhabeleni	Res A	0.250	Distribution	420	416#
Makhabeleni	Makhabeleni	Res B	0.250	Terminal	620	615#
Makhabeleni	Makhabeleni	Res C*	0.250	Distribution	620	615#
Makhabeleni	Makhabeleni	Res D*	0.250	Distribution	810	805#
Makhabeleni	Makhabeleni	Res E*	0.250	Distribution	1034	1030#
Makhabeleni	Makhabeleni	Res G**	0.100	Terminal	1160	1155#
Makhabeleni	Makhabeleni	Res G2**	0.050	Terminal	1090	1085#
Makhabeleni	Makhabeleni	Res H**	0.100	Terminal	1230	1225#
Makhabeleni	Makhabeleni	Res F**	1.0	Distribution	1230	1225#

\*Under construction (anticipated completion is end 2020); \*\*At tender stage; #Based on assumed reservoir depth

**Table 15.9 Pipeline details: Makhabeleni BWSS.**

System	Pipeline Name	From	To	Length (km)	Nominal Diameter (mm)	Material	Capacity (Ml/day)	Age (years)
Makhabeleni	Raw water pipeline	Abstraction works	Makhabeleni WTP	0.127	160	uPVC	2.6**	6
Makhabeleni	Potable water pipeline	Makhabeleni WTP	Command Res A	0.947	160	uPVC	2.6**	6
Makhabeleni	Potable water pipeline	Command Res A	Res 2	4.652	160	uPVC	2.6**	6
Makhabeleni	Potable water pipeline	Command Res A	Res 3	11.91	160	uPVC/HDPE	2.6**	6
Makhabeleni	Potable water pipeline	Res 3	Res 5	2.916	100	Klambon	1.02**	6
Makhabeleni	Potable water pipeline	Command Res A	Res 4	16.617	160/110	uPVC	1.23**	6
Makhabeleni	Potable water pipeline	Command Res A	Res A	8.556	160	uPVC	2.6**	6
Makhabeleni	Potable water pipeline	Res A	Res B	2.983	110/75	uPVC/HDPE	0.572**	6
Makhabeleni	Potable water pipeline	Res A	Res C	4.165	110	uPVC	1.23**	6
Makhabeleni	Potable water pipeline	Res C	Res D	2.393	125	uPVC	1.59**	6
Makhabeleni	Potable water pipeline	Res D	Res E	1.196	125	uPVC	1.59**	1
Makhabeleni	Potable water pipeline	Res E	Res F	1.730	125	Steel	1.59**	1
Makhabeleni	Potable water pipeline	Res E	Res G	1.162	110	HDPE	1.23**	Planned
Makhabeleni	Potable water pipeline	Res E	Res G2	5.553	110	HDPE	1.23**	Planned
Makhabeleni	Potable water pipeline	Res G2	Res H	1.080	110	HDPE	1.23**	Planned

\* Based on a velocity of 2 m/s      \*\* Based on a velocity of 1.5 m/s      # Age need to be verified

## 15.3.2 Status Quo and Limitations of the Middle uThukela System

### (a) Makhabeleni WTP and Supply System

The Makhabeleni BWSS has recently been upgraded and is adequate to meet current and future demand. The main challenge facing the WTP is limited raw water abstraction capacity (currently limited to 2 Mℓ/day). It is proposed that a feasibility study be undertaken to investigate the potential for an upgrade of the abstraction works to cater for both current and future demands.

## 15.4 Water Balance/Availability

The Vutshini-Nkandla Regional Water Supply Scheme is mainly supplied from run-of-river abstractions through the Vutshini Stream and the Vove Dam (yield of 0.55 Mℓ/day), Mhlathuze River (yield of 1.34 Mℓ/day) and uThukela River (yield of 1 Mℓ/day). The source yield will be insufficient to cater for the requirements of the Vutshini-Nkandla Scheme.

A dam on the Nsuzi River is recommended to supply the future demand of the Vutshini-Nkandla regional scheme, the preliminary hydrological investigations indicate that a dam impounding 31 Million m<sup>3</sup> will have a sufficient yield of 19 Mℓ/day for the scheme (UAP Phase 3, 2020).

## 15.5 Recommendations for the Middle uThukela System

### 15.5.1 System Components

#### (a) Ngcebo WTP and Supply System

The Ngcebo Bulk Water Supply Scheme is located in the far northern reaches of the Maphumulo Local Municipality, along the Mzinyathi-KCDM border. This bulk water supply scheme obtains its raw water supply via the Madungela Abstraction Works, which sources its water from the uThukela River. Raw water is pumped to the Ngcebo WTP via a bulk water pipeline where it is treated, then distributed to areas north and south of the WTP.

The Ngcebo Water Supply System (WSS) was implemented in five phases by Umgeni Water, with the first phase completed in June 2008 supplying an estimated population of 6 104. Phase 1 also included the upgrade of the Ngcebo WTP to 0.25 Mℓ/day, as well as the implementation of a reticulation system.

Phase 2 and Phase 3 entailed the construction of reticulation to supply an additional estimated population of 7 128 and were completed in December 2008 and June 2009, respectively. Umgeni Water then implemented an upgrade of existing bulk pipelines and an upgrade of the WTP to 0.43 Mℓ/day before implementation of Phase 4 could take place.

Phase 4 consisted of newly laid reticulation pipelines to supply a population of approximately 2 168, and was completed in April 2010. By January 2012, Umgeni Water had then completed the upgrade of the

raw water bulk pipeline from the Madungela Abstraction Works to increase the supply of raw water to the Ngcebo WTP.

In October 2013, Phase 5 of the Ngcebo BWSS was completed, ultimately providing water to an additional population of approximately 1 656. The Ngcebo WTP has recently undergone a capacity upgrade to 4 Mℓ/day in order to provide a consistent supply of water to all households within the area.

The Universal Access Plan Phase III planning study (Umgeni Water 2020) identified the following upgrades and augmentation required to adequately supply the Ngcebo WSS:

- The bulk distribution infrastructure is to be extended to include three (3) primary bulk pipes of diameter ranging between 63 – 315 mm, totalling 6.04 km in length, 17 secondary bulk pipes ranging in diameter of between 110 - 630 mm, totalling 50.04 km in length and 21 tertiary bulk pipes ranging in diameter between 50 – 125 mm, totalling 21.48 km in length
- Increase the existing storage capacity by constructing two (2) primary reservoirs, having a total storage capacity of 800 kℓ and 25 tertiary reservoirs, having a total storage capacity of 8 220 kℓ
- Construction of one 15.51 kW pump station to serve the primary command reservoir

The total bulk cost requirement for the Ngcebo BWSS is R250.8 million (excl VAT).

## REFERENCES

Department of Water Affairs. 2010. Water Supply and Drought Operating Rules for Stand-Alone Dams and Schemes Typical of Rural/Small Municipal Water Supply Schemes: Eastern Cluster. Prepared by BKS (Pty) Ltd. Department of Water Affairs: Pretoria.

Department of Water Affairs. 2011. *UThungulu District Municipality: Reconciliation Strategy for the Vutshini Water Supply Scheme Area – Nkandla Local Municipality*. Prepared by Water for Africa (Pty) Ltd in association with Aurecon (Pty) Ltd; Water Geosciences and Charles Sellick and Associates. Department of Water Affairs: Pretoria.

Department of Water Affairs. 2021. *Determination of Water Resource Classes and Associated Resources Quality Objectives in the Thukela catchment - Draft Resource Quality Objectives and Numerical Limits Report*. WP 11255. Study Report No. RDM/WMA04/00/CON/CLA/0221, Department of Water Affairs: Pretoria.

Department of Water Affairs. 2011. *UThungulu District Municipality: Reconciliation Strategy for the Nkandla Water Supply Scheme Area – Nkandla Local Municipality*. Prepared by Water for Africa (Pty) Ltd and Department of Water Affairs: Pretoria.

Umgeni Water. 2019. *Universal Access Plan Phase iii – Progressive Development of a Regional Concept Secondary Bulk Water Master Plan for The King Cetshwayo District Municipality*. Prepared by Mariswe (Pty) Ltd. Umgeni Water: Pietermaritzburg.

Umgeni Water. 2020. *Universal Access Plan Phase iii – Progressive Development of a Regional Concept Secondary Bulk Water Master Plan for The King Cetshwayo District Municipality*. Prepared by Mariswe (Pty) Ltd. Umgeni Water: Pietermaritzburg

UThungulu District Municipality. 2015. *Master Plan Vutshini Nkandla Regional Scheme 2015 Revision*. Prepared by AECOM SA (Pty) Ltd. UThungulu District Municipality: Richards Bay.

## 16. UMHLATHUZE SYSTEM

---

### 16.1 Synopsis of the uMhlathuze System

With a total catchment area of approximately 5 653 km<sup>2</sup> (WR2012 Secondary Catchments GIS Dataset), the uMhlathuze Water Resource Region (W1 secondary catchment) is composed of the uMhlathuze River (W12 tertiary catchment), Mlalazi River (W13 tertiary catchment) and Matigulu River (W11 tertiary catchment) catchments (**Figure 16.1**). Four Water Service Authorities (WSAs) are located in the uMhlathuze Water Resource Region (**Figure 16.1**):

- i) A small portion of the Zululand WSA is located in the north-west of the uMhlathuze Region.
- ii) The King Cetshwayo District Municipality (KCDM) WSA.
- iii) The City of uMhlathuze WSA (although geographically part of KCDM).
- iv) The northern portion of the iLembe WSA, which is located in the Matigulu portion of the uMhlathuze Resource Region.

The headwaters of the uMhlathuze River are located approximately 0.4 km from the Zululand-King Cetshwayo District Municipal boundary<sup>1</sup> (2830BD 1:50 000 Topographic Map 2013), approximately 1.8 km south-west of the Babanango Hill (Trig Beacon 308 at an elevation of 1598.1 mASL) and approximately 10.9 km south-west of the settlement of Babanango (Ulundi Local Municipality), as the crow flies. Babanango is located on the uMhlathuze-Mfolozi watershed. From the uMhlathuze headwaters, the river meanders in a south-easterly direction, passing the town of Nkandla (Nkandla Local Municipality) in the west and the town of Melmoth (Mthonjaneni Local Municipality) in the east. At the Nkandla-Mthonjaneni-uMlalazi local municipal boundary, the uMhlathuze River flows eastward, passing the town of Eshowe to the south. At the Mthonjaneni-uMlalazi-uMhlathuze local municipal boundary, the uMhlathuze River meanders in a southerly direction, passing the town of Empangeni to its east before discharging into Richards Bay (formerly called the uMhlathuze Bay/Lagoon<sup>2</sup>), the “largest port in South Africa by tonnage, handling about 89 million tonnes of cargo per year (by means of over 1 800 commercial vessel calls), equating to about 40% of South Africa’s total port demand” (KZN Planning Commission 2018: 118).

The integrated uMhlathuze System consists of:

- The Goedertrouw Dam, which is the largest water resource in the system. The dam supplies water to the Greater Mthonjaneni WTP below the dam wall. Releases are also made to from the dam for abstraction at the uMhlathuze Weir for irrigation, industry and domestic water use. Furthermore, water from the weir is pumped north to the Nsezi WTP, as well as south towards users around Lake Cubhu.
- Local coastal lakes, namely, Lake Nsezi, Lake Cubhu, Lake Mzingazi and Lake Nhlabane. These lakes are augmented by abstractions from the Mfolozi River by Richards Bay Minerals, as well as the abstractions at the uMhlathuze Weir (as mentioned above).
- The Thukela-Goedertrouw Transfer Scheme (near Middledrift), which was built as a drought emergency scheme in 1997. This scheme was designed to pump 1.2 m<sup>3</sup>/s but only supplies up to 1.0 m<sup>3</sup>/s (as a result of operational inefficiencies) from the uThukela River over the divide

---

<sup>1</sup> 2016 municipal boundary (Municipal Demarcation Board).

<sup>2</sup> Jones 2014:1.

into the Goedertrouw Dam. An upgrade of the Thukela-Goedertrouw Transfer Scheme capacity, from 1 to 2 m<sup>3</sup>/s, was proposed and designed during the 2014/15 drought. This upgrade includes the installation of additional river abstraction pumps, the construction of a parallel de-sanding works, parallel high lift pump station and a parallel rising main from the second high lift pump station to the Mvuzane stream which feeds the Goedertrouw Dam. Following a long period of contractual-related challenges, construction works are underway and the project is expected to be completed in October 2023.

In addition to the uMhlathuze River, water supply to the Richards Bay area is reliant on the coastal freshwater lakes of Mzingazi, Nhlabane, Nsezi, Cubhu and Mangeza, as well as the coastal primary aquifers (Kelbe and Germishuyse 2001: 45).

Umgeni Water (UW) has recently (2020) signed a Bulk Supply Agreement (BSA) with KCDM to take over the role of providing water services within the KCDM area. As part of the BSA, UW will initially operate and maintain all schemes including small and rudimentary schemes with the view of eventually replacing them with more efficient bulk schemes during the life of the contract to reduce operating costs, while increasing the reliability and assurance of supply. The agreement does not include the City of uMhlathuze as it is a WSA on its own.

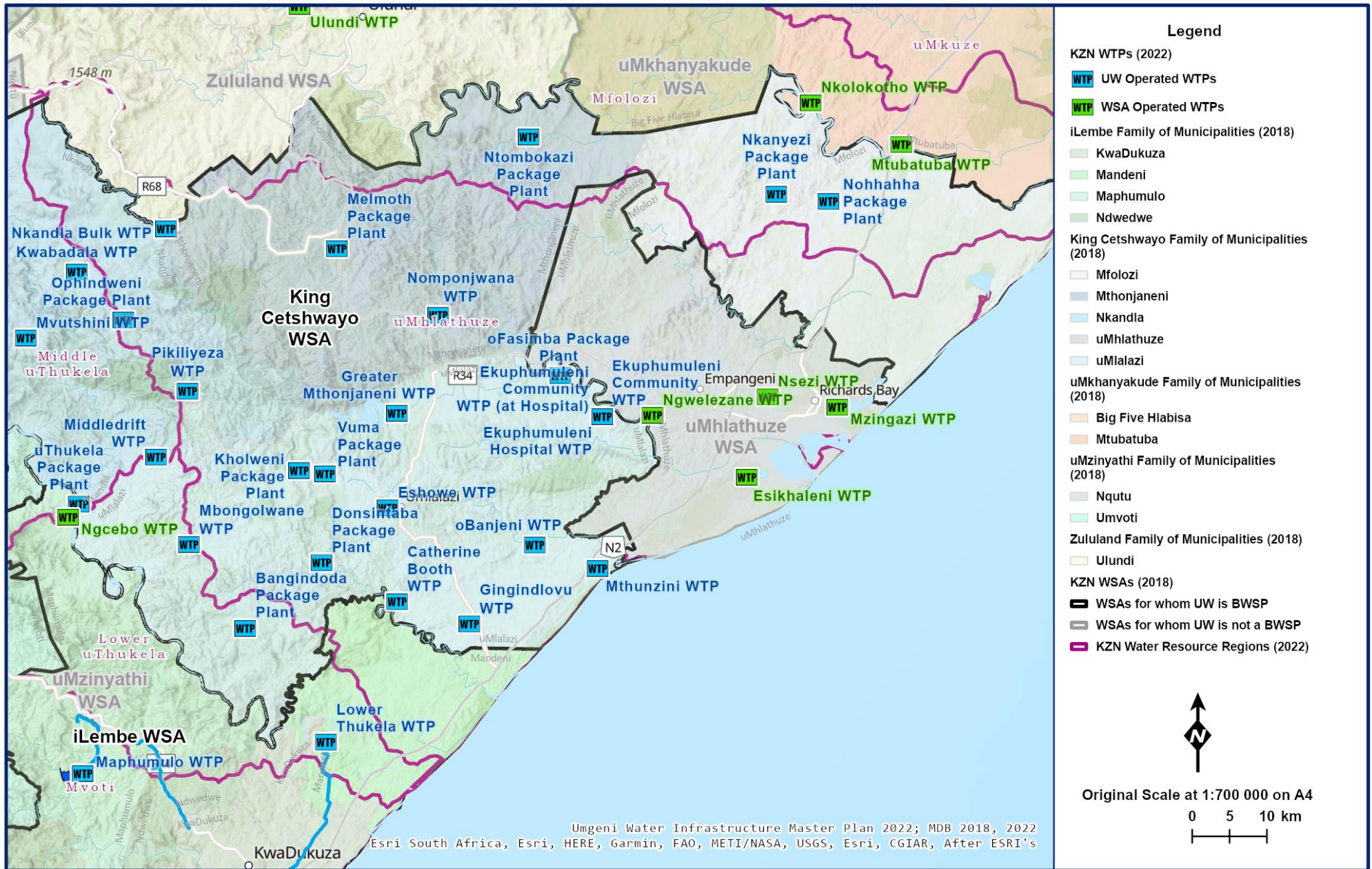

Figure 16.1 General layout of the uMhlathuze System.



## 16.2 Water Resources of the uMhlathuze System

### 16.2.1 Description of the uMhlathuze System Water Resource Regions

#### (a) uMhlathuze Region

##### (i) Overview

From its headwaters, the uMhlathuze River meanders in a south-easterly direction for approximately 4.2 km, at which point it becomes the Zululand-King Cetshwayo District Municipal boundary<sup>3</sup> (2830BD 1:50 000 Topographic Map 2013). The uMhlathuze River continues to meander in a south-easterly direction, with the Gologodo Stream joining the uMhlathuze River upstream of the Riversmeer and Phambana settlements<sup>4</sup> (2831AC 1:50 000 Topographic Map 2013). The Babanango Dam on the Gologodo Stream (approximately 2 km south-west of Babanango as the crow flies) supplies Babanango via a water treatment plant (WTP) located immediately downstream of the dam wall (**Figure 16.2**).

The uMhlathuze River continues meandering in a south-easterly direction with contributions from the Gosweni, Mbizweni, Manzimnyama and Ngwekweni Rivers flowing from the west across Ingoyama Trust Board (ITB) land (2831AC 1:50 000 Topographic Map 2013). Approximately 2 km downstream of the uMhlathuze-Ngwekweni confluence is where a weir from which water is abstracted for the Nkandla Bulk WTP (located approximately 150 m north-east of the P226 bridge over the uMhlathuze River) is located (2831AC 1:50 000 Topographic Map 2013). At the P226 bridge, the Zululand-King Cetshwayo District Municipal boundary stops following the uMhlathuze River, with the river flowing in a southerly direction and the Xhaphozini and Nomasila Rivers joining from the east.

The Ntumbeni River, located south of the Nkandla cemetery and wastewater works (WWW), flows east across ITB land, joining the Madiyana River (also on ITB land), located east of Nkandla, which discharges into the uMhlathuze River (2831AC 1:50 000 Topographic Map 2013). The uMhlathuze River meanders in a south-easterly direction with the Nyawashune River, Middle uThukela-uMhlathuze watershed, joining it from the west (2831CB 1:50 000 Topographic Map 2013). The uMvuzane River meanders from the west, passing the KwaNtoza Hill (Trig Beacon 256 at an elevation of 843.8 mASL), with the Bomvana River joining it from the south, downstream of the KwaNtoza Hill before it flows into the uMhlathuze River (2831CD 1:50 000 Topographic Map 2013). The Nhlisa River flows from the south into the uMhlathuze River downstream of the Bomvana-Mhlathuze confluence (2831CD 1:50 000 Topographic Map 2013). Thereafter, the uMhlathuze River flows into Goedertrouw Dam in the Nkwaleni Valley (2831CD 1:50 000 Topographic Map 2013).

Tributaries flowing into Goedertrouw Dam from the south include Vuma, Ndlovane and Ncemaneni (2831CD 1:50 000 Topographic Map 2013)). The Manzini River, whose headwaters are near the St. Mary's Hospital in the KwaMagwaza settlement (2831CB 1:50 000 Topographic Map 2013), meanders from the north into the KwaMazula River which flows into Goedertrouw Dam (2831CB 1:50 000 Topographic Map 2013).

<sup>3</sup> 2016 municipal boundary (Municipal Demarcation Board).

<sup>4</sup> Approximately 1.7 km south-east of Owen's Cutting (2831AC 1:50 000 Topographic Map 2013).

The uMhlathuze meanders eastwards from the Goedertrouw Dam Wall, with tributaries including the Mfule flowing into it from the north-west. Tributaries of the Mfule include the Mfulazane on which the Melmoth Off-Channel Storage Dam (2831CB 1:50 000 Topographic Map 2013) is located. At the Majaji-Mhlathuze confluence (the Ntambanana River, whose headwaters are located south of the the Ntambanana settlement is a tributary of the Majaji River) the uMhlathuze River flows in a south-easterly direction, passing the town of Empangeni on the east. The uMhlathuzana River discharges into the uMhlathuze River from the west and the Mpangeni River, flowing on the outskirts of Empangeni via the Mpangeni Lake, discharges into the uMhlathuze River from north (2831DD 1:50 000 Topographic Map 2013). The uMhlathuze River then flows eastwards, passing the Sigwenyane and Niwe Lakes to the east and the Mangeza Lake, adjacent to the University of Zululand, to the west. It continues to meander eastward with the Nseleni River flowing into it from the north, passing the weir from which water is abstracted for Empangeni before it discharges into the uMhlathuze Estuary.

The Richards Bay harbour was developed in the 1970s with the construction of a 4 km berm which divided the uMhlathuze Estuary into two compartments. The northern part of the estuary was developed as a deep water harbour while the southern part was retained as a natural estuary, commonly referred to as “the sanctuary” (Kelbe and Germishuyse 2001: 47; DWS 2015: 16). The uMhlathuze River was canalised and the natural flow of the river diverted into “the sanctuary” and “in 1975, a new mouth was dredged through the sandbar approximately 5 km to the south of the original mouth” (DWS 2015: 16).

Lake Mpangeni, Lake Sigwenyane, Lake Niwe and Lake Mangeza are identified as “off-channel lakes”. Kelbe and Germishuyse explain that:

“Several small catchment rivers flowing into the uMhlathuze River just upstream of the old N2 road bridge, do not have sufficient flow to maintain an open channel connection. The lower reaches of these rivers in the uMhlathuze flood plain have been blocked by sand bars and have formed small lakes. These lakes have formed in the incised valleys with shallow soils overlying granitic formations. Consequently, these off channel lakes function in a different manner to the coastal lakes situated in a highly permeably sedimentary aquifer.

These off-channel lakes along the uMhlathuze River are considered to be dominated by both surface runoff characteristics and groundwater seepage through the lake. The discharge is generally through groundwater into the uMhlathuze River.”

(Kelbe and Germishuyse 2001: 49)

The headwaters of the Nseleni River are located to the north, approximately 3 km from the uMhlathuze-Mfolozi watershed and approximately 1 km from the Ndongondwana settlement as the crow flies (2831DA 1 : 50 000 Topographic Map 2013). The Nseleni River meanders eastward and at the confluence with the Mvuzane River (2831DB 1:50 000 Topographic Map 2013), it flows southwards with the Okula River joining it from the west. The Nseleni-Okula confluence is located approximately 7 km west of the Nseleni settlement as the crow flies and approximately 320 m east of the Reding Dam Wall (2831DB 1:50 000 Topographic Map 2013). The Okula River is located to the north of Empangeni. The Nseleni River meanders to the south of the Ntseleni settlement, forming the eastern boundary of the Enseleni Nature Reserve before flowing into the Nsezi Lake (2831DB 1:50 000 Topographic Map 2013).

Lake Nsezi is “located on the western edge of the coastal plain” (Kelbe and Germishuyse 2001: 50). This coastal plain is:

“... the largest primary aquifer in southern Africa, extending from Mtunzini on the Zululand coast up through Maputaland for the full length of the Mozambique coastal zone. This region is very flat with highly permeable soils that promotes a rapid recharge to the aquifer. The uppermost formation on this coastal plan is an uncontrolled aquifer which has as its upper boundary a “water table” that is the top of the saturated zone.”

(Kelbe and Germishuyse 2001: 17)

Lake Nsezi is therefore considered to have a significant groundwater component (**Section 16.2.1 (a)(iii)**) but is controlled to a large extent by the Nseleni River that is situated in a very different geological region” (Kelbe and Germishuyse 2001: 50). Lake Nsezi is therefore called a “combination lake” (Kelbe and Germishuyse 2001: 50). Lake Nsezi further obtains water via a weir on the uMhlathuze River to “supplement water that is abstracted from the lake for industrial and domestic use” (Jones 2014: 31).

Rivers flowing into Lake Mzingazi, a coastal lake (Kelbe and Germishuyse 2001: 49), include Nundwane from the north and Mpisini and Bhodlisa from the north-east (2832CA 1 : 50 000 Topographic Map 2013). Kelber and Germishuyse explain coastal lakes as follows:

“... coastal lakes have significant flow-through characteristics where there is generally continuous and simultaneous recharge and discharge through various parts of the lake bed to the aquifer. Generally, this seepage rate is greatest at the surface shoreline and decreases exponentially with distance underneath the lake. It has been assumed that the Zululand coastal lakes also have direct interaction with the aquifer and that they have similar seepage characteristics. Consequently, these lakes are assumed to be supplied through direct rainfall interception, surface runoff from riparian zones, streamflow and groundwater recharge. The lakes in the Richards Bay area which are controlled by subsurface conditions include Lake Nhlabane, Lake Mzingazi and Lake Qhubu.”

(Kelbe and Germishuyse 2001: 49)

Lake Mzingazi has two main compartments with the “southern part of the lake separated from the northern part by a very shallow and narrow section that is exposed during extremely dry conditions” (Kelbe and Germishuyse 2001: 51). Kelbe and Germishuyse identified that the “southern compartment is approximately 14 m below mean sea level at its deepest point and is therefore susceptible to saline intrusion under adverse conditions” (2001: 51).

Rivers flowing into Qhubu Lake, a coastal lake, include Mzingwenya and Mpembeni (2831DD 1:50 000 Topographic Map 2013). Kelbe and Germishuyse (2001) elaborate as follows:

“Lake Qhubu is situated to the south of the Richards Bay Harbour and is assumed to have originally been part of the uMhlathuze Estuary but has become isolated by deposition processes on the northern sections of the lake. During flood events, the overflow from the lake is believed to flow through this section directly into the uMhlathuze estuary via a small channel linked to a series of canals on the uMhlathuze floodplain.”

(Kelbe and Germishuyse 2001: 64)

The headwaters of the Mlalazi River are located approximately 3 km north-east of the Entumeni Nature Reserve as the crow flies. It flows approximately 3.5 km in a south-easterly direction into the Ihlazi Dam and then into the Rutledge Park Dam with the D313 road separating the two dams (2831CD 1:50 000 Topographic Map 2013). The Ihlazi Dam and the Rutledge Park Dam are located north of the Dlinza Nature Reserve and Eshowe. The Mlalazi River meanders north of Eshowe and then eastward with tributaries including the Mtilombo, Ndlovini and Tondo flowing in from the north and the Mkukuze and Bhadi flowing in from the west (2831DC 1:50 000 Topographic Map

2013), before it flows east around Mtunzini and north of the Umlalazi Nature Reserve, into the Indian Ocean (2831DD 1 : 50 000 Topographic Map 2013).

The headwaters of the Matigulu River are located approximately 440 m west of the Osulgulweni settlement and approximately 850 m south-east of Trig Beacon 79 at an elevation 856.5 mASL on the uMhlathuze-Lower-uThukela watershed. It meanders in a southerly direction, flowing through wetlands at Mpongolwane (2831CC 1:50 000 Topographic Map 2013) and then heads eastward with the Matimefu River joining it from the north (2831CD 1:50 000 Topographic Map 2013). As the Matigulu River continues meandering eastward, the uMngwenya River joins it from the west and the Mkono, Nwaku and Mpushini (with its headwaters located south of the Dlinza Nature Reserve) Rivers joining it from the north (2831CD 1:50 000 Topographic Map 2013). At the Mpushini-Matigulu confluence, the Matigulu turns southward, with Honothi and the Mombeni flowing into it from the west and the Bumba River from the north (2831CD 1:50 000 Topographic Map 2013). The Matigulu River continues meandering southward, passing the Catherine Booth Hospital on the east (2831CD 1:50 000 Topographic Map 2013), the Msunduze River discharging into it from the west (2931AB 1:50 000 Topographic Map 2013) and the Nyezane River flowing into it from the north (2931BA 1:50 000 Topographic Map 2013). The settlement of Gingindlovu is located approximately 5.6 km north of the Nyezane-Matigulu confluence (2931CD 1:50 000 Topographic Map 2013). The Matigulu River flows in a south-easterly direction and at the confluence with the iNoyoni River, which flows parallel to the coast, turns eastward into the Matigulu Lagoon (2931BA 1:50 000 Topographic Map 2013).

## (ii) Surface Water

The predominant land cover categories in the uMhlathuze Water Resource Region are forested land, cultivation and residential areas (predominately rural). The hydrological characteristics for this region are summarised in **Table 16.1**.

**Table 16.1 Hydrological Characteristics of uMhlathuze Region (WR2012: Usutu-Mhlathuze Quat Info WMA 6 July2015).**

Region	River (Catchment)	Area (km <sup>2</sup> )	Annual Average			
			Evaporation (mm)	Rainfall (mm)	Natural Runoff (million m <sup>3</sup> )	Natural Runoff (mm)
uMhlathuze	Matigulu River (W11)	954	1300	1077	198.2	207.8
	uMhlathuze River (W12)	4209	1375	973	628.6	149.4
	Mlalazi River (W13)	498	1300	1205	131.0	264.7

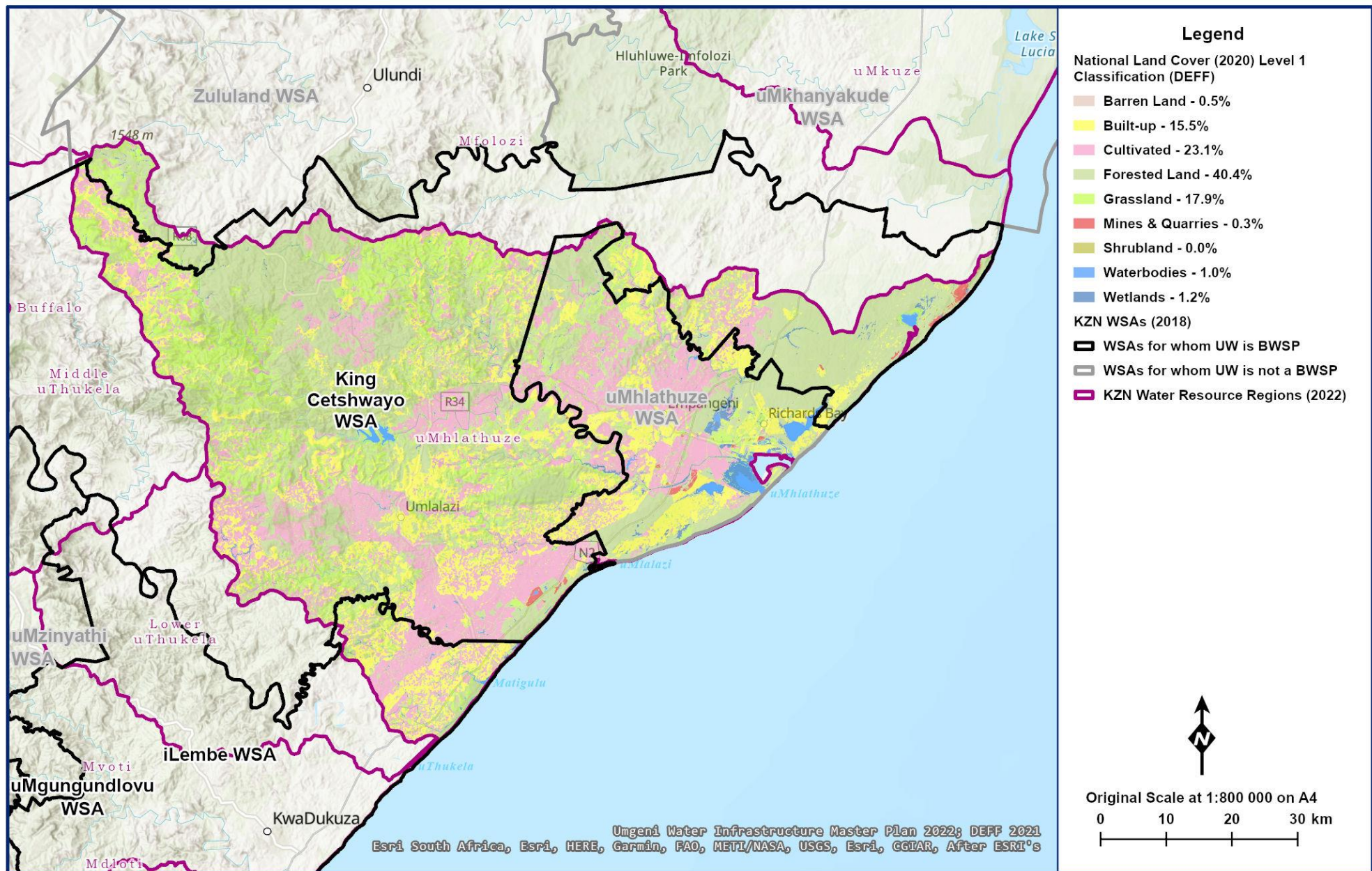

Figure 16.2 Land cover map of the uMhlathuze Region (DEFF 2020, MDB 2020, Umgeni Water 2022, WR2012).

### (iii) Groundwater

The uMhlathuze Region is located in three hydrogeological regions; the Northern Eastern Middleveld, KwaZulu-Natal Coastal Foreland and Southern Lebombo (DWAF 2008) (**Figure 16.3**).

- **Hydrogeological Units**

The oldest rocks in KwaZulu-Natal, forming part of the Kaapvaal craton, are of Swazian age and are represented, by the Nondweni Group and Empangeni Metamorphic Suite of the Barberton Sequence and its intrusive granites. These rocks are overlain by the rocks of the Pongola Supergroup. These metamorphosed sedimentary and volcanic rocks rest unconformably upon the granites.

The Natal Group outcrops in the Eshowe and Hlabisa areas, where it rests unconformably on the basement granites in parts. The Dwyka Formation rests unconformable on the Natal Group. Pietermaritzburg shale and the Vryheid Formation are the other significant sedimentary rocks in the area.

Outcrops of Karoo dolerite occur throughout the area and form massive sills that have intruded the Karoo Formation.

- **Geohydrology**

The Vryheid Formation has a very similar yield distribution to the Pietermaritzburg Shale contradicting the belief that porosity plays a role in groundwater occurrence and yield in these rocks. Dykes and sills are as important for the occurrence of groundwater in these sandstones as for that in the Pietermaritzburg Shales.

The Karoo dolerite sills can form extensive weathered and fractured aquifers with, on average, moderate borehole yields.

- **Groundwater Potential**

The groundwater resources are suitable for the development of primary rural water supply boreholes. The main constraints to exploitation are the low permeability's of the aquifers and the really limited nature of the weathered and fractured zones of the various rocks within the area. This results in relatively low to average sustainable borehole yields.

Eighty percent of the reported borehole yields fall into the poor to moderate category (< 3 ℓ/s). Poor yields are typically found in areas of severe topography in all lithologies, but particularly where unweathered dolerite capping occur.

### (iv) Water Quality

- **Surface Water**

There is no surface water quality information available for this region at this time.

- **Groundwater**

Groundwater quality is generally good with electrical conductivity (EC) <70 mS/m. Groundwater of unacceptable quality due to excessive EC is found in areas in the Dwyka Tillite and Pietermaritzburg Formation Shales. Groundwater of acceptable quality occurs in the basement granites and Natal Group Sandstones (**Figure 16.3**).

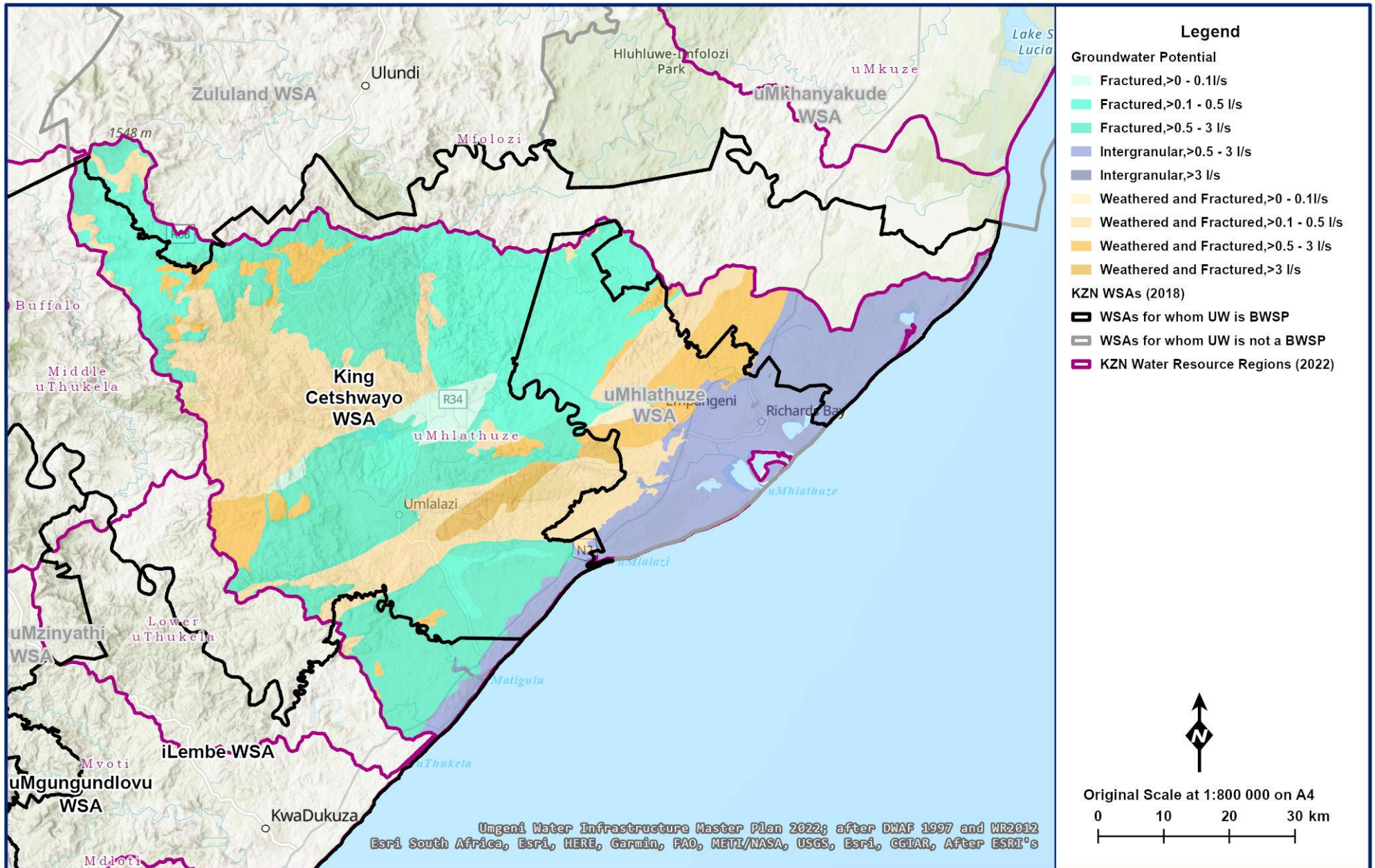

Figure 16.3 Groundwater potential in the uMhlathuze Region (MDB 2020, Umgeni Water 2022, after DWA 1997 and WR2012).

## 16.2.2 Reserve

### (a) uMhlathuze Region

In December 2021, DWS commissioned a study entitled *Classification of Significant Water Resources and Determination of Resource Quality Objectives for Water Resources in the Usutu to Mhlathuze Catchments* in order to reassess the present ecological status of water resources in the region. The study will also make recommendations for the targeted ecological status of the different parts of this Water Resource Region. The study is expected to be completed in July 2024 and the updated findings will be reported as soon as the final report is Gazetted by DWS. Whilst the DWS study is still incomplete, the latest available Reserve information for the Mhlathuze Water Resource Region is reported below.

#### (i) Nhlabane Estuary

The Ecological Water Requirements set for the estuary were based on the assumption that water required to make the fishway operational would be available. Establishing a partial link between the lake and estuary would result in an improvement of the functioning of the system and would be sufficient to raise the estuary to an Ecological Category C. Raising the Ecological Category to B would require continuous operation of the fishway, lowering of the barrage and rehabilitation of the riparian areas. Improvement to an ecological category A would require complete removal of all barriers and rehabilitation of the catchment (DWS 2015).

#### (ii) Lake Nhlabane

A number of mining-associated activities have had negative impacts on the system. These were related to the construction of a barrier between the estuary and the lake (the barrage), continued abstraction of water by Richards Bay Minerals (RBM) from the estuary itself and the effects of the RBM dredger and plant machinery crossing the estuary. The present and recommended ecological status for the lake is class C, with a high ecological importance (DWS 2015).

#### (iii) uMhlathuze Estuary

The present health category of the uMhlathuze Estuary is a C. The recommended ecological category proposed by previous studies was a C/D (DWS, 2015). This suggests that there may be merit in re-assessing the Recommended Ecological Category of the uMhlathuze Estuary in future.

#### (iv) uMhlathuze River

The construction of Goedertrouw Dam, together with extensive land use impacts on the catchment, have resulted in changes in the habitat integrity, ecological status and hydrology of the river. While the river has low to moderate social importance, it has moderate to very high ecological importance, which justifies the need for the application of an Ecological Reserve. The status of the river ecology is shown in **Table 16.2** below.



**Table 16.2 uMhlathuze River Ecological Status (DWS, 2009).**

River Reach	PES		Importance		AEMC	
	Instream	Riparian	Ecological	Social	Instream	Riparian
Goedertrouw Dam to Mfule Confluence	C/D	E	Moderate	Moderate	C/D	D
Mfule Confluence to uMhlathuze Weir	C/B	D	High	Moderate	B	C/D
uMhlathuze Weir to Estuary	E	E	Very High	Low	N/A	

*PES ~ Present Ecological Status*

*AEMC ~ Attainable Ecological Management Class*

## 16.2.3 Existing Water Resource Infrastructure and Yields

### (a) uMhlathuze Region

The Mhlathuze Water Resource Region is a complex system with a lot of water resources infrastructure, including small farm dams. For the purpose of this report, only the major water resource infrastructure will be discussed.

The largest water resource in the Mhlathuze Region is the Goedertrouw Dam (**Figure 16.4** and **Table 16.3**) on the uMhlathuze River, which supplies water (through releases into the Mhlathuze River) for downstream irrigation in the Mlalazi LM (KCDM WSA) and the City of uMhlathuze WSA. In addition, releases are made for industrial and domestic purposes as far as Richards Bay, with the main abstractions occurring at the uMhlathuze Weir. The dam also supplies water to the Greater Mthonjaneni WTP which is located below the dam wall. The Greater Mthonjaneni WTP has a capacity of 20 Mℓ/d, and supply from the WTP includes transfers to the Eshowe WTP to augment water supply from the Eshowe Water Supply Scheme. This transfer scheme began as a drought mitigation strategy during the 2014-2017 drought and has remained as an augmentation option as and when required. A project to upgrade the Greater Mthonjaneni WTP reservoir from 1 Mℓ to 10 Mℓ is currently underway (managed by KCDM) and is expected to be completed in 2024. The Dam is owned and operated by DWS and according to the DWS (2018) Hydrographic Surveys Dams Database, a new dam hydrographic survey is overdue as it was last undertaken in the year 1999. As a result, it is recommended that the dam hydrographic survey be undertaken.

Water Supply in the Mhlathuze System is augmented by the Thukela-Goedertrouw Transfer Scheme which was built as a drought emergency scheme in 1997. This scheme currently pumps water at approximately 1 m<sup>3</sup>/s from the uThukela River over the divide into the Mvuzane stream, which flows into the Goedertrouw Dam. This scheme is currently being upgraded to increase its capacity to 2 m<sup>3</sup>/s. The main impact of the scheme would be to increase the assurance of supply for the Mhlathuze system.

The Nkandla raw water abstraction weir, located at the headwaters of the Mhlathuze River (outlet of W12A), supplies water to the Nkandla Bulk WTP. Being a run-of-river abstraction system, there is limited storage potential on the infrastructure. Therefore, the yield is largely dependent on WTP capacity (3.6 Mℓ/d). Umgeni Water recently (2022) conducted a hydrographic survey on the weir and the installation of storage monitoring equipment is currently underway (to be completed in June 2023). The survey information, as well as storage observations will enable the development of

water resources yield assessment studies, as well as the configuration of water resources planning models to develop efficient operating rules.

Key water resources infrastructure found in the Mthonjaneni LM include the Melmoth abstraction weir, located in the Mfulazane River, which supplies raw water to the Melmoth Package Plant. As a run-of-river abstraction system, there is minimal storage in the weir and yield is limited by plant capacity (3.6 Ml/d). The Melmoth weir is supported by raw water from the Melmoth Off-Channel Storage Dam (**Figure 16.5** and **Table 16.4**). According to the DWS Dams Database, the Dam is owned by the Mthonjaneni Local Municipality. Umgeni Water recently (2022) conducted a hydrographic survey on the weir and the dam. The installation of storage monitoring equipment is currently underway (to be completed in June 2023). The survey information, as well as storage observations will enable the development of water resources yield assessment studies, as well as the configuration of water resources planning models to develop efficient operating rules.

Key water resources infrastructure found in the Mlalazi LM include the Eshlazi (**Figure 16.6** and **Table 16.5**) and Rutledge Park Dams (**Figure 16.7** and **Table 16.6**) which are located in the headwaters of the Mlalazi River (W13A). The dams are owned by the KCDM and supply raw water to the Eshowe WTP which supplies water to Eshowe town and surrounding areas. Yield determination studies for the two dams have been previously conducted by DWS (2015) and will be discussed below. Umgeni Water has recently (2022) conducted hydrographic surveys for the two dams and the results are shown in **Table 16.5** and **Table 16.6** below.

Other key water resources infrastructure in the region include:

- Abstraction from the uMhlathuze River upstream of the uMhlathuze Weir on the border with uMlalazi LM for the Ngwelezane WTP.
- Lake Nsezi, a “combination lake” (**Section 16.2.1 (a)**), as well as Lakes Nhlabane, Mzingazi and Qhubu, “coastal lakes” (**Section 16.2.1 (a)**). These lakes are augmented by abstractions from the Mfolozi River.
- Run-of-river abstraction for the Gingindlovu WTP from the Matigulu and Msunduze Rivers.



**Figure 16.4 Goedertrouw Dam (Aerial photograph taken by Helene Smith showing the extent of the drop in water levels).**

**Table 16.3 Goedertrouw Dam Hydrographic Survey (DWS 2018: Hydrographic Surveys Dams Database, DWS 2019: List of Registered Dams Database, WR2012).**

Catchment Details	
Incremental Catchment Area:	1280 km <sup>2</sup> <sup>a</sup>
Total Catchment Area:	1280 km <sup>2</sup> <sup>a</sup>
Mean Annual Precipitation:	876 mm <sup>b</sup>
Mean Annual Runoff:	336.38 million m <sup>3</sup> <sup>b</sup>
Annual Evaporation:	1450 mm <sup>b</sup>
Dam Characteristics	
Gauge Plate Zero:	145.1 mASL <sup>d</sup>
Full Supply Level:	214.0 mASL <sup>d</sup>
Spillway Height:	88 m <sup>c</sup>
Net Full Supply Capacity:	301.26 million m <sup>3</sup> <sup>d</sup>
Dead Storage:	14.15 million m <sup>3</sup> <sup>d</sup>
Total Capacity:	301.27 million m <sup>3</sup> <sup>d</sup>
Surface Area of Dam at Full Supply Level:	12 km <sup>2</sup> <sup>c</sup>
Original Measured Net Dam Capacity	315.38 million m <sup>3</sup> (1981) <sup>d</sup>
Second Measured Net Dam Capacity	315.38 million m <sup>3</sup> (1984) <sup>d</sup>
Third Measured Net Dam Capacity	304.04 million m <sup>3</sup> (1987) <sup>d</sup>
Fourth Measured Net Dam Capacity	301.26 million m <sup>3</sup> (1999) <sup>d</sup>
Dam Type:	Earth-fill <sup>c</sup>
Crest Length:	Crest Length: 660 m <sup>c</sup> Spillway Section: 660 m
Type of Spillway:	Uncontrolled Ogee <sup>c</sup>
Capacity of Spillway:	7000 m <sup>3</sup> /s <sup>e</sup>
Date of Completion:	1982 <sup>c</sup>
Date of Area Capacity Survey:	1999 <sup>d</sup>
Date of next Area Capacity Survey:	2017 <sup>f</sup> (Overdue)

<sup>a</sup> WR2012 quaternary catchment dataset (summation of the quaternary catchment areas contributing)

<sup>b</sup> WR2012 Database of Quaternary Catchment Information.

<sup>c</sup> DWS List of Registered Dams Database (April 2019).

<sup>d</sup> DWS Hydrographic Surveys Dams Database (2018).

<sup>e</sup> SANCOLD

<sup>f</sup> DWS Survey Return Period



**Figure 16.5 Melmoth Off-Channel Storage Dam (UW, 2022).**

**Table 16.4 Melmoth Off-Channel Storage Dam (DWS 2018: List of Registered Dams Database; UW 2022).**

<b>Catchment Details</b>	
<b>Incremental Catchment Area:</b>	1.75 km <sup>2</sup>
<b>Total Catchment Area:</b>	1.75 km <sup>2</sup>
<b>Mean Annual Precipitation:</b>	893
<b>Mean Annual Runoff:</b>	-
<b>Annual Evaporation:</b>	1762
<b>Raised Dam Characteristics</b>	
<b>Gauge Plate Zero:</b>	683.3 mASL
<b>Full Supply Level:</b>	692.6 mASL
<b>Spillway Height:</b>	18 m
<b>Net Full Supply Capacity:</b>	0.118 million m <sup>3</sup>
<b>Dead Storage:</b>	N/A
<b>Total Capacity:</b>	0.118 million m <sup>3</sup>
<b>Surface Area of Dam at Full Supply Level:</b>	0.026 km <sup>2</sup>
<b>Original Measured Dam Capacity</b>	0.138 million m <sup>3</sup>
<b>Dam Type:</b>	Earth Fill
<b>Crest Length:</b>	Crest Length: 182 m
<b>Type of Spillway:</b>	Open Channel
<b>Capacity of Spillway:</b>	N/A
<b>Date of Completion:</b>	1995
<b>Date of Area Capacity Survey:</b>	26/07/2022
<b>Date of next Area Capacity Survey:</b>	2027



**Figure 16.6 Eshlazi Dam (also known as Ihlazi Dam) on 15 March 2017 (Zululand Pix 2017: Facebook).**

**Table 16.5 Eshlazi Dam (DWS 2018: List of Registered Dams Database; DWS 2015: Eshowe Drought Operating Rules Study; UW 2022: Eshlazi Dam Hydrographic Survey).**

<b>Catchment Details</b>	
<b>Incremental Catchment Area:</b>	17.5 km <sup>2</sup> <sup>a</sup>
<b>Total Catchment Area:</b>	17.5 km <sup>2</sup> <sup>a</sup>
<b>Mean Annual Precipitation:</b>	1135 mm <sup>b</sup>
<b>Mean Annual Runoff:</b>	4.24 million m <sup>3</sup> <sup>c</sup>
<b>Annual Evaporation:</b>	1400 mm <sup>b</sup>
<b>Raised Dam Characteristics</b>	
<b>Gauge Plate Zero:</b>	482.7 mASL <sup>e</sup>
<b>Full Supply Level:</b>	490.2 mASL <sup>e</sup>
<b>Spillway Height:</b>	8 m <sup>a</sup>
<b>Net Full Supply Capacity:</b>	0.728 million m <sup>3</sup> <sup>e</sup>
<b>Dead Storage:</b>	N/A
<b>Total Capacity:</b>	0.728 million m <sup>3</sup> <sup>e</sup>
<b>Surface Area of Dam at Full Supply Level:</b>	0.228 km <sup>2</sup> <sup>e</sup>
<b>Original Measured Dam Capacity</b>	0.909 million m <sup>3</sup> <sup>a</sup> (1997)
<b>Dam Type:</b>	Gravity <sup>a</sup>
<b>Crest Length:</b>	Crest Length: 165 m <sup>a</sup> Spillway Section : 7 m <sup>d</sup> Non Spillway Section : 140 m <sup>d</sup>
<b>Type of Spillway:</b>	Ogee Spillway <sup>a</sup>
<b>Capacity of Spillway:</b>	N/A
<b>Date of Completion:</b>	1978 <sup>a</sup>
<b>Date of Area Capacity Survey:</b>	2022
<b>Date of next Area Capacity Survey:</b>	2027

<sup>a</sup> DWS List of Registered Dams (2018)

<sup>b</sup> WR2012 Mhlathuze Quaternary Info WMA 2015 spreadsheet.

<sup>c</sup> DWS (2016) Drought Operating Rules study.

<sup>d</sup> Measured on Google Earth.

<sup>e</sup> Umgeni Water Hydrographic Survey (2022).





**Figure 16.7 Rutledge Park Dam (Umgeni Water, 2022).**

**Table 16.6 Rutledge Park Dam (DWS 2018: List of Registered Dams Database; DWS 2015: Eshowe Drought Operating Rules Study; UW 2022: Rutledge Park Dam Hydrographic Survey).**

<b>Catchment Details</b>	
<b>Incremental Catchment Area:</b>	1.3 km <sup>2</sup> <sup>a</sup>
<b>Total Catchment Area:</b>	18 km <sup>2</sup> <sup>a</sup>
<b>Mean Annual Precipitation:</b>	1135 mm <sup>b</sup>
<b>Mean Annual Runoff:</b>	0.346 million m <sup>3</sup> <sup>b</sup>
<b>Annual Evaporation:</b>	1300 mm <sup>b</sup>
<b>Raised Dam Characteristics</b>	
<b>Gauge Plate Zero:</b>	477.0 mASL <sup>c</sup>
<b>Full Supply Level:</b>	482.0 mASL <sup>c</sup>
<b>Spillway Height:</b>	7 m <sup>d</sup>
<b>Net Full Supply Capacity:</b>	0.148 million m <sup>3</sup> <sup>c</sup>
<b>Dead Storage:</b>	N/A
<b>Total Capacity:</b>	0.148 million m <sup>3</sup> <sup>c</sup>
<b>Surface Area of Dam at Full Supply Level:</b>	0.087 km <sup>2</sup> <sup>c</sup>
<b>Original Measured Dam Capacity</b>	0.148 million m <sup>3</sup> <sup>c</sup>
<b>Dam Type:</b>	Gravity <sup>d</sup>
<b>Crest Length:</b>	Crest Length: 96 m <sup>d</sup>
<b>Type of Spillway:</b>	Ogee Spillway <sup>d</sup>
<b>Capacity of Spillway:</b>	N/A
<b>Date of Completion:</b>	1925 <sup>d</sup>
<b>Date of Area Capacity Survey:</b>	2022
<b>Date of next Area Capacity Survey:</b>	2027

<sup>a</sup> DWS (2016) Drought Operating Rules study.

<sup>b</sup> WR2012 Mhlathuze Quaternary Info WMA 2015 spreadsheet.

<sup>c</sup> Umgeni Water Hydrographic Survey (2022).

<sup>d</sup> DWS List of Registered Dams (2018).

In terms of water resources yield, the Goedertrouw Regional Scheme is the most viable source to supply water to Mthonjaneni, Kwahloko and Eshowe through the Greater Mthonjaneni WTP. The town of Eshowe and the Eshowe Water Supply Scheme (WSS) are supplied from both the Eshowe WTP positioned within the town and the Greater Mthonjaneni WTP via an offtake from the Kwahloko Reservoir (Umgeni Water 2019: 17). Water supply from the Greater Mthonjaneni WTP to the Eshowe WTP varies daily depending on (i) the demand from the Eshowe WSS and the productivity of the Eshowe WTP. This augmentation can be as high as 10 Mℓ/d. **Table 16.7** shows the yield of the Goedertrouw Dam, as well as major lakes within the Mhlathuze System.

**Table 16.7 uMhlathuze System yields (DWS 2015).**

Dam/Lake	Yield (million m <sup>3</sup> /annum)	Yield (Mℓ/day)
Goedertrouw Dam excl. uThukela Transfer	51.5	141.1
Goedertrouw Dam incl. uThukela Transfer	84.5	231.5
Lake Nsezi	6.6	18.1
Lake Cubhu	0.4	1.1
Lake Mzingazi	10.5	28.8
Lake Nhlabane with support from Mfolozi	34.5	94.5
Lake Nhlabane without support from Mfolozi	7.9	21.6
<b>Total Yield from lakes (support from Mfolozi)</b>	<b>52.0</b>	<b>142.5</b>
<b>Total Yield from lakes (no support from Mfolozi)</b>	<b>25.4</b>	<b>69.6</b>

Water uses in the Upper uMhlathuze River catchment impact on the yield of the Goedertrouw Dam, which is the main source of water for the Eshowe Water Supply Scheme and the City of uMhlathuze WSA. Municipal water use is the major water user, with uMhlathuze Water having registered water use of 108.1 million m<sup>3</sup>/a from the uMhlathuze River catchment downstream of the Goedertrouw Dam (DWA 2011: 14). The Goedertrouw Dam supplies water as far downstream as Richards Bay, including the Richards Bay industries and other surrounding areas.

The Mlalazi River Catchment is the main source of supply for the Eshowe Water Supply Scheme. However, commercial forestry is the largest user in the Mlalazi River catchment, impacting on the water availability for the Eshlazi and Rutledge Park Dams. These dams are operated in conjunction to supply raw water to the Eshowe WTP, with abstractions being made from the downstream dam (Rutledge Park) and releases being made from the upstream dam (Eshlazi) when the water level at Rutledge Park is low. In addition, this system is supplemented by supply from Goedertrouw Dam (uMhlathuze River) as and when needed. Two small treatment plants, namely Catherine Booth Hospital and Obanjeni WTPs, supply the surrounding communities.

The Matigulu River is a source of raw water for the Gingindlovu WTP, which supplies water to the Gingindlovu town and surrounding villages, as well as the area of Emacambini (Ilembe DM). This river also supports irrigation within the Eshowe Water Supply Scheme area. Similar to the Mlalazi River catchment, the abundance of commercial forestry within the Matigulu River catchment impacts on the runoff generation and system yield (DWA 2011: 14 – 19).

The Kwahloko Water Supply Scheme Area is supplied by the Mpungose Command reservoir which gets its potable water from the Greater Mthonjaneni WTP (Umgeni Water 2019: 18).

DWS has recently completed a study (April 2020) to review and update of the hydrology and yields of the uMhlathuze System as part of the improvement of the 2015 Reconciliation Strategy for Richards Bay and surrounding towns. In the study, DWS (2020) mention that a holistic approach is followed when assessing the yield of the Mhlathuze System. This approach considers the impact of tributaries downstream the Goedertrouw Dam on the system yield prior the major abstraction point (Mhlathuze Weir), rather than assessing the Goedertrouw Dam in isolation. From this assessment, a historic firm yield of 245 million m<sup>3</sup>/a was obtained for the Mhlathuze System and this includes transfers from the uThukela River. The long-term stochastic yield at various assurance of supply levels is shown in **Table 16.8** below.

**Table 16.8 The long-term stochastic yields of uMhlathuze System (DWS 2020).**

Stochastic firm yield at levels of assurance in supply (Mm <sup>3</sup> /annum)			
1:200	1:100	1:50	1:20
243.3	251.6	260.0	272.3

To enable annual and seasonal water resources planning, the short-term stochastic yield (for a period of five years) of the uMhlathuze System was also assessed in the DWS (2020) study (**Table 16.9**). Short-term stochastic modelling is important for short-term operation of the system based on various storage levels.

**Table 16.9 The short-term stochastic yield of uMhlathuze System at different starting storage levels (DWS 2020).**

Starting storage (% of live FSC)	Yield Mm <sup>3</sup> /annum at indicated Recurrence Interval in years					
	1:200	1:100	1:50	1:20	1:10	1:4
100%	207.33	214.00	227.44	250.46	269.27	297.76
80%	192.48	202.43	217.12	239.02	261.36	295.86
60%	174.18	184.10	198.77	224.01	247.87	289.51
40%	145.33	158.56	170.54	193.71	226.94	270.59
20%	101.50	114.83	126.15	153.84	179.65	212.59
10%	78.39	87.67	95.95	107.61	132.34	164.74

In August 2021, DWS commissioned a study to extend and maintain the Reconciliation Strategy of the Mhlathuze System, in order for the system yield estimates to remain relevant. Therefore, the study may include an update of the Hydrological and Water Resources Yield Model configuration based on available information. Findings from this study will be included in the future reports once available. The study is expected to be completed in July 2024.

The impact of the 2014-2017 drought prompted DWS to conduct a Drought Operating Rules (DOR) study for the Eshowe WSS (DWS, 2016). According to this study, the Eshlazi and Rutledge Park Dams operate as a unit to supply the Eshowe Water Supply Scheme and their combined historic firm yield is 1.29 million m<sup>3</sup>/a (3.53 Mℓ/d). The long-term stochastic yield of this integrated system was assessed by DWS using three different scenarios (for optimal utilisation of the resource between the two dams):

- Scenario 1 - both dams are drawn down simultaneously;

- Scenario 2 – the Rutledge Park Dam is emptied before the Eshlazi Dam is utilised; and
- Scenario 3 - the storage in both dams is split 50/50 to ensure that water was utilisation altered between Rutledge Park and Eshlazi Dams.

The results of the long-term stochastic yield analyses of the system, for different assurance levels of supply, are provided in **Table 16.10**. Different orders in utilisation of the storage from the two dams had very little effect of safe yield of the system. This is most likely as a result of the dams being close together and there being an insignificant catchment area for runoff generation into the lower Rutledge Park Dam. With UW now managing and operating the two dams, it has been established that operators utilise the Rutledge Park Dam until it reaches a relatively low level, before water is released from the Eshlazi Dam (i.e. Scenario 2).

**Table 16.10 The long-term stochastic yield of the integrated system of Eshlazi and Rutledge Park Dams for three different scenarios (DWS 2016).**

Scenario	Description	Yield at corresponding assurance level (Mm <sup>3</sup> /a)		
		1:20	1:50	1:100
1	Dual drawdown	2.1	1.77	1.57
2	Rutledge fully then Eshlazi	2.1	1.77	1.58
3	50/50 Stepwise drawdown with Rutledge first	2.1	1.77	1.57

The DWS (2016) study also developed short-term stochastic yield curves for the integrated system, to be used for short-term operation of the system, based on combined system storage levels (**Table 16.11**).

**Table 16.11 The short-term stochastic yield of the integrated system of Eshlazi and Rutledge Park Dams at different starting storage levels (DWS 2016).**

Starting storage (% of live FSC)	Yield Mm <sup>3</sup> /annum at indicated Recurrence Interval in years				
	1:200	1:100	1:50	1:20	1:10
100%	1.53	1.66	1.81	2.08	2.33
80%	1.50	1.60	1.78	2.02	2.30
60%	1.35	1.48	1.64	1.87	2.11
40%	1.15	1.25	1.40	1.50	1.78
5%	0.80	0.84	0.90	1.10	1.28

The DWS 2016 DOR study was conducted with limited information (i.e. no hydrographic survey for both dams). To improve the reliability of yield information, Umgeni Water has conducted hydrographic surveys (2022) for the two dams and is currently in the process of installing dam storage monitoring equipment. In addition, UW is conducting a water resources yield assessment study for the Eshowe WSS using the updated hydrographic survey information. The study will be completed in June 2023 and results will be included in the 2024/25 Infrastructure Master Plan.

## 16.2.4 Operating Rules

### (a) Mhlathuze Region

The Department of Water and Sanitation prepared an Annual Operating Analysis (AOA) for the uMhlathuze Water Supply System and the Goedertrouw Dam in May 2022. The purpose of AOA is to define and optimise the short-term (annual) allocation of water by means of operating rules. The outcome of the AOA is to minimise the risk of non-supply for high priority use in the system.

The annual operating rules for the 2022/23 operating year were as follows:

- Due to the high storage levels at the Goedertrouw Dam on 1<sup>st</sup> May 2022, no restrictions were proposed for the 2022/23 operating year if irrigators are limited to 94.7 million m<sup>3</sup>/a (of which 80 million m<sup>3</sup>/a is the limit for schemes dependent on the Goedertrouw Dam).
- The worst-case scenario showed that, if the storage follows 1:200 year drought trajectory (0.5% risk of failure), system failure would only occur later in 2024 and severe curtailments would only be required in 2025.
- It was recommended that no pumping occurs from the Thukela-Goedertrow Transfer Scheme.

Continued monitoring of storage levels, dams and lakes, as well as actual water use for all sectors are required to manage the system. The next AOA will be conducted in May 2023.

The water supply operating rule aims to utilise resources in the most cost efficient manner while maximising the yield of the system. In the Eshowe WSS, for example, DWS (2016) concluded that it is more cost-effective to optimise supply from the local Rutledge Park and Eshlazi Dams before water is transferred from the Goedertrouw Dam. A drought-operating rule was developed to determine the maximum allowable volume of water that should be abstracted each year from the Rutledge Park and Eshlazi Dam. The Eshowe WSS was chosen as a priority system for the development of operating rules as a result of the low storage volumes at both the Rutledge and Eshlazi Dams (DWS, 2016). The operating rules for these dams include the following (DWS, 2016):

- If the dams were spilling, a maximum of 8 Mℓ/day could be withdrawn from the local resource; and
- Once the dam stops spilling, the abstraction should be reduced to a maximum of 5.8 Mℓ/day.

The drought operating rule curtailment curves for the Eshowe WSS are shown in **Figure 16.8**. The rule is based on three decision date curves (August, May and February).

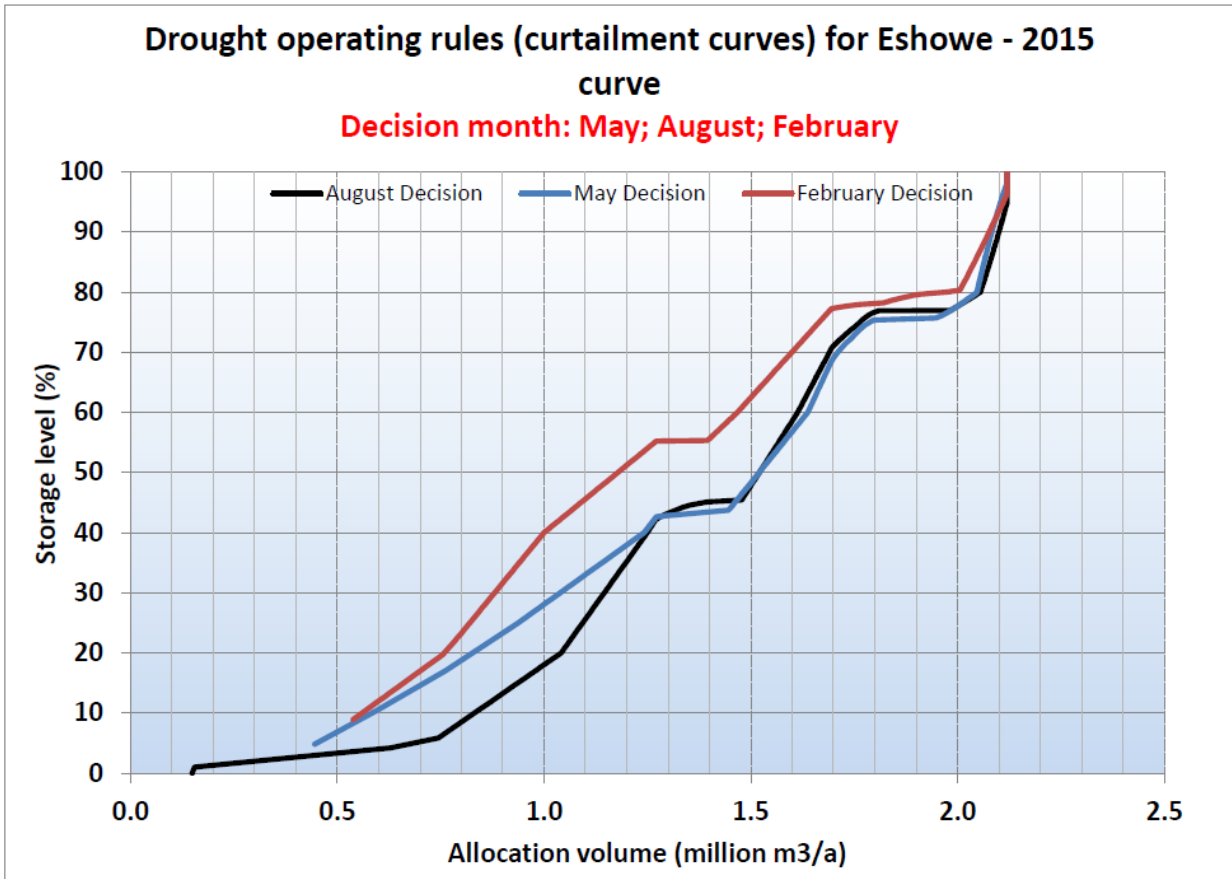
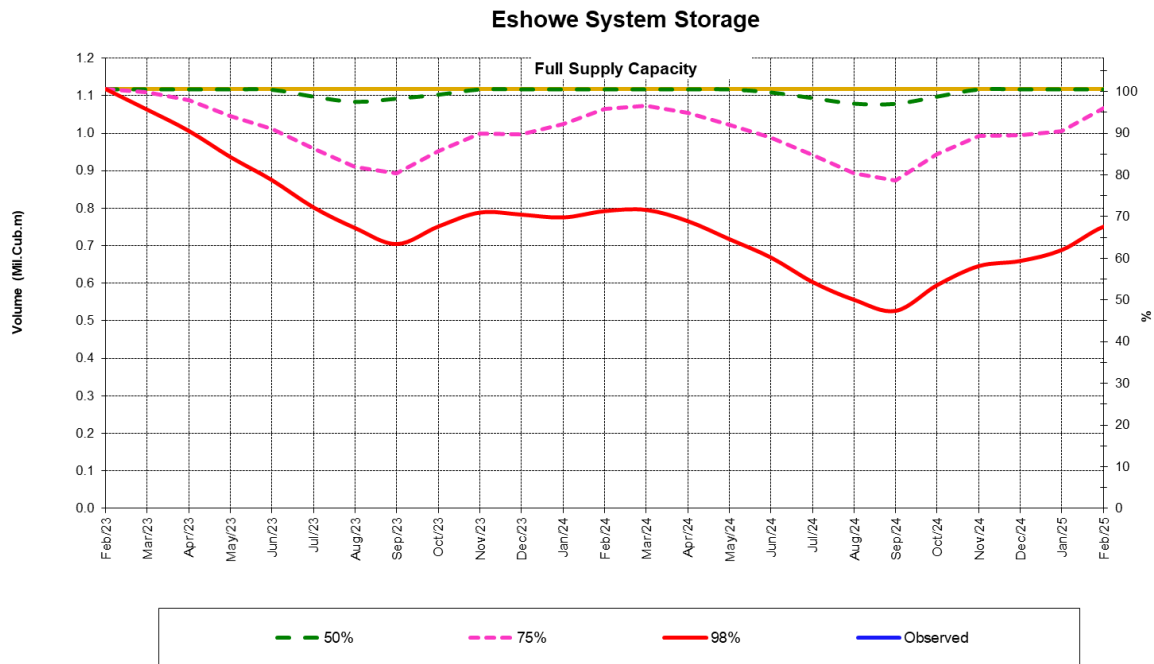

**Figure 16.8 The drought operating rules (Curtailment curves) for the Eshowe WSS (DWS 2015).**

The following conclusions can be drawn from the curtailment curve (**Figure 16.8**):

- The maximum amount of water that should be allocated from the two local dams is 2.1 million m<sup>3</sup>/a (5.8 Mℓ/day), when the storage volume is 100%;
- Once the combined storage volume drops below 80%, allocation should be reduced to less than 2 million m<sup>3</sup>/a (5.5 Mℓ/day); and
- If the combined storage level drops to approximately 50%, the maximum allocation should be reduced to 1.5 million m<sup>3</sup>/a (4.1 Mℓ/day) for a May decision date and 1.2 million m<sup>3</sup>/a (3.3 Mℓ/day) for a February decision date.

Umgeni Water updated the Eshowe WSS planning model for a February 2023 decision date with a starting storage of 100% FSC and an average abstraction of 3.5 Mℓ/day (July 2022 – Jan 2023). Based on this simulation, there is no risk of non-supply for the Eshowe WSS (**Figure 16.9**). It should be noted, however, that the average abstraction of 3.5 Mℓ/day is lower than the WTP capacity. Therefore, maximum abstraction may increase the possibility of non-supply. The next analysis will be conducted in May 2023.



**Figure 16.9 Storage trajectories for the Eshowe WSS based on a February 2023 Decision Date.**

The operating rules of uMhlathuze System, including Goedertrouw Dam, are as follows (DWS, 2020):

- Supply as much as possible of the 9 million m<sup>3</sup>/a required for the smelter from Lake Nhlabane as a first resort;
- If Lake Nhlabane cannot supply the full 9 million m<sup>3</sup>/a demand, supply the difference from uMhlathuze Water via Lake Nsezi;
- Supply the required 23 million m<sup>3</sup>/a for the RBM ponds from Mfolozi;
- If Mfolozi supply is insufficient, then supply from Lake Nhlabane (up to a total of 12 million m<sup>3</sup>/a, including what is supplied for the smelter); and
- Lastly, if the RBM ponds demand is still not met, then supply from Mhlathuze Water via Lake Nsezi (up to a total limit of 16 million m<sup>3</sup>/a, including what is supplied for the smelter).
- The transfer from the uThukela is to take place when Goedertrouw Dam drops below 75%.

## 16.3 Supply Systems

### 16.3.1 Description of the uMhlathuze System

#### (a) Overview

The uMhlathuze System is the main source of water for KCDM and the City of uMhlathuze. It supplies water to the rural settlements, urban areas and industries in the Nkandla, Mthonjaneni, uMlalazi and uMhlathuze Local Municipalities of KCDM. The uMhlathuze Local Municipality is a legislated water service authority referred to as City of uMhlathuze (CoU). **Figure 16.10** provides an



overview of the municipalities within KCDM and the relative location of CoU. It also shows the bounding District Municipalities of Zululand and Umkhanyakude to the north, Umzimyathi to the east and iLembe sharing its southern border.

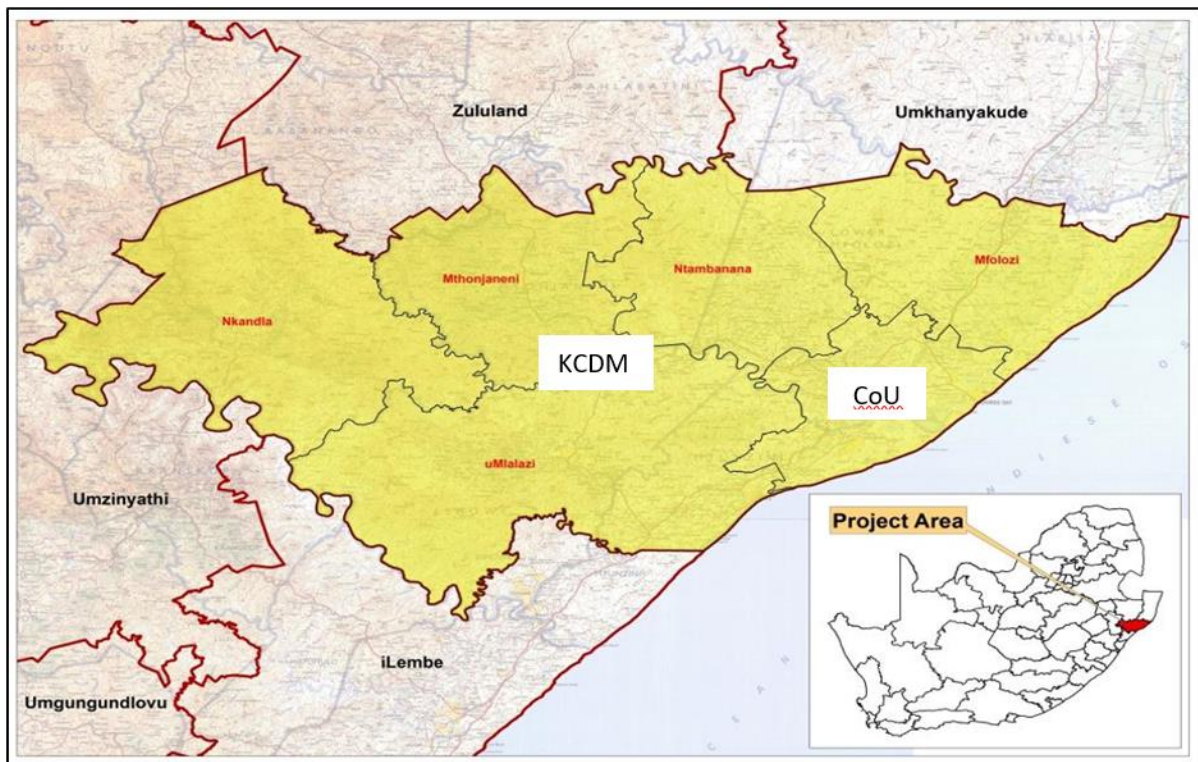

**Figure 16.10 KCDM and City of uMhlatuze**

The following WTPs obtain water from the uMhlatuze River. In some of these plants, the river augments supply and, in the case Greater Mthonjaneni WTP, supply is supplemented by an inter-basin transfer from the uThukela River. WTPs that have a treatment capacity greater than 2 Mℓ/day include the:

- Nkandla WTP;
- Middledrift WTP;
- Goedertrouw WTP;
- Eshowe WTP;
- eSikhaleni WTP;
- Nsezi WTP;
- Mzingazi WTP.

## (b) Nkandla Water Treatment Plant and Supply System

The Nkandla WTP (**Figure 16.12**) abstracts raw water from a weir on the uMhlathuze River (**Figure 16.11**). The plant has a capacity of 3.6 Mℓ/day and potable water is pumped to the Mpongose Tribal Authority, towards Nkandla Town. The Nkandla WTP currently produces 3.36 Mℓ/day (June 2022) which is within the design treatment capacity. The average moving average of the daily demands is 3.32 Mℓ/day. Associated bulk infrastructure consists of two pump stations, pumping a total head of 280 m, four bulk storage reservoirs, with a total capacity of 3 600 kℓ and 67 km of bulk pipelines, ranging from 90 mm to 160 mm in diameter.



**Figure 16.11: Nkandla abstraction weir at Mhlathuze River on 21 October 2021 (Photo by Umgeni Water).**



**Figure 16.12: The Nkandla WTP (Photo taken by UW).**

The Nkandla Water Treatment Plant Supply System is shown in **Figure 16.13** and the characteristics of the plant are indicated in **Table 16.12**.

**Table 16.12 Characteristics of the Nkandla WTP**

<b>WTP Name:</b>	Nkandla WTP
<b>System:</b>	Nkandla Bulk Supply System
<b>Maximum Design Capacity:</b>	3.9 Mℓ/day <sup>1</sup>
<b>Current Utilisation (January 2022):</b>	4.29 Mℓ/day
<b>Raw Water Storage Capacity:</b>	0
<b>Raw Water Supply Capacity:</b>	10 Mℓ/day
<b>Pre-Oxidation Type:</b>	Chlorine
<b>Primary Water Pre-Treatment Chemical:</b>	Polymeric Coagulant (SUDFLOC 3856)
<b>Total Coagulant Dosing Capacity:</b>	6 ℓ/hr
<b>Rapid Mixing Method:</b>	Hydraulic mixing
<b>Clarifier Type:</b>	Sedimentation Tanks (Dortmund type clarifiers)
<b>Number of Clarifiers:</b>	2
<b>Total Area of all Clarifiers:</b>	137.28 m <sup>2</sup>
<b>Total Capacity of Clarifiers:</b>	205.92 m <sup>3</sup>
<b>Filter Type:</b>	Slow Sand Filters
<b>Number of Filters:</b>	3
<b>Filter Floor Type</b>	Porous concrete floor type
<b>Total Filtration Area of all Filters</b>	1 875 m <sup>2</sup>
<b>Total Filtration Design Capacity of all Filters:</b>	162.5 m <sup>3</sup> /hr
<b>Total Capacity of Backwash Water Tanks:</b>	1Mℓ – Backwash water obtained from clear water reservoir
<b>Total Capacity of Sludge Treatment Plant:</b>	N/A
<b>Capacity of Used Washwater System:</b>	N/A
<b>Primary Post Disinfection Type:</b>	Chlorine gas
<b>Disinfection Dosing Capacity:</b>	0.4 kg/hr
<b>Disinfectant Storage Capacity:</b>	700 kg
<b>Total Treated Water Storage Capacity:</b>	1 Mℓ Clear water reservoir

<sup>1</sup>Nkandla Bulk Waterworks, Design Capacity Assessment, 2020

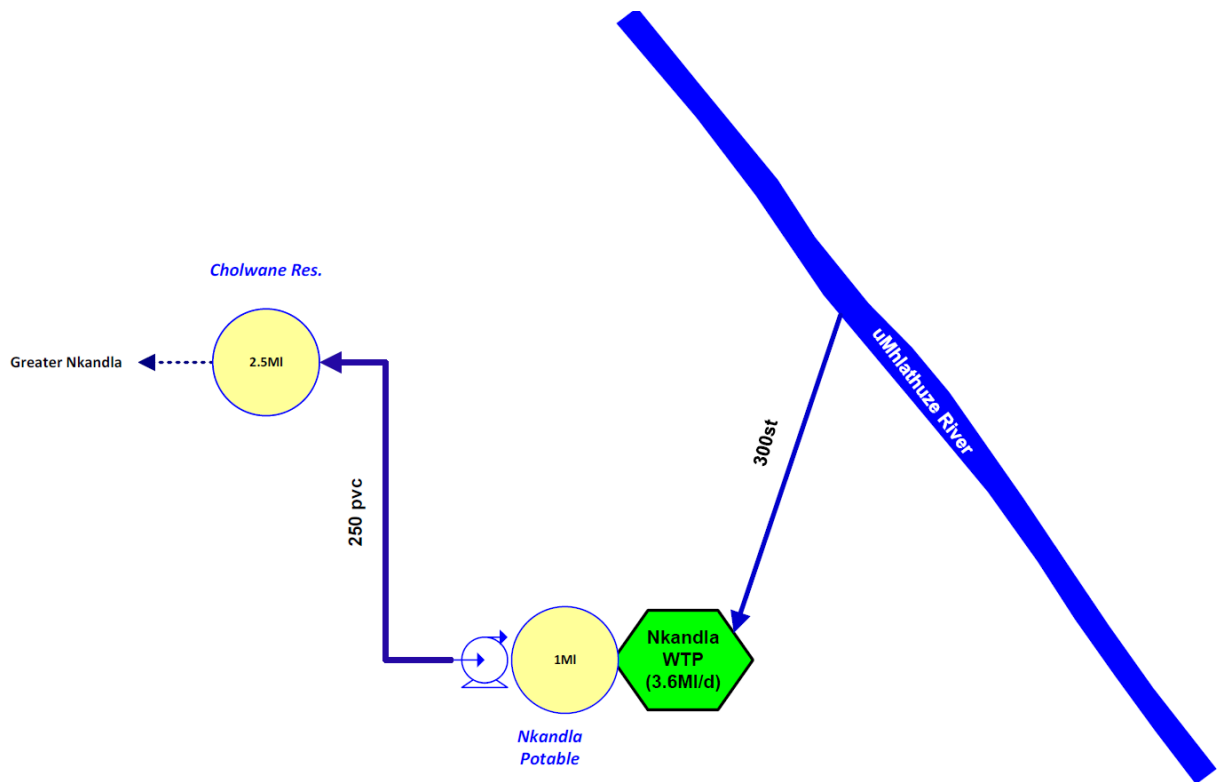

**Figure 16.13 Schematic of Nkandla WTP Supply System**

The Nkandla WTP is a conventional treatment plant comprising of the following process components:

- (i) Raw water is gravity fed from a weir located on the uMhlathuze River into a Pre-sedimentation tank from which two submersible pumps (duty/standby) convey water to an aerator.
- (ii) Flocculation channels: The raw water flows by gravity to the dosing room for pre-chlorination and coagulation. Lime is dosed after the hydraulic jump that is used for flash mixing. The coagulated water flows through the flocculation channel.
- (iii) Clarification (sedimentation) tanks: The flocs that have formed in the flocculation channels are settled in the two existing sedimentation tanks under gravity. The settled sludge is removed by frequent de-sludging of the tanks.
- (iv) Slow Sand Filtration: The clarified water is then filtered through a set of three slow sand filters as a final polishing before chlorination of the treated water.
- (v) Chlorine contact tank: The filtered water is disinfected and gravitate to the onsite clear water reservoir (1Mℓ) before pumping the water to the command reservoirs in the Nkandla supply area.

The reservoir, pump station and pipeline details are summarised in **Table 16.13**, **Table 16.14** and **Table 16.15**.

**Table 16.13 Pump Details: Nkandla WTP Supply System**

System	Pump Station Name	Number of Pumps		Pump Description	Supply From	Supply To	Static Head (m)	Duty Head (m)	Duty Capacity (Mℓ/day)
		Number of Duty Pumps	Number of Standby Pumps						
uMhlathuze	Nkandla Pump Station	2	1	KSB WKLn 100/7	WTP	Cholwane	139	147	3.12

**Table 16.14 Pipeline Details: Nkandla WTP Supply System**

System	Pipeline Name	From	To	Length (km)	Nominal Diameter (mm)	Material	Capacity (Mℓ/day)	Age (years)
uMhlathuze	Raw Water	Abstraction	WTP	0.6	300	Steel	9.2 <sup>1</sup>	22
uMhlathuze	Nkandla Bulk	WTP	Cholwane	6.4	250	uPVC	6.4 <sup>1</sup>	22

<sup>1</sup>Based on a velocity of 1.5m/s

**Table 16.15 Reservoir Details: Nkandla WTP Supply System**

System	Reservoir Site	Reservoir Name	Capacity (Mℓ)	Function	TWL (mASL)	FL (mASL)
uMhlathuze	Nkandla WTP	Nkandla Potable	1	Clear Well	873	868
uMhlathuze	Cholwane	Cholwane Reservoir	2.5	Balancing	1146	1141

### (c) Middelrift Water Treatment Plant and Supply System

The Thukela-Goedertrouw Water Transfer Scheme abstracts raw water from the left bank of the uThukela River (**Figure 16.14**). This scheme is being operated and maintained by Mhlathuze Water on behalf of Department of Water and Sanitation. The Madungela High Lift Pump Station (**Figure 16.17**) and the Mkhazazi High Lift Pump Station (**Figure 16.18**) transfer water across the catchment into the uMhlathuze catchment. Raw water for the Middelrift WTP is sourced from the Madungela High Lift Pump Station and is conveyed into two onsite raw water-holding tanks.

The Middelrift WTP, which is being operated and maintained by Umgeni Water, is at the Middelrift Village and supplies the village itself and surrounding villages up to Msobotsheni in the north east and Ntingwe in the south. The Middelrift WTP is shown in **Figure 16.15** and **Figure 16.16** and the supply system is shown in **Figure 16.19**.



**Figure 16.14 Thukela Transfer Scheme Abstraction Works.**



Figure 16.15 An aerial photo of the Middledrift WTP.



Figure 16.16 Photo of Middledrift WTP Clarifiers.





Figure 16.17 The Madungela High Lift Pump Station.



Figure 16.18 The Mkhhalazi High Lift Pump Station.

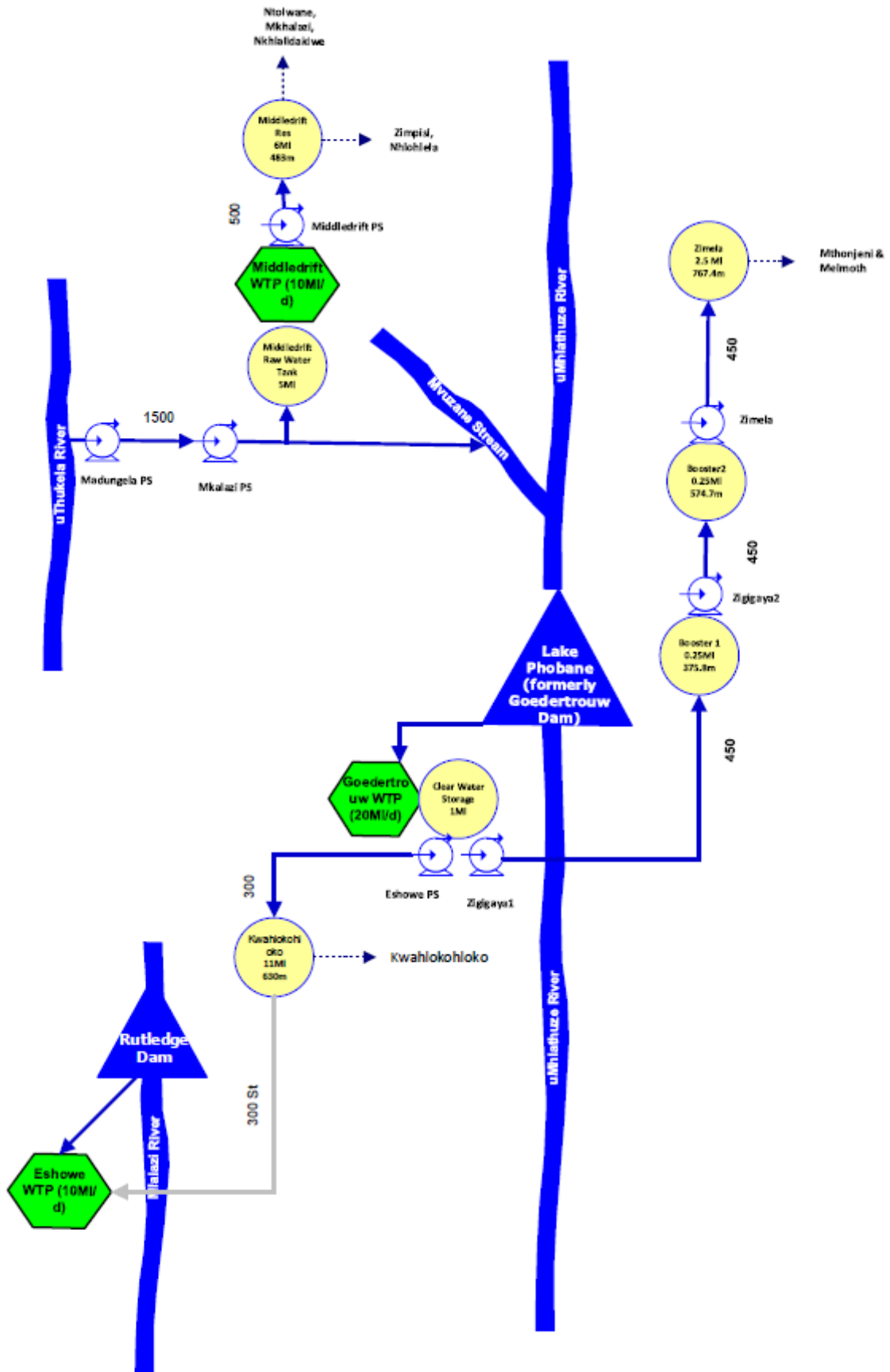

Figure 16.19 A schematic of Central uMhlathuze System.

The Middledrift WTP (**Table 16.16**) is a conventional treatment plant comprising the following process components:

- (i) Raw water holding tanks: Raw water for the Middledrift WTP is sourced from the Madungela pump station and is conveyed into two onsite raw water-holding tanks
- (ii) Static inline mixers: The raw water is conveyed by gravity to the inlet head of works (HoW) chamber where polymeric (SUDFLOC 3870) and Soda ash for pH correction is injected before two static inline mixers to achieve flash mixing. Chlorine is added for pre-chlorination process after the inline mixers.
- (iii) Clarification (sedimentation) tanks: The flocs that have formed are settled in the two clariflocculators under gravity. The settled sludge is removed by frequent de-sludging of the tanks.
- (iv) Rapid Gravity Sand Filtration: The clarified water is then filtered through a set of five rapid gravity sand filters as a final polishing before chlorination of the treated water. The filters are backwashed daily using the final water from the 1.25 Mℓ onsite reservoir. The spent backwash water is sent to the sludge holding tanks. The supernatant from the holding tanks is recycled to the head of works and the settled sludge is discharged to the drying beds.
- (v) Final water reservoir: The filtered water flows into the clearwells then into a collection chamber where chlorine is added before entering the final water reservoir, before pumping the water to the command reservoir in the Middledrift supply area.

The reservoirs pump station and pipeline details related to the Middledrift Supply Scheme are summarised in **Table 16.17**, **Table 16.18** and **Table 16.19**.

**Table 16.16 Characteristics of the Middledrift WTP**

<b>WTP Name:</b>	Middledrift WTP
<b>System:</b>	Middledrift Bulk Supply System
<b>Maximum Design Capacity:</b>	10 Mℓ/day
<b>Current Utilisation (January 2020):</b>	9.66 Mℓ/day
<b>Raw Water Storage Capacity:</b>	5 Mℓ
<b>Raw Water Supply Capacity:</b>	10 Mℓ
<b>Pre-Oxidation Type:</b>	None
<b>Primary Water Pre-Treatment Chemical:</b>	SUDFLOC 3870 and Soda Ash
<b>Total Coagulant Dosing Capacity:</b>	20.5 ℓ/hr
<b>Rapid Mixing Method:</b>	Static inline mixers
<b>Clarifier Type:</b>	Clarifloculators with paddle mixers and scrapers
<b>Number of Clarifiers:</b>	2
<b>Total Area of all Clarifiers:</b>	1 005.42 m <sup>2</sup>
<b>Total Capacity of Clarifiers:</b>	926 m <sup>3</sup>
<b>Filter Type:</b>	Rapid Gravity Sand Filters
<b>Number of Filters:</b>	5
<b>Filter Floor Type</b>	Suspended floor slab (CADAR GRC Monolithic flat panel) with underfloor drainage.
<b>Total Filtration Area of all Filters</b>	87.5 m <sup>2</sup>
<b>Total Filtration Design Capacity of all Filters:</b>	417 m <sup>3</sup> /hr
<b>Total Capacity of Backwash Water Tanks:</b>	1.25 Mℓ - water obtained from Clear water reservoir
<b>Total Capacity of Sludge Treatment Plant:</b>	1296 kℓ
<b>Capacity of Used Washwater System:</b>	1296 kℓ - Included in the Sludge Lagoons
<b>Primary Post Disinfection Type:</b>	Chlorine gas
<b>Disinfection Dosing Capacity:</b>	0.4 kg/hr
<b>Disinfectant Storage Capacity:</b>	2 820 kg
<b>Total Treated Water Storage Capacity:</b>	1.25 Mℓ Clear water reservoir

**Table 16.17 Pump Details: Middledrift WTP Supply**

System	Pump Station Name	Number of Pumps		Pump Description	Supply From	Supply To	Static Head (m)	Duty Head (m)	Duty Capacity (ML/day)
		Number of Duty Pumps	Number of Standby Pumps						
uMhlathuze	Madungela Transfer Ph1	2	2	Sulzer SM 302.640	Abstraction	Umkhalazi PS	230	254	86.4
uMhlathuze	KCDM Transfer Pumps	1	1	KSB - WKn 150/6	Abstraction	WTP	233	270	5.7
uMhlathuze	Middledrift	1	1	Grundfos NK 200-450/455	WTP	Middledrift Command	60.6	70	10.3

**Table 16.18 Pipeline Details: Middledrift WTP Supply**

System	Pipeline Name	From	To	Length (km)	Nominal Diameter (mm)	Material	Capacity (ML/day)	Age (years)
uMhlathuze	Raw Water Transfer <sup>1</sup>	Thukela River	Middledrift	12.6	1500	Steel	86.4	24
uMhlathuze	Supply to WTP	Transfer take-off	Middledrift WTP	0.16	500	DI	25	9
uMhlathuze	Middledrift Res supply	Middledrift WTP	Middledrift Command	0.5	500	DI	25	9

<sup>1</sup>This pipeline is the raw water transfer to Goedertrouw Dam.

**Table 16.19 Reservoir Details: Middledrift WTP Supply**

System	Reservoir Site	Reservoir Name	Capacity (ML)	Function	TWL (mASL)	FL (mASL)
uMhlathuze	WTP	Middledrift Command	6.0	Balancing	487.7	480.5

## (d) Greater Mthonjaneni Water Treatment Plant and Supply System

The Goedertrouw Dam remains the most viable water source to the Greater Mthonjaneni, Kwahloko and Eshowe supply areas. Abstraction from the dam is via an existing 1.8 m diameter steel pipe to the Greater Mthonjaneni WTP, from which potable water is distributed to pump stations serving both the northern areas (which form part of the Mthonjaneni Local Municipality) and the southern areas (within the uMlalazi Local Municipality).

The Goedertrouw Dam is on the uMhlathuze River and its yield is augmented by an inter-basin transfer from the uThukela River (described in Section 16.1 above). This transfer scheme includes a second high-lift pump-station (Mkhalazi) at the end of the 1.5 m diameter pipeline, to pump water over the watershed, through an extra rising main and gravity main.

A 450 mm diameter ductile iron rising main from the Greater Mthonjaneni WTP supplies water to a 2.5 Mℓ concrete reservoir and four pump stations (Zigigaya Booster 1, Zigigaya Booster 2, Zimela Booster and PSA). The system supplies Greater Mthonjaneni.

The WTP also supplies south via a 300 mm pipeline (previously a raw water pipeline from Goedertrouw Dam) to Kwahloko. The pipeline extends to Eshowe to supply the Eshowe Command reservoirs. A schematic of the Greater Mthonjaneni WTP Supply System is shown in **Figure 16.21**. The reservoir, pump station and pipeline details are summarised in **Table 16.21**, **Table 16.22** and **Table 16.23**.

The Greater Mthonjaneni WTP is a conventional treatment plant comprising the following process components:

- (i) *Hydraulic rapid mixing*: Raw water for the Greater Mthonjaneni WTP is sourced from Goedertrouw Dam. The pre-treatment process involves polymeric coagulant dosing to aid coagulation followed by hydraulic rapid mixing.
- (ii) *Clarification (sedimentation) tanks*: The coagulated water is controlled through sluice gates and conveyed into two clari-flocculators. The flocs that have formed are then settled in the sedimentation tanks under gravity. Sludge from each of the clari-flocculators and spent backwash water is discharged into three sludge lagoons.
- (iii) *Rapid Gravity Sand Filtration*: The clarified water from the clari-flocculators is then conveyed into five rapid gravity sand filters as a final polishing step before chlorination of the treated water.
- (iv) *Chlorine Contact Tank*: Filtered water from the clear wells is disinfected with chlorine gas. Final water is then stored in a 1 Mℓ onsite reservoir before it is pumped to Kwahloko, Mthonjaneni and Eshowe command reservoirs.



Figure 16.20 Greater Mthonjaneni WTP.

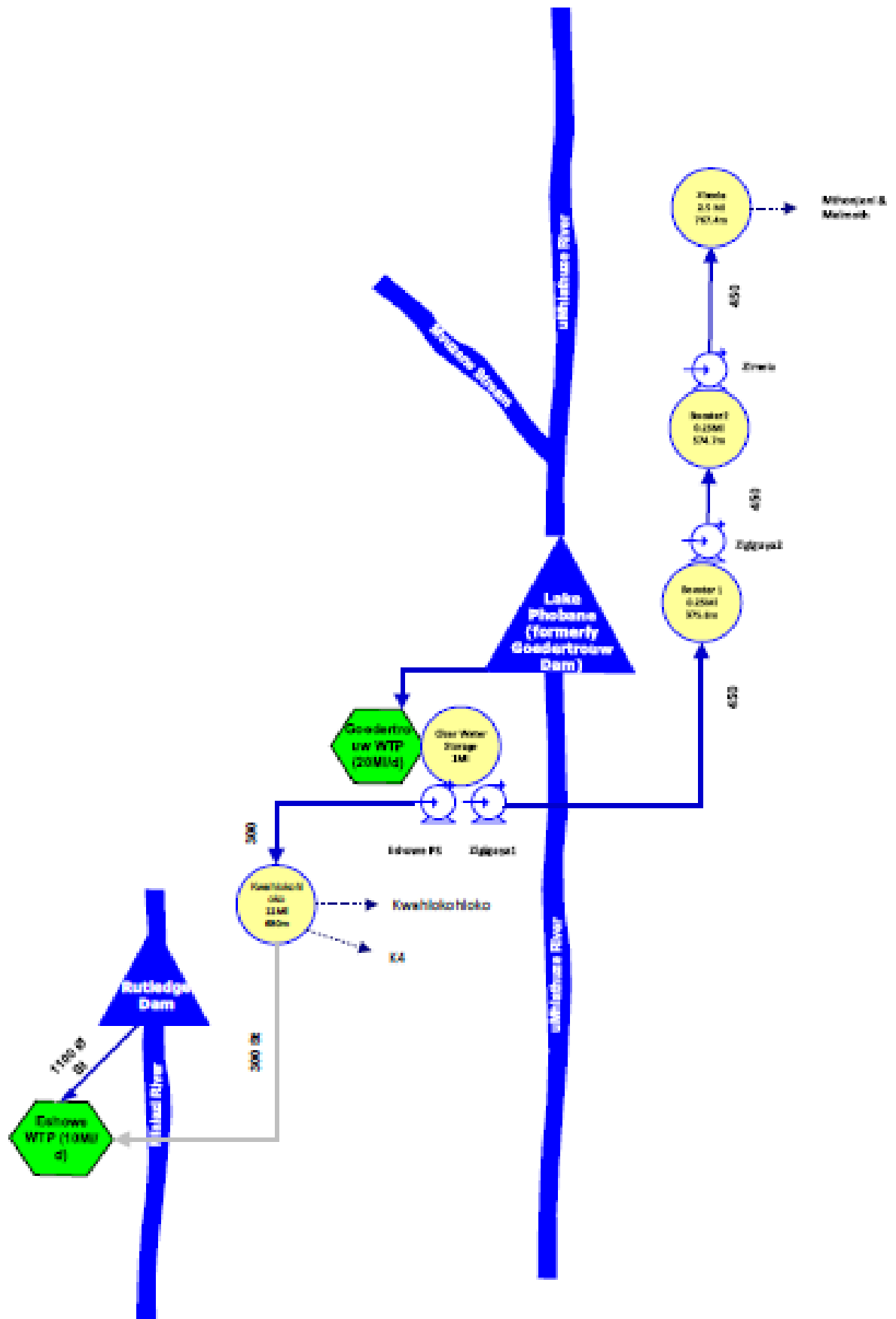

Figure 16.21 Schematic of Goedertrouw Supply System.



**Table 16.20 Characteristics of the Greater Mthonjaneni WTP**

<b>WTP Name:</b>	Greater Mthonjaneni WTP
<b>System:</b>	Goedertrouw Bulk Supply System
<b>Maximum Design Capacity:</b>	20 Mℓ/day
<b>Current Utilisation (January 2020):</b>	14 Mℓ/day
<b>Raw Water Storage Capacity:</b>	0
<b>Raw Water Supply Capacity:</b>	25 Mℓ/day
<b>Pre-Oxidation Type:</b>	None
<b>Primary Water Pre-Treatment Chemical:</b>	SUDFLOC 3450
<b>Total Coagulant Dosing Capacity:</b>	50 ℓ/hr
<b>Rapid Mixing Method:</b>	Compartment Drop
<b>Clarifier Type:</b>	Sedimentation Tanks
<b>Number of Clarifiers:</b>	2
<b>Total Area of all Clarifiers:</b>	780 m <sup>2</sup>
<b>Total Capacity of Clarifiers:</b>	20 Mℓ/day
<b>Filter Type:</b>	Rapid Gravity Sand Filtration
<b>Number of Filters:</b>	5
<b>Filter Floor Type</b>	Monolithic flat panel with underfloor drainage
<b>Total Filtration Area of all Filters</b>	196 m <sup>2</sup>
<b>Total Filtration Design Capacity of all Filters:</b>	20 Mℓ/day
<b>Total Capacity of Backwash Water Tanks:</b>	1 Mℓ
<b>Total Capacity of Sludge Treatment Plant:</b>	Three sludge lagoons
<b>Capacity of Used Washwater System:</b>	Unknown
<b>Primary Post Disinfection Type:</b>	Chlorine Gas
<b>Disinfection Dosing Capacity:</b>	4 kg/hr
<b>Disinfectant Storage Capacity:</b>	6 * 1 Tonne
<b>Total Treated Water Storage Capacity:</b>	1 Mℓ

**Table 16.21 Pump Details: Greater Mthonjaneni WTP Supply**

System	Pump Station Name	Number of Pumps		Pump Description	Supply From	Supply To	Static Head (m)	Duty Head (m)	Duty Capacity (ML/day)
		Number of Duty Pumps	Number of Standby Pumps						
Mthonjaneni	Zigigaya Booster 1	1	1	KSB WKLn 150/5	Goedertrouw WTP	Zigigaya 1	202	211	6.7
Mthonjaneni	Zigigaya Booster 2	1	1	KSB WKLn 150/5	Zigigaya 1	Zigigaya 2	195	211	6.7
Mthonjaneni	Zimela	1	1	KSB WKLn 150/5	Zigigaya 2	Zimela Res	198	211	6.7
Kwahlokhloko	Eshowe	1	1	KSB MTC D 100	Goedertrouw WTP	Kwahlokhloko Res	450	420	4.2

**Table 16.22 Pipeline Details: Greater Mtonjaneni WTP Supply**

System	Pipeline Name	From	To	Length (km)	Nominal Diameter (mm)	Material	Capacity (ML/day)	Age (years)
uMhlathuze	Mthonjaneni Bulk	WTP	Zigigaya Booster 1	2.9	450	Ductile Iron	6.72	13
uMhlathuze	Mthonjaneni Bulk	Zigigaya Booster 1	Zigigaya Booster 2	3.4	450	Ductile Iron	6.72	13
uMhlathuze	Mthonjaneni Bulk	Zigigaya Booster 2	Zimel2 Res	3.6	450	Ductile Iron	6.72	13
uMhlathuze	Kwahlokhloko Bulk	WTP	Kwahlokhloko	10	300	Steel	9.2 <sup>1</sup>	

<sup>1</sup>Capacity based on 1.5m/s velocity

**Table 16.23 Reservoir Details: Goedertrouw WTP Supply**

System	Reservoir Site	Reservoir Name	Capacity (Ml)	Function	TWL (mASL)	FL (mASL)
uMhlathuze	Greater Mthonjaneni WTP	Goedertrouw Potable	1	Balancing	163	160
uMhlathuze	Zigigaya	Zigzag 1	0.25	Pump Suction Storage	375.8	373
uMhlathuze	Zigigaya	Zigzag 2	0.25	Pump Suction Storage	574.7	571
uMhlathuze	Zimele	Zimele Reservoir	2.5	Distribution	767.39	762

### (e) Eshowe Water Treatment Plant and Supply System

The Eshowe Water Supply Scheme comprises of one main treatment works namely the Eshowe town WTP (**Figure 16.22**). The Eshowe WTP abstracts raw water from the Rutledge Park Dam (**Figure 16.7**) through a raw water pumping station at the outlet works of the dam. The supply from the dam to the treatment plant is through a 1.1 m diameter steel pipeline. The Rutledge Park Dam is augmented with raw water from the Ihlazi Dam (**Figure 16.6**). The Rutledge Dam and Ihlazi Dams have a combined historical firm yield of 1.29 million m<sup>3</sup>/a (3.53 Mℓ/day). The Eshowe WTP also receives 4 Mℓ/day potable water from Greater Mthonjaneni WTP via 300mm diameter pipeline. The Eshowe WTP is currently producing 4 Mℓ/day, which is above the design treatment capacity.

The WTP is located within the town of Eshowe and supplies the existing domestic users in Eshowe and the surrounding communities, which is made up of several formal and informal townships in Eshowe and rural villages. The town also has several small industries as well as commercial concerns, businesses and institutions such as the hospital, schools and municipal buildings. Treated water from the Eshowe WTP is pumped from the clearwater tanks to service reservoirs in Eshowe town and surrounding villages to the west and east of the town before distribution to the users (**Figure 16.23**).



**Figure 16.22** The Eshowe WTP.

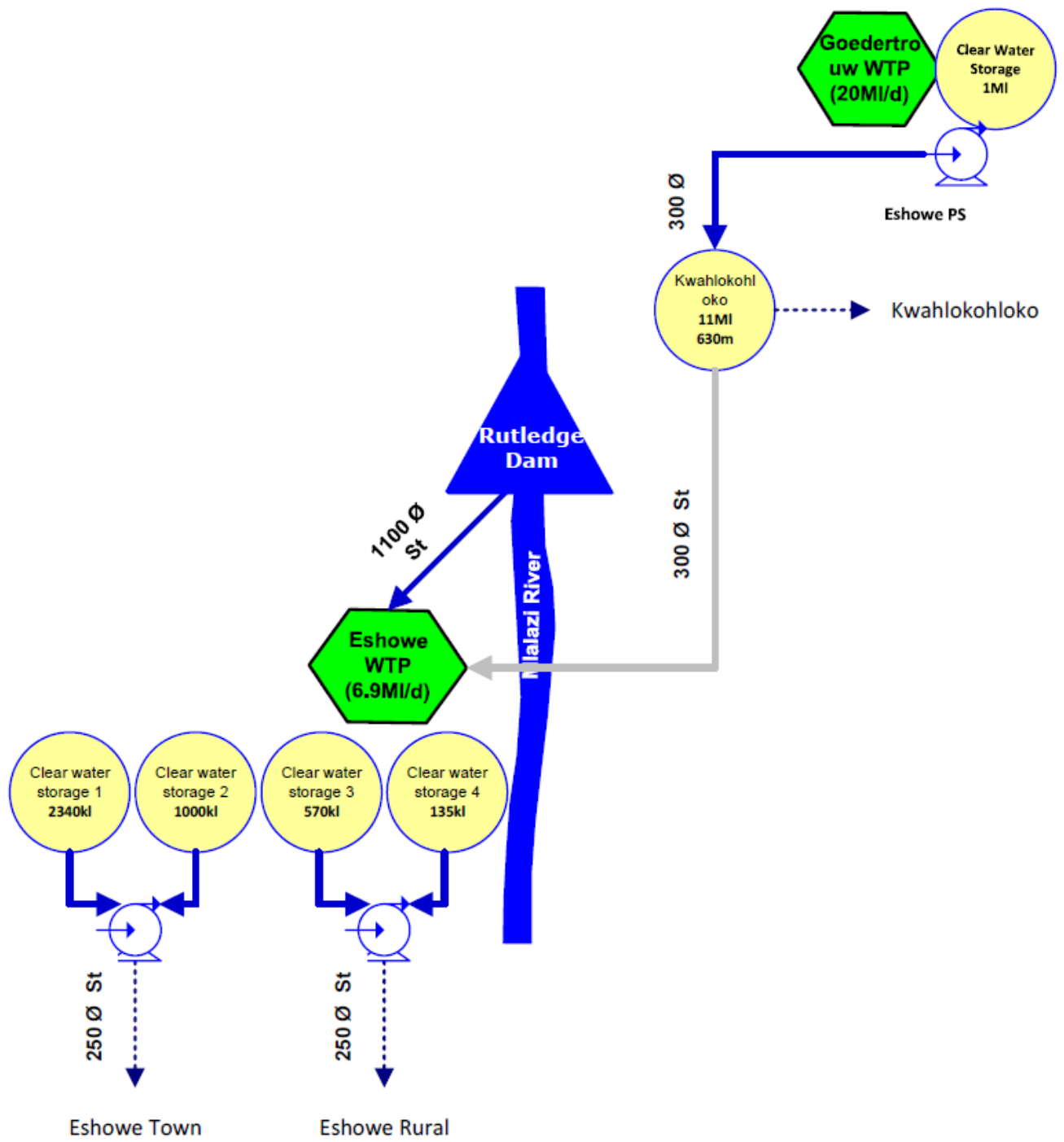

Figure 16.23 Schematic of Eshowe System.

**Table 16.24 Characteristics of the Eshowe WTP**

<b>WTP Name:</b>	Eshowe WTP
<b>System:</b>	Kwahlokohloko Bulk Supply System
<b>Maximum Design Capacity:</b>	10 Mℓ/day
<b>Current Utilisation (June 2022):</b>	7.4 Mℓ/day
<b>Raw Water Storage Capacity:</b>	River Abstraction
<b>Raw Water Supply Capacity:</b>	16 Mℓ
<b>Pre-Oxidation Type:</b>	Flocculation channels
<b>Primary Water Pre-Treatment Chemical:</b>	RHEOFLOC 35643 XI
<b>Total Coagulant Dosing Capacity:</b>	6.94 l/hr (solution flow rate)
<b>Rapid Mixing Method:</b>	Pump diffusion/in-line mixer
<b>Clarifier Type:</b>	Dortmund and Upflow Circular Type Clarifier
<b>Number of Clarifiers:</b>	4
<b>Total Area of all Clarifiers:</b>	565.28 m <sup>2</sup>
<b>Total Capacity of Clarifiers:</b>	10 Mℓ/day
<b>Filter Type:</b>	Rapid Gravity filters & Airlift filters
<b>Number of Filters:</b>	12 no's
<b>Filter Floor Type</b>	Porous concrete floor type
<b>Total Filtration Area of all Filters</b>	1085 m <sup>2</sup>
<b>Total Filtration Design Capacity of all Filters:</b>	10 Mℓ/day
<b>Total Capacity of Backwash Water Tanks:</b>	4 Mℓ Clear water reservoir used for backwashing
<b>Total Capacity of Sludge Treatment Plant:</b>	N/A
<b>Capacity of Used Washwater System:</b>	N/A
<b>Primary Post Disinfection Type:</b>	Chlorine Gas
<b>Disinfection Dosing Capacity:</b>	2.1 kg/hr
<b>Disinfectant Storage Capacity:</b>	1 050 kg
<b>Total Treated Water Storage Capacity:</b>	Eshowe WTP complex 1 x 2.34 Mℓ, 1 x 1 Mℓ, 1 x 0.57 Mℓ, 1 x 0.134 Mℓ

**Table 16.25 Pump Details: Eshowe WTP Supply**

System	Pump Station Name	Number of Pumps		Pump Description	Supply From	Supply To	Static Head (m)	Duty Head (m)	Duty Capacity (Mℓ/day)
		Number of Duty Pumps	Number of Standby Pumps						
Kwahlokoohloko	Rutledge Dam	1	1	KSB Eta 100-250	Rutledge Dam	Eshowe WTP	Unknown	Unknown	Unknown
Kwahlokoohloko	Eshowe	0	1	KSB MTC D 100	Goedertrouw WTP	Kwahlokoohloko Res	450	420	4.2
Kwahlokoohloko	Eshowe WTP	1	1	WILo NL 125/400-08	Eshowe WTP	Eshowe Town	Unknown	Unknown	Unknown
Kwahlokhloko	Eshowe WTP	1	1	Salmron 125-400V-H31/GM	Eshowe WTP	Eshowe Rural	Unknown	Unknown	Unknown

**Table 16.26 Pipeline Details: Eshowe WTP Supply**

System	Pipeline Name	From	To	Length (km)	Nominal Diameter (mm)	Material	Capacity (Mℓ/day)	Age (years)
Kwahlokoohloko	Kwahlokoohloko Bulk	Rutledge Dam	Eshowe WTP	4	1100	Steel	123.16 <sup>1</sup>	Unknown
uMhlathuze	Kwahlokoohloko Bulk	Goedertrouw WTP	Eshowe WTP	10	300	Steel	9.2 <sup>1</sup>	Unknown
Kwahlokoohloko	Kwahlokoohloko Bulk	Eshowe WTP	Eshowe Town		250	PVC	6.36 <sup>1</sup>	Unknown
Kwahlokoohloko	Kwahlokoohloko Bulk	Eshowe WTP	Eshowe Rural		250	PVC	6.36 <sup>1</sup>	Unknown

<sup>1</sup>Capacity based on 1.5m/s velocity

**Table 16.27 Reservoir Details: Eshowe WTP Supply**

System	Reservoir Site	Reservoir Name	Capacity (Mℓ)	Function	TWL (mASL)	FL (mASL)
uMhlathuze	Greater Mthonjaneni WTP	Goedertrouw Potable	1	Balancing	163	160
Kwahlokoheko	Eshowe WTP	Eshowe Potable 1	2.5	Balancing	Unknown	Unknown
Kwahlokoheko	Eshowe WTP	Eshowe Potable 2	1	Balancing	Unknown	Unknown
Kwahlokoheko	Eshowe WTP	Eshowe Potable 3	0.5	Balancing	Unknown	Unknown
Kwahlokoheko	Eshowe WTP	Eshowe Potable 4	0.2	Balancing	Unknown	Unknown



## (f) Ngwelezane Water Treatment Plant and Supply System (CoU)

Ngwelezane and Madlebe towns are supplied from the Ngwelezane WTP (**Figure 16.24** and **Table 16.28**). Ngwelezane WTP abstracts water from the uMhlathuze River upstream of the uMhlathuze Weir on the border with uMlalazi LM. The communities are supplied via three (3) reservoirs located on the edge of town. The WTP has a capacity of 8 Mℓ/day and operates at full capacity.



**Figure 16.24 Ngwelezane WTP.**

The Ngwelezane WTP and Supply System is shown in **Figure 16.25**.

Water is abstracted from the left bank of the uMhlathuze River and pumped to the WTP located on the river bank. A 250 mm diameter pipeline from the works feeds the 13.4 Mℓ Ngwelezane Bulk Reservoir. The reservoir supplies the Ngwelezane community.

The reservoir, pump station and pipeline details are summarised in **Table 16.29**, **Table 16.30** and **Table 16.31**.

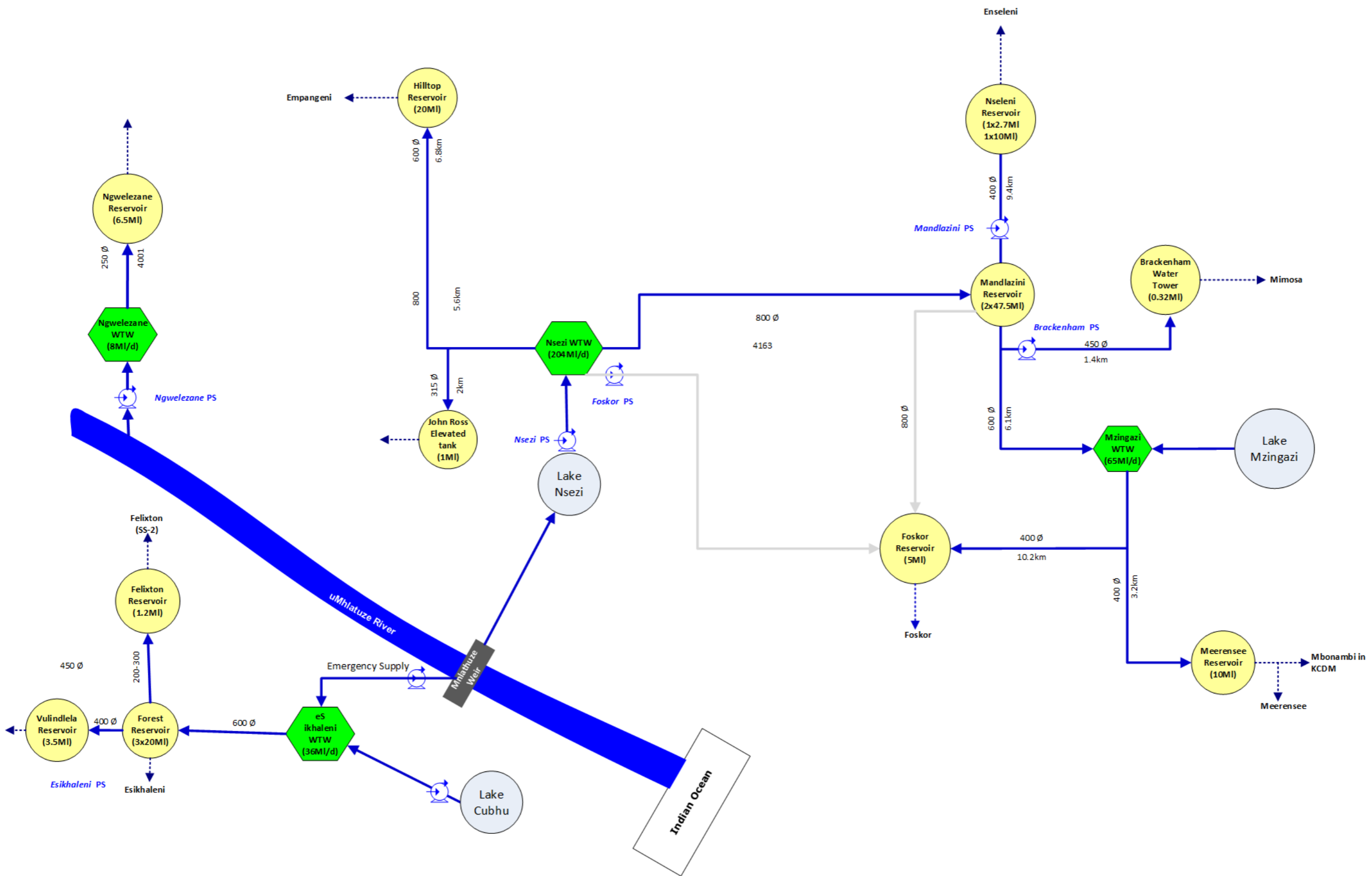

Figure 16.25 Schematic of CoU System

**Table 16.28 Characteristics of the Ngwelezane WTP**

<b>WTP Name:</b>	Ngwelezane WTP
<b>System:</b>	Ngwelezane Bulk Supply System
<b>Maximum Design Capacity:</b>	8 Mℓ/day stated (possibly up to 10 Mℓ/day)
<b>Current Utilisation (January 2022):</b>	Unknown
<b>Raw Water Storage Capacity:</b>	River Abstraction
<b>Raw Water Supply Capacity:</b>	8 Mℓ/day
<b>Pre-Oxidation Type:</b>	Flocculation channels
<b>Primary Water Pre-Treatment Chemical:</b>	Lime
<b>Total Coagulant Dosing Capacity:</b>	Unknown
<b>Rapid Mixing Method:</b>	Unknown
<b>Clarifier Type:</b>	n/a
<b>Number of Clarifiers:</b>	n/a
<b>Total Area of all Clarifiers:</b>	Horizontal Flow Sedimentation tanks 14 x 7.5 m
<b>Total Capacity of Clarifiers:</b>	Two No's with total capacity of +/- 10-11.5 Mℓ/day
<b>Filter Type:</b>	Rapid Gravity filters
<b>Number of Filters:</b>	3 no's
<b>Filter Floor Type</b>	Unknown
<b>Total Filtration Area of all Filters</b>	5m x 4 m x 3 no's = 60 sqm
<b>Total Filtration Design Capacity of all Filters:</b>	8 Mℓ/day
<b>Total Capacity of Backwash Water Tanks:</b>	Unknown
<b>Total Capacity of Sludge Treatment Plant:</b>	Sludge Lagoons
<b>Capacity of Used Washwater System:</b>	Unknown
<b>Primary Post Disinfection Type:</b>	Chlorine Gas
<b>Disinfection Dosing Capacity:</b>	Unknown
<b>Disinfectant Storage Capacity:</b>	Unknown
<b>Total Treated Water Storage Capacity:</b>	Ngwelezana complex 2x1.68 Mℓ, 1 x 6.5 Mℓ, 1 x 3.5 Mℓ

**Table 16.29 Pump Details: Ngwelezane WTP Supply**

System	Pump Station Name	Number of Pumps		Pump Description	Supply From	Supply To	Static Head (m)	Duty Head (m)	Duty Capacity (Ml/day)
		Number of Duty Pumps	Number of Standby Pumps						
uMhlathuze	Ngwelezane Abstraction	tbc	tbc	tbc	uMhlathuze River	Ngwelezane WTP	8	tbc	tbc
uMhlathuze	Ngwelezane	4	0	WKLN 125/5	Ngwelezane WTP	Ngwelezane Res	175	160	4.8

**Table 16.30 Pipeline Details: Ngwelezane WTP Supply**

System	Pipeline Name	From	To	Length (km)	Nominal Diameter (mm)	Material	Capacity (Ml/day)	Age (years)
uMhlathuze	Ngwelezane Bulk	Ngwelezane WTP	Ngwelezane Res	4	250	tbc	6.4	tbc

**Table 16.31 Reservoir Details: Ngwelezane WTP Supply**

System	Reservoir Site	Reservoir Name	Capacity (Ml)	Function	TWL (mASL)	FL (mASL)
uMhlathuze	Ngwelezane	Ngwelezane	13.4	tbc	115	110

### (g) eSikhaleni Water Treatment Plant and Supply System (CoU)

The eSikhaleni WTP (**Figure 16.26** and **Table 16.32**) sources water from Lake Cubhu and is supplemented from the uMhlathuze Weir. It supplies Esikhawini, Vulindlela and surrounding industries, i.e. Mondi Felixton and Tongaat-Hulett.

An emergency pipeline exists between the uMhlathuze Weir and the eSikhaleni WTP for use during times when the Lake Cubhu water level is too low for abstraction. The lake is generally preferred as a water source for the municipality, since the river abstraction requires pumping, which has cost implications. The WTP has a capacity of 36 Mℓ/day.

Historically eSikhaleni WTP relied completely on Lake Cubhu as a source. Serious problems were experienced during the 1992/94 drought, with low lake levels and an augmented supply from the uMhlathuze River was implemented. The scheme from the uMhlathuze River was implemented as part of the Iscor Mining water supply scheme, and was completed during May/June 2001. This system has a capacity of 34 Mℓ/day.

Due to the decreasing lake levels, as from August 2014, eSikhaleni WTP was supplemented with 7.5Mℓ/day (raw water from uMhlathuze Water Weir Pump Station) and this volume was increased gradually to a maximum system capacity of 30Mℓ/day in January 2015.



**Figure 16.26 eSikhaleni WTP.**

The eSikhaleni WTP Supply System is shown in **Figure 16.25** and the details of the WTP is shown in **Table 16.32**. The reservoir, pump station and pipeline details are summarised in **Table 16.33**, **Table 16.34** and **Table 16.35**.

**Table 16.32 Characteristics of the eSikhaleni WTP**

<b>WTP Name:</b>	eSikhaleni WTP
<b>System:</b>	eSikhaleni Bulk Supply System
<b>Maximum Design Capacity:</b>	36 Mℓ/day
<b>Current Utilisation (January 2021):</b>	36 Mℓ/day
<b>Raw Water Storage Capacity:</b>	Lake Chubu
<b>Raw Water Supply Capacity:</b>	36 Mℓ/day
<b>Pre-Oxidation Type:</b>	Flocculation channels
<b>Primary Water Pre-Treatment Chemical:</b>	Lime
<b>Total Coagulant Dosing Capacity:</b>	Unknown
<b>Rapid Mixing Method:</b>	Concrete inlet chamber
<b>Clarifier Type:</b>	4 No's Horizontal flow tanks 11x38m each
<b>Number of Clarifiers:</b>	4
<b>Total Area of all Clarifiers:</b>	1675 sqm
<b>Total Capacity of Clarifiers:</b>	36 Mℓ/day
<b>Filter Type:</b>	Rapid gravity ( dual media)
<b>Number of Filters:</b>	8 Rapid Gravity filters
<b>Filter Floor Type</b>	False Floor
<b>Total Filtration Area of all Filters</b>	8m x 5 m x 8No's 40 sqm each
<b>Total Filtration Design Capacity of all Filters:</b>	36 Mℓ/day
<b>Total Capacity of Backwash Water Tanks:</b>	Unknown
<b>Total Capacity of Sludge Treatment Plant:</b>	Sludge Lagoons
<b>Capacity of Used Washwater System:</b>	Unknown
<b>Primary Post Disinfection Type:</b>	Chlorine Gas
<b>Disinfection Dosing Capacity:</b>	Unknown
<b>Disinfectant Storage Capacity:</b>	Unknown
<b>Total Treated Water Storage Capacity:</b>	Esikhaleni = 3 x 20 Mℓ/day ,

**Table 16.33 Pump Details: eSikhaleni WTP Supply**

System	Pump Station Name	Number of Pumps		Pump Description	Supply From	Supply To	Static Head (m)	Duty Head (m)	Duty Capacity (Mℓ/day)
		Number of Duty Pumps	Number of Standby Pumps						
uMhlathuze	Esikhaleni High Lift Pump station	3	1	Sulzer Weir, Centrifugal Pumps	Treatment Plant	Storage Reservoir	125	130	13

**Table 16.34 Pipeline Details: eSikhaleni WTP Supply**

System	Pipeline Name	From	To	Length (km)	Nominal Diameter (mm)	Material	Capacity (Mℓ/day)	Age (years)
uMhlathuze		eSikhaleni WTP	Forrest Reservoir	9.3	600		34	21

**Table 16.35 Reservoir Details: eSikhaleni WTP Supply**

System	Reservoir Site	Reservoir Name	Capacity (Mℓ)	Function	TWL (m ASL)	FL (m ASL)
uMhlathuze		Forrest Reservoir	60	Balancing	135	130



## (h) Nsezi Water Treatment Plant and Supply System (CoU)

The primary supply for Nsezi WTP is Lake Nsezi. The yield is supplemented by transfers from the uMhlathuze River at uMhlathuze Weir (**Figure 16.27**). uMhlathuze Weir relies on releases from Goedertrouw Dam (owned and operated by DWS). Water is released from the dam and flows for about 90 km to a weir owned and operated by Mhlathuze Water. From the weir, water is pumped into Lake Nsezi, which acts as balancing storage for Mhlathuze Water's Nsezi WTP (**Figure 16.28**). The WTP was recently upgraded and now has a capacity of 204 Mℓ/day.

This WTP is the most significant in CoU and supplies Empangeni, Richards Bay, and Ngwelezane. An 800 mm diameter pipeline, from the WTP, supplies the 20 Mℓ Hilltop Reservoir which supplies Empangeni. There is also an 800 mm diameter pipeline supplying Mandlazini Command Reservoir that serves Richards Bay.



**Figure 16.27** uMhlathuze Weir.



**Figure 16.28 Nsezi WTP.**

The Nsezi WTP Supply System is shown in **Figure 16.25** and details of the WTP is shown in **Table 16.36**.

The reservoir, pump station and pipeline details are summarised in **Table 16.37**, **Table 16.38** and **Table 16.39**.

**Table 16.36 Characteristics of the Nsezi WTP**

<b>WTP Name:</b>	Nsezi WTP
<b>System:</b>	Nsezi Bulk Supply System
<b>Maximum Design Capacity:</b>	204 Mℓ/day
<b>Current Utilisation (January 2021):</b>	190 Mℓ/day
<b>Raw Water Storage Capacity:</b>	Lake Nsezi, Mhlthuze River, Goedertrouw system
<b>Raw Water Supply Capacity:</b>	333 Mℓ/day
<b>Pre-Oxidation Type:</b>	Unknown
<b>Primary Water Pre-Treatment Chemical:</b>	Unknown
<b>Total Coagulant Dosing Capacity:</b>	Alum and Polyelectrolyte
<b>Rapid Mixing Method:</b>	Concrete Flash mixing chamber & Flocculation conditioning
<b>Clarifier Type:</b>	1 no's 34 m dia , 2 no's 48 m dia
<b>Number of Clarifiers:</b>	3No's
<b>Total Area of all Clarifiers:</b>	3970 sqm
<b>Total Capacity of Clarifiers:</b>	210 Mℓ/day
<b>Filter Type:</b>	Degramont V type – Rapid Gravity
<b>Number of Filters:</b>	12 filters
<b>Filter Floor Type</b>	Unknown
<b>Total Filtration Area of all Filters</b>	17.5 m x 8 m x 12 No's = 1680 sqm
<b>Total Filtration Design Capacity of all Filters:</b>	202 Mℓ/day
<b>Total Capacity of Backwash Water Tanks:</b>	Unknown
<b>Total Capacity of Sludge Treatment Plant:</b>	Unknown
<b>Capacity of Used Washwater System:</b>	Unknown
<b>Primary Post Disinfection Type:</b>	Chlorine Gas and Caustic Soda
<b>Disinfection Dosing Capacity:</b>	Unknown
<b>Disinfectant Storage Capacity:</b>	Unknown
<b>Total Treated Water Storage Capacity:</b>	Unknown

**Table 16.37 Pump Details: Nsezi WTP Supply**

System	Pump Station Name	Number of Pumps		Pump Description	Supply From	Supply To	Static Head (m)	Duty Head (m)	Duty Capacity (Mℓ/day)
		Number of Duty Pumps	Number of Standby Pumps						
uMhlathuze	Empangeni	2	1		Nsezi	Empangeni/Hillview	120	158	52

**Table 16.38 Pipeline Details: Nsezi WTP Supply**

System	Pipeline Name	From	To	Length (km)	Nominal Diameter (mm)	Material	Capacity (Mℓ/day)	Age (years)
uMhlathuze	Mandlazini Supply	Nsezi WTP	Pierce Cres. Res.	5.7/1.8	800/600	Steel	65/37	
uMhlathuze	Empangeni Supply	T-off	Hilltop Res.	1.5	600	Steel	37	

**Table 16.39 Reservoir Details: Nsezi WTP Supply**

System	Reservoir Site	Reservoir Name	Capacity (Mℓ)	Function	TWL (m ASL)	FL (m ASL)
uMhlathuze	Hilltop	Hilltop Reservoir	60	Distribution	135	130

### (i) Mzingazi Water Treatment Plant and Supply System (CoU)

Mzingazi WTP (**Figure 16.29**) has a capacity of 65 Ml/day. Raw water is abstracted from Lake Mzingazi, which is then treated and distributed into Richards Bay and the industrial areas. The industrial area within the city of Richards Bay includes the Alton area, where Mondi, Hillside and Bayside Aluminium and Foskor are located. The residential suburbs include Meerensee, Arboretum and Veld en Vlei and the commercial/ light-industrial centre. Both residential and commercial / light industry, are supplied from the Mzingazi WTP, and supplemented, when necessary, from the Nsezi WTP. The rural town of Nseleni is also supplied via this scheme.

Mzingazi WTP supplies two command reservoirs, namely Mandlazini and Meerensee Reservoirs.

The Mzingazi WTP Supply System is shown in **Figure 16.25** and details of the WTP is shown in **Table 16.40**.

The reservoir, pump station and pipeline details are summarised in **Table 16.41**, **Table 16.42** and **Table 16.43**.



**Figure 16.29 Mzingazi WTP**

**Table 16.40 Characteristics of the Mzingazi WTP**

<b>WTP Name:</b>	Mzingazi WTP
<b>System:</b>	Mzingazi Bulk Supply System
<b>Maximum Design Capacity:</b>	65 Mℓ/day
<b>Current Utilisation (January 2023):</b>	Unknown
<b>Raw Water Storage Capacity:</b>	Mzingazi Lake 164 sq/km 47.6 million cubic meters per year
<b>Raw Water Supply Capacity:</b>	The estimated duty of the existing pumps is 1300m <sup>3</sup> /h at a head of 13.5m per pump (3 pumps)
<b>Pre-Oxidation Type:</b>	Unknown
<b>Primary Water Pre-Treatment Chemical:</b>	Lime Dosing & Pre-chlorination
<b>Total Coagulant Dosing Capacity:</b>	Unknown
<b>Rapid Mixing Method:</b>	Unknown
<b>Clarifier Type:</b>	N/A
<b>Number of Clarifiers:</b>	N/A
<b>Total Area of all Clarifiers:</b>	N/A
<b>Total Capacity of Clarifiers:</b>	N/A
<b>Filter Type:</b>	Rapid gravity ( dual media)
<b>Number of Filters:</b>	8 Rapid Gravity filters
<b>Filter Floor Type</b>	False Floor
<b>Total Filtration Area of all Filters</b>	9m x 7.5 m x 8No's = 67.5 sqm. each
<b>Total Filtration Design Capacity of all Filters:</b>	36 Mℓ/day
<b>Total Capacity of Backwash Water Tanks:</b>	Unknown
<b>Total Capacity of Sludge Treatment Plant:</b>	Unknown
<b>Capacity of Used Washwater System:</b>	Unknown
<b>Primary Post Disinfection Type:</b>	Chlorine Gas
<b>Disinfection Dosing Capacity:</b>	Unknown
<b>Disinfectant Storage Capacity:</b>	Unknown
<b>Total Treated Water Storage Capacity:</b>	Mandlazini 2 x 47.5 Mℓ & Meerensee 1 x 10 Mℓ

**Table 16.41 Pump Details: Mzingazi WTP Supply**

System	Pump Station Name	Number of Pumps		Pump Description	Supply From	Supply To	Static Head (m)	Duty Head (m)	Duty Capacity (Ml/day)
		Number of Duty Pumps	Number of Standby Pumps						
uMhlathuze	Mandlazini	4	1	Samco Vertical turbine	Mzingazi WTP	Mandlazini Res.	54	60	27.7
uMhlathuze	Meerensee	2	1	Samco Vertical turbine	Mzingazi WTP	Meerensee Res	72	67	23.3

**Table 16.42 Pipeline Details: Mzingazi WTP Supply**

System	Pipeline Name	From	To	Length (km)	Nominal Diameter (mm)	Material	Capacity (Ml/day)	Age (years)
uMhlathuze	Meerensee Pipeline	Mzingazi WTP	Meerensee Res.	3.2	400	Steel	16.3	
uMhlathuze	Mandlazini Pipeline	Mzingazi WTP	Mandlazini Res.	6.1	600	Steel	36.7	

**Table 16.43 Reservoir Details: Mzingazi WTP Supply**

System	Reservoir Site	Reservoir Name	Capacity (Ml)	Function	TWL (m ASL)	FL (m ASL)
uMhlathuze	Meerensee	Meerensee	10	Distribution	51	47
uMhlathuze	Mandlazini	Mandlazini	95	Distribution	67	62

## 16.3.2 Status Quo and Limitations of the uMhlatuze System

### (a) Nkandla Water Treatment Plant and Supply System

The WTP is currently operating at 3.22 ML/day (Figure 16.30), which is within its design treatment capacity (3.6 ML/day). The demand in this area is now constrained by the WTP capacity. The existing bulk treated water supply capacity is not sufficient to meet future water requirements of the Nkandla Water Supply Scheme.

Apart from the Nkandla System, there are numerous boreholes, springs and minor river abstractions that serve the Nkandla Local Municipality. These standalone schemes do not have a sustainable supply and are also an operational challenge. There is a need to consolidate these schemes into a more sustainable bulk supply system. The population in the region is projected to be 128 694 in 2050 with a total demand of 24 ML/day. The current Nkandla Supply System cannot meet this demand. A new resource will have to be developed to ensure a sustainable future supply. In addition, an assessment of the maximum potential yield from the existing resource should be established to evaluate the potential of upgrading the WTP.

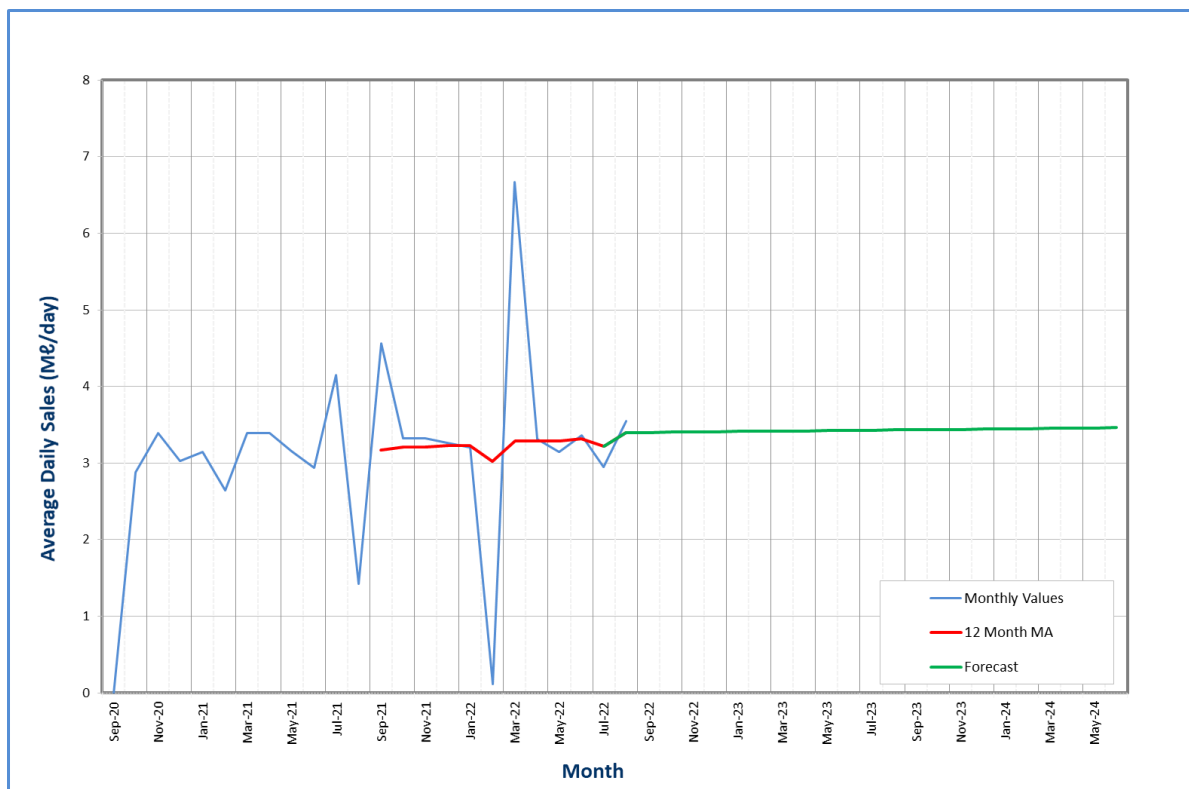

Figure 16.30 Water demand for Nkandla WTP



## (b) Middledrift Water Treatment Plant and Supply System

The water treatment plant is operating at approximately 9.87 Mℓ/day (Figure 16.31). The plant is approaching its capacity (10 Mℓ/day) and will need to be upgraded as some months it exceeds the design capacity. Supply to the WTP is heavily dependent on the operation of the uThukela Goedertrouw Transfer Scheme. There is a need for a dedicated supply to this plant to alleviate this dependency. This will require new pump stations and a dedicated raw water pipeline. In addition, a formal water resource structure should be established to improve the assurance of raw water availability.

KCDM is in the process of implementing secondary bulk infrastructure that relies on supply from this water treatment plant. As the supply increases, there will be a need to upgrade the bulk supply infrastructure and treatment capacity. The population in the region is projected to be 106 063 in 2050 with a total demand of 19.71 Mℓ/day.

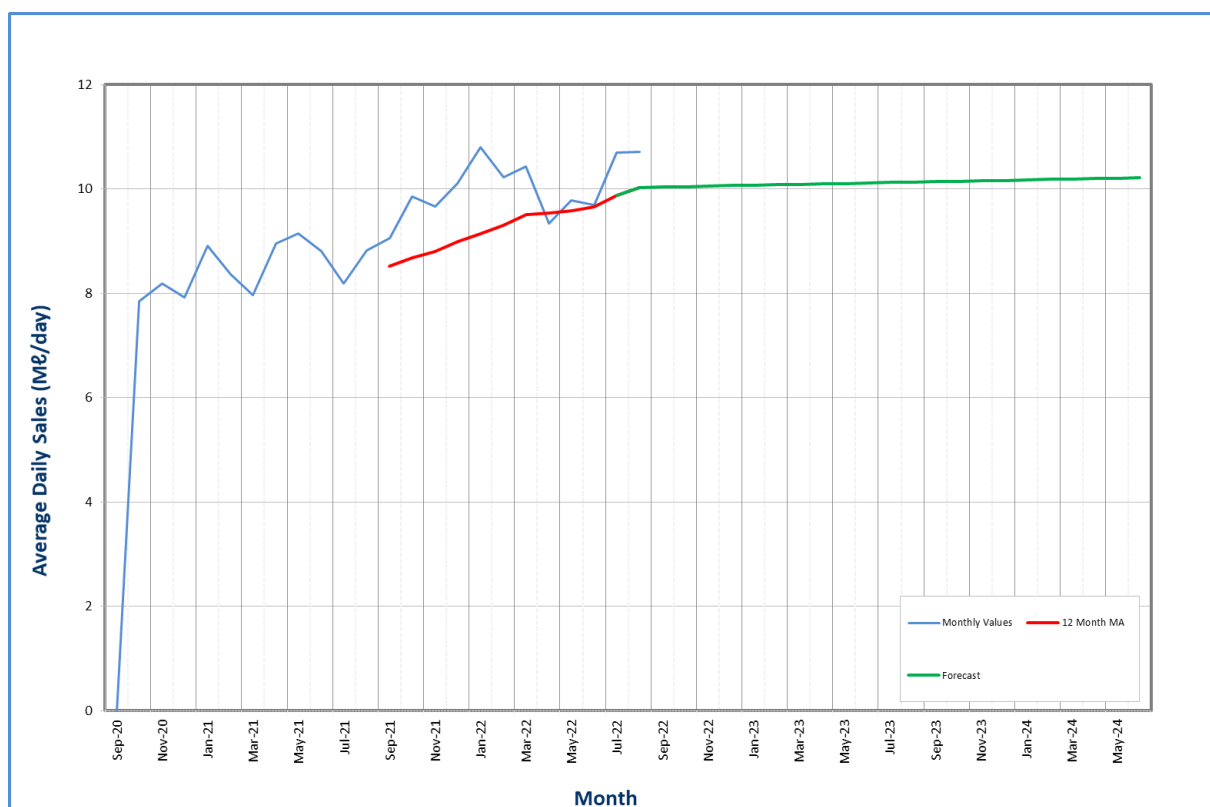

Figure 16.31 Water demand for Middledrift WTP

## (c) Greater Mthonjaneni Water Treatment Plant and Supply System

The current utilisation of the plant is 9.55 Mℓ/day (Figure 16.32). The plant is approaching its capacity and will need to be upgraded. KCDM have appointed a PSP to upgrade the plant in phases to its maximum capacity of 80 Mℓ/day. The first phase, which will take the capacity to 40 Mℓ/day, is being designed and construction will likely be completed by 2025.

The Goedertrouw Supply System has three bulk supply zones which includes Mthonjaneni, Kwahloko and Eshowe. Mthonjaneni to the north is expected to have a population of 113 317 in 2050 with a total demand of 22.02 Mℓ/day. The bulk infrastructure for this system is currently being completed in order to ensure that the 2050 water demand is met.

The supply to the south is to Kwahloko. The Kwahloko Water Supply area is supplied by the Mpungose command reservoir which gets its potable water from Greater Mthonjaneni WTP. The scheme has a number of smaller schemes abstracting from run-of-river abstractions (e.g. Gingindlovu Water Supply Scheme) or from boreholes. The scheme supplies a rudimentary level of service. There are plans (currently at design phase and some at construction phase) to develop a bulk supply system from Greater Mthonjaneni WTP into Kwahloko and further on to Eshowe and Gingindlovu.

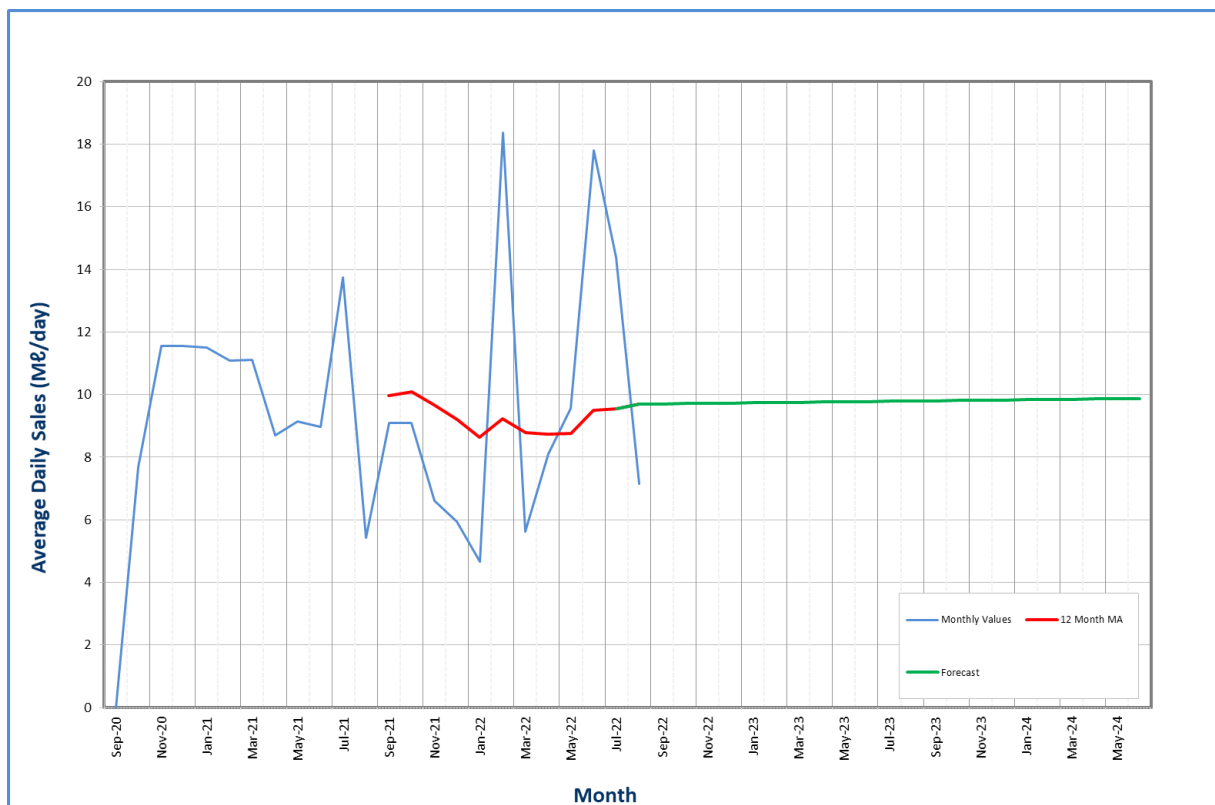

**Figure 16.32 Water demand for Greater Mthonjaneni WTP**

### (d) Eshowe Water Treatment Plant and Supply System

The water treatment plant is currently operating at approximately 3.89 Mℓ/day (**Figure 16.33**). The Universal Access Plan Phase 3 for KCDM reported that the plant has a design capacity of about 6.9 Mℓ/day. The existing raw water abstraction works, including the raw water pumps, have sufficient capacity to meet the hydraulic design requirements of the existing WTP. Eshowe WTP also receives 4 Mℓ/day potable water from Greater Mthonjaneni WTP via a 300mm diameter pipeline.

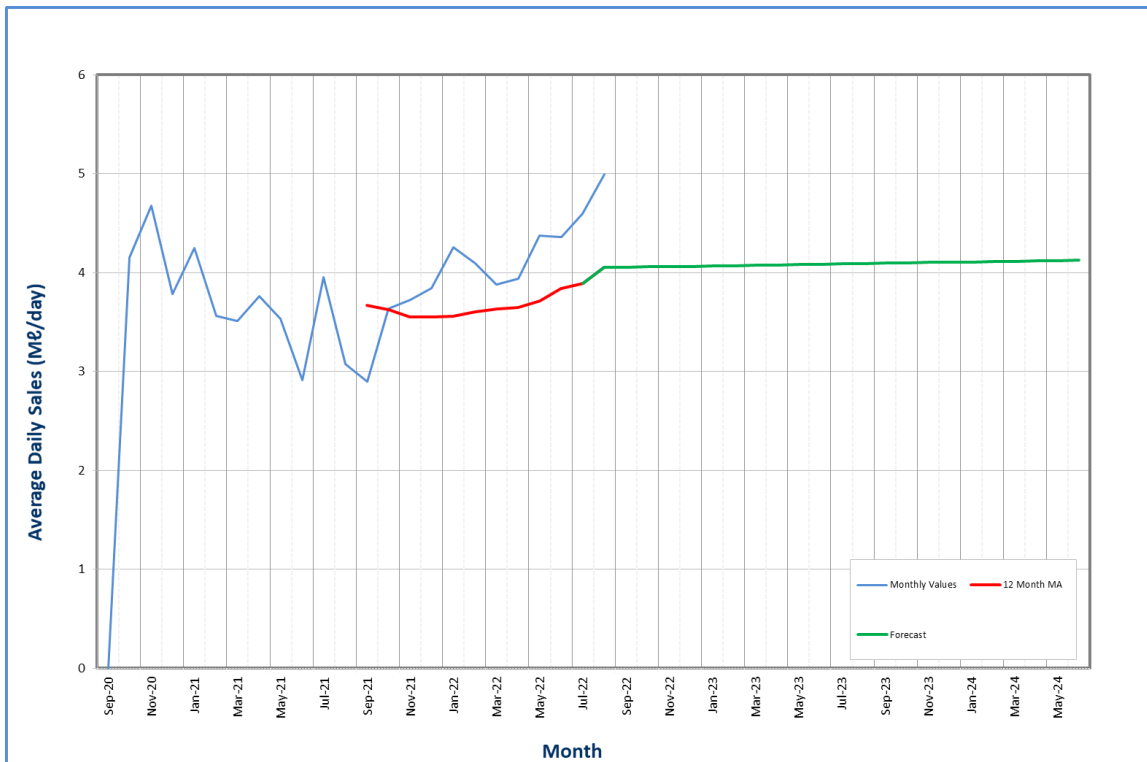

**Figure 16.33 Water demand for Eshowe WTP**

### (e) City of uMhlathuze Bulk Water Supply

The WTP’s in CoU are integrated and a review of the sustainable approach to bulk water supply in CoU suggests that a more optimum usage of the plants are required. This is also guided by the depletion of some of the lakes. The existing WTPs were used as the basis to establishing future water supply arrangements.

CoU currently has four (4) WTPs that are considered to be in operating condition. Nsezi WTP serves as a redundancy to Mzingazi WTP and Ngwelezane WTP by supplementing the Northern and Western areas when required. During the recent drought, in 2015, the low water levels in Lake Mzingazi, Lake Nsezi and Lake Chubu resulted in the Nsezi WTP being used to serve the aforementioned resources’ supply areas. This, in reality, meant the plants were being operated as one scheme.

The Nsezi WTP is operating at 190 Ml/day on average. This is 95% of its capacity. There is an urgent need to upgrade the plant to reduce the risk of non-supply. This plant is a key supply to the region and serves as a back up to supply the Mzingazi Supply System which carries the risk of an erratic supply from Lake Mzingazi.

The draft Water and Waste Water Master Plan by Mhlathuze Water (2016), lists various WTP scenarios for future potable water supply to CoU based on the aforementioned relationships between the existing WTPs. These scenarios are listed in **Table 16.44**.

**Table 16.44 WTP Scenarios in CoU (uMhlathuze Water 2016).**

Scenario	Water Treatment Plant
Scenario A	<ul style="list-style-type: none"> <li>▪ Nsezi WTP (Lake Nsezi supplemented by uMhlathuze Weir)</li> </ul>
Scenario B	<ul style="list-style-type: none"> <li>▪ Nsezi WTP (Lake Nsezi supplemented by uMhlathuze Weir)</li> <li>▪ eSikhaleni WTP (Lake Chubu supplemented by uMhlathuze Weir)</li> </ul>
Scenario C	<ul style="list-style-type: none"> <li>▪ Nsezi WTP (Lake Nsezi supplemented by uMhlathuze Weir)</li> <li>▪ Mzingazi WTP (Lake Mzingazi)</li> <li>▪ eSikhaleni WTP (Lake Chubu supplemented by uMhlathuze Weir)</li> </ul>
Scenario D (Status Quo)	<ul style="list-style-type: none"> <li>▪ Nsezi WTP (Lake Nsezi supplemented by uMhlathuze Weir)</li> <li>▪ Mzingazi WTP (Lake Mzingazi)</li> <li>▪ eSikhaleni WTP (Lake Chubu supplemented by uMhlathuze Weir)</li> <li>▪ Ngwelazane WTP (uMhlathuze River)</li> </ul>

Scenario B is considered the most likely option (UW 2016 : 42). This scenario dictates the suggested upgrades that will be required.

### **(f) Ngwelezane Water Treatment Plant and Supply System**

The existing treatment capacity of the Ngwelezane WTP is 8 Mℓ/day and is supplied from the uMhlathuze River. The current operation of this plant is 13.857 Mℓ/day (CoU IWA water balance spreadsheet, June 2022). This is well above its design capacity.

Ngwelezane WTP is very old and is experiencing many operational problems which, apart from operating above its design capacity, has the following challenges:

- Low water levels in the river resulting in insufficient flow to the intake tower;
- Variable sand and silt levels in the river. This not only results in problems at the abstraction but high turbidity levels at the plant;
- Pump damage during flooding.

Given the age of the works and the relatively small amount of water it supplies, the plans by CoU is to decommission the works and supply this system from the Nsezi WTP. There are inter-connections between these systems that will allow a quick change to introduce this operational regime. The load transfer is, however, dependant on the upgrade of the treatment capacity of the Nsezi WTP.

Alternatively, the Ngwelezane WTP can be upgraded to 20 Mℓ/day and the bulk conveyance and storage infrastructure can also be upgraded to ensure that the current and future demands are met.

### **(g) eSikhaleni Water Treatment Plant and Supply System**

The current treatment capacity of the eSikhaleni WTP is 36 Mℓ/day. The current operation of this plant is 29.036 Mℓ/day (CoU IWA water balance spreadsheet, June 2022) which is 80% of its maximum operating capacity and equivalent to its design capacity.

After consolidation of the WTPs, eSikhaleni WTP will supply the northern and western areas of CoU. There is no redundancy for good operating practices such as taking filters offline for cleaning.

The plant relies on Lake Chubu, augmented by a supply from the uMhlathuze River at the Weir. There is an increased reliance on the uMhlathuze weir. This has resulted in an increased cost to produce potable water due to the pumping required.

The plant supplies the eastern portion of KCDM and the ideal solution is to load-shed this zone onto a different supply system.

## **(h) Nsezi Water Treatment Plant and Supply System**

The current treatment capacity of the Nsezi WTP is 205 Mℓ/day. The Nsezi WTP is operating at an average of 190 Mℓ/day (CoU IWA water balance spreadsheet, March 2020, no further information was available at this time) which is 95% of its maximum design capacity. This is equivalent to its design capacity.

After consolidation of the WTPs, Nsezi WTP will supply the southern areas of CoU. The Ngwelezane, eSikhaleni and Mzingazi Water Treatment Plant Supply zones are planned to eventually be supplied from Nsezi WTP. The long term demand is anticipated to be approximately 240 Mℓ/day. Included in this estimate is the supply of 90 Mℓ/day and 21 Mℓ/day to Mondi and Foskor respectively. Richards Bay Minerals utilises raw water and is excluded from these demands. This should, however, need to be considered in the resource calculations.

Nsezi is a key water treatment plant in the supply of potable water to CoU. The resource to supply this plant with adequate raw water is critical. The primary supply is from the uMhlathuze weir with the assurance of supply from Goedertrouw Dam via controlled releases. This, however, is not enough to meet the long term demands and other resources are required to augment supply to the plant. The resource options are discussed in the recommended projects section of this report. **(Section 16.5.1(e))**

## **(i) Mzingazi Water Treatment Plant and Supply System**

The biggest concern with regards to the Mzingazi WTP is the supply of raw water from Lake Mzingazi. During droughts, the lake level drops, resulting in very little or no water flow to the intake tower. This has an impact on the treatment capacity of the works. Historical figures indicate a reduction in capacity to zero. This occurred during the drought of 2011/12 and has since occurred more frequently. This has resulted in an increased reliance on supply from Nsezi WTP.

When there is sufficient supply from Lake Mzingazi, raw water from Lake Mzingazi (HFY of 10.5 million m<sup>3</sup>/a or 28.77 Mℓ/day) is abstracted and is treated at the Mzingazi WTP for distribution into Richards Bay and the Industrial areas. The Mzingazi WTP has an existing treatment capacity of 65 Mℓ/day and cannot be upgraded in future due to the HFY of Lake Mzingazi that restricts the allocation to 28.77 Mℓ/day.

Because there is a low assurance of raw water supply to the plant, any upgrades to this plant is not prudent. Ultimately, this supply zone will be permanently supplied from Nsezi WTP.

## 16.4 Water Balance/Availability

Both the Eshlazi and Rutledge Park Dams operate as a unit and their combined firm yield is 1.29 million m<sup>3</sup> (3.53 Mℓ/day) according to DWS (2016). The firm yield of the uMhlathuze System is 248 million m<sup>3</sup>/annum and includes a combination of yields from Goedertrouw Dam, Coastal Lakes, tributary flows captured at the uMhlathuze weir and the existing uThukela Transfer Scheme (DWS, 2020).

The DWS, 2020 report concludes that:

- The existing water resources in the uMhlathuze System are sufficient to supply demands until the year 2021 at a satisfactory assurance of supply.
- The additional water available to the system, when the Thukela transfer is increased, is equal to 45 million m<sup>3</sup>/annum. This is more than the actual increased transfer volume and can only be achieved if the system is operated in an efficient manner, including leaving water in the Goedertrouw Dam and making use of tributary flows for as long as possible.
- The effect of raising Goedertrouw Dam by 2.8 m would be to add 5.8 million<sup>3</sup>/annum to the system.
- Additional water resource options of a dam on the Nseleni River and an off-channel dam on the Mfolozi River are viable, however, a dam on the Mhlathuzana River is not preferred from an ecological perspective.
- The existing resources available to the surrounding towns of Mtunzini and Eshowe are sufficient to supply their demands, however, the towns of Gingindlovu and Melmoth are not supplied at a satisfactory level of assurance.

The uMhlathuze Supply System consists of the Goedertrouw Dam integrated with the resources of the coastal lakes and inter-basin transfer from the uThukela catchment. The system requires future resource augmentation to meet the long-term demands. An additional transfer from the uThukela River and a transfer from a new dam in the Mfolozi River is proposed. The water availability in relation to the projected demand is reflected in **Figure 16.34**.

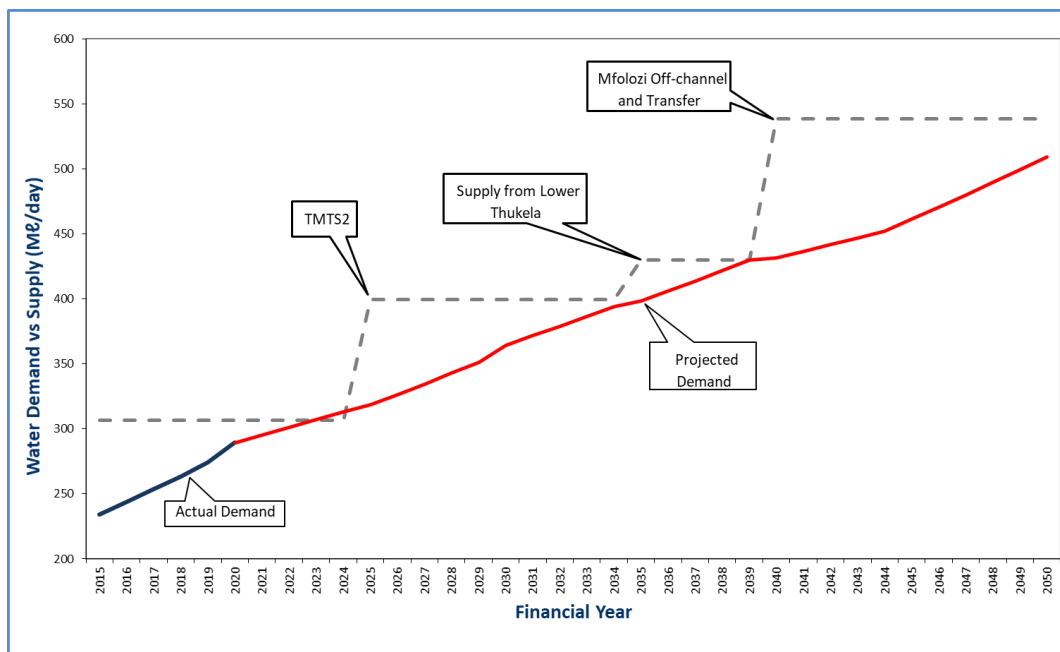

**Figure 16.34** uMhlathuze System Balance

## 16.5 Recommendations for the uMhlathuze System

### 16.5.1 System Components

#### (a) Nkandla Water Treatment Plant and Bulk Water Supply System

An upgrade of this system may be constrained by its run-of-river abstraction nature, where the assurance of supply, particularly during the dry season, cannot be confirmed as there is no storage facility. There is also limited physical space to expand the water treatment plant. There are numerous standalone schemes and small treatment plants within the Nkandla municipal area and a regional scheme is needed to consolidate these schemes.

The Universal Access Plan Phase 3 (UW 2020) recommended the establishment of a new dam on the Nsuzi River. Further investigation into the potential site dam, as well as the potential yield of the proposed Nsuzi Dam is recommended as the current abstraction is insufficient to meet the water requirements for all the water users in the future. A new proposed Nsuzi WTP (20 Mℓ/day) would be linked to the Nsuzi Dam by a bulk pipeline. It is also recommended that a new pump station at the Nsuzi WTP be constructed. The existing primary, secondary and tertiary bulk pipelines will also have to be upgraded and extended. The existing primary, secondary and tertiary storage will have to be increased in order to ensure that the current and future demand for the Nkandla supply area can be met.

#### (b) Middledrift Water Treatment Plant and Supply System

The Middledrift Regional Water Supply Scheme area is supplied from the uThukela-Goedertrouw Water Transfer scheme abstraction works downstream of the uThukela-Nsuzi confluence. The uThukela Transfer Scheme Pipeline has a diameter of 1.5 m and raw water is pumped from the uThukela River to a tributary of the uMhlathuze River, above Goedertrouw Dam. Operationally, it is preferred that there is a dedicated supply to the treatment plant so that there is no conflict with the uThukela-Goedertrouw Transfer Scheme's operational regime.

The uThukela-Goedertrouw Transfer Scheme is undergoing a capacity upgrade and an additional 1.0 m<sup>3</sup>/s will then be pumped to the Goedertrouw Dam through the transfer scheme. The capacity upgrade includes the installation of additional river abstraction pumps, the construction of a parallel de-sanding works, parallel high lift pump stations and a parallel rising main from the second high lift pump station to the Mvuzane stream which feeds Goedertrouw Dam.

In order to meet the future demand, the existing Middledrift WTP will have to be upgraded to 19 Mℓ/day. It is also necessary to upgrade and extend the existing secondary and tertiary bulk pipelines. The existing primary, secondary and tertiary storage will have to be increased. The existing pump station at Middledrift WTP that pumps water to the Command Reservoir will also have to be upgraded.

#### (c) Greater Mthonjaneni Water Treatment Plant and Supply System

To meet the future 80 Mℓ/day demand, the WTP should be upgraded by 60 Mℓ/day to a total capacity of 80 Mℓ/day. These upgrades should be implemented incrementally in 20 Mℓ/day modules. The first phase is being designed and should be implemented as soon as possible so that it can

supply Kwahloko and Mthonjaneni. The bulk infrastructure to Kwahloko and Mthonjaneni is in place for the increased treatment requirements.

The Goedertrouw Dam will be able to support this upgrade as its assurance of supply will improve due to the capacity upgrade of the inter-basin transfer scheme from the uThukela River. The dam is a major source of water for the City of uMhlathuze through controlled releases for abstraction at uMhlathuze Weir. Two interventions are recommended:

- Increasing the capacity of the inter-basin transfer scheme from 100 Mℓ/day to 200 Mℓ/day, which is currently in construction; and
- Raising the Dam Wall. This involves a 2.8 m raising of the dam wall by building a concrete wave wall on the existing earthfill dam wall, and increasing the capacity of the spillway through a labyrinth spillway configuration (DWS, Reconciliation Strategy 2015).

The following infrastructure upgrades and augmentation will be required in order to adequately meet the current and future demand:

- Upgrade the existing Goedertrouw WTP to 80 Mℓ/day. Upgrades to be implemented incrementally in 20 Mℓ/day modules.
- Upgrade the existing primary and secondary bulk pipelines.
- Extend the existing secondary and tertiary bulk pipelines.
- Increase the existing primary, secondary, and tertiary storage.
- Increase pumping capacities of the existing pump stations.
- Add four (4) new pump stations – One (1) at Melmoth WTP, one (1) pump station at the Mfule River to pump to Nomponjwane WTP, one (1) pump station at the Nomponjwane WTP, and one (1) pump station at KwaMagwaza WTP.

#### **(d) Eshowe Water Treatment Plant and Supply System**

The current capacity (and efficiency) of the Eshowe WTP is insufficient to meet present day water demand. Raw water from the Rutledge Park Dam is limited and additional potable water should be supplied from the Greater Mthonjaneni WTP (Goedertrouw). In addition, the Eshowe WTP is characterised by aging infrastructure which requires maintenance and/or upgrade works. KCDM is considering decommissioning this plant and supply Eshowe from Greater Mthonjaneni WTP and the Lower Thukela Bulk Water Supply Scheme (See **Section 16.5.2**). It is a possibility to supply Eshowe, Gingindlovu and Mtunzini by extending the Lower Thukela pipeline to feed into the Eshowe WTP clear wells. This will shift the demand from Goedertrouw Dam and, therefore, the uMhlathuze catchment.

UAP Phase 3 recommended that the Lower Thukela Bulk Water Supply Scheme be extended to transfer 55 Mℓ/day via a 60 km long, 1 000 mm diameter bulk pipeline to supply the Goedertrouw Regional Scheme (Eshowe, Kwahloko and Mthonjaneni). This will shift the demand from the Goedertrouw WTP.

The following infrastructure upgrades and augmentation will be required in order to adequately meet the current and future demand:

- Upgrade the Eshowe WTP to 30 Mℓ/day or extend the Lower Thukela BWSS to feed into the Eshowe WTP clear wells.
- Upgrade the secondary bulk pipelines.
- Extend the secondary and tertiary bulk pipelines.



- Increase the existing primary, secondary and tertiary storage capacity.
- Upgrade the pump station at Matigulu River.

### (e) Supply to CoU

Future configuration of water supply to the CoU is shown in **Figure 16.35**. With the potential consolidation of the WTP's, there is a need to review and develop further resources. CoU commissioned a Water Recourses Study in 2020 and the following resource augmentations are mooted (CoU 2020: 31):

- Increased capacity of the Thukela-Goedertrouw Transfer Scheme.
- Kwesibomvu Dam on the Mfolozi River. Due to the very high ecological impacts that this scheme would have, it was regarded as preferable to consider an off-channel dam instead.
- Off-channel transfer scheme from the Mfolozi River.
- Nseleni Dam on the Nseleni River.
- Thukela-Mhlathuze Transfer Scheme.
- Desalination of seawater.
- Bulk effluent re-use.

**Off channel storage dam:** This would involve pumping from a weir on the Mfolozi River to an off-channel earthfill dam at the Nkatha Pan. The scheme would transfer water to Nsezi WTP and provide a regional water supply to Mtubatuba and other small towns.

The proposed use of only Nsezi WTP and eSikhaleni WTP, to meet 2035 potable water demands, means that the four (4) existing water schemes will have to be consolidated into two (2) future schemes, namely the Southern Scheme and Nsezi Scheme. The Southern Scheme boundary remains unchanged. The Nsezi Scheme is a consolidation of the existing Western, Empangeni and Northern Scheme.

According to the Mhlathuze Water Annual Report 2019/2020, Mhlathuze Water proposes alterations and additions to the existing Mhlathuze weir. The execution of which includes: new mass concrete ogee spillway; bulk earthworks; new inlet channel to existing pump station; installation of permanent sheet piles; construction of a fish ladder; stabilisation of riverbed and banks with excavation and the placement of riprap. The overall purpose of undertaking this exercise is to strengthen and stabilise the weir structure, thus prolonging useful life.

It is also proposed that a new 1 500mm diameter Raw Water Pipeline from Mhlathuze River to the Nsezi offtake be constructed. The project scope includes construction of a 1 500mm diameter, 3.98km long continuously welded mild steel pipeline. The overall purpose of undertaking this exercise is to upgrade the maximum abstraction capacity at the weir pump station from 205Mℓ/day to 265 Mℓ/day.

Mhlathuze Water also proposes to upgrade the Nsezi WTP from 205 Mℓ/day to 260Mℓ/day potable water capacity, of which 25Mℓ/day will be supplied to FOSKOR; the balance will be further treated by dissolved air flotation, rapid gravity filtration and disinfection to achieve an excellent water quality to satisfy the stringent requirements of MONDI for paper making and for potable water distribution. The project scope includes upgrading the inlet tower; two new 48m diameter Clariflocculators; four new Rapid Gravity Filters; new Dissolved Air Flotation; a new 2Mℓ Backwash Recovery Tank; a new Sand Trap and a new loading bay.

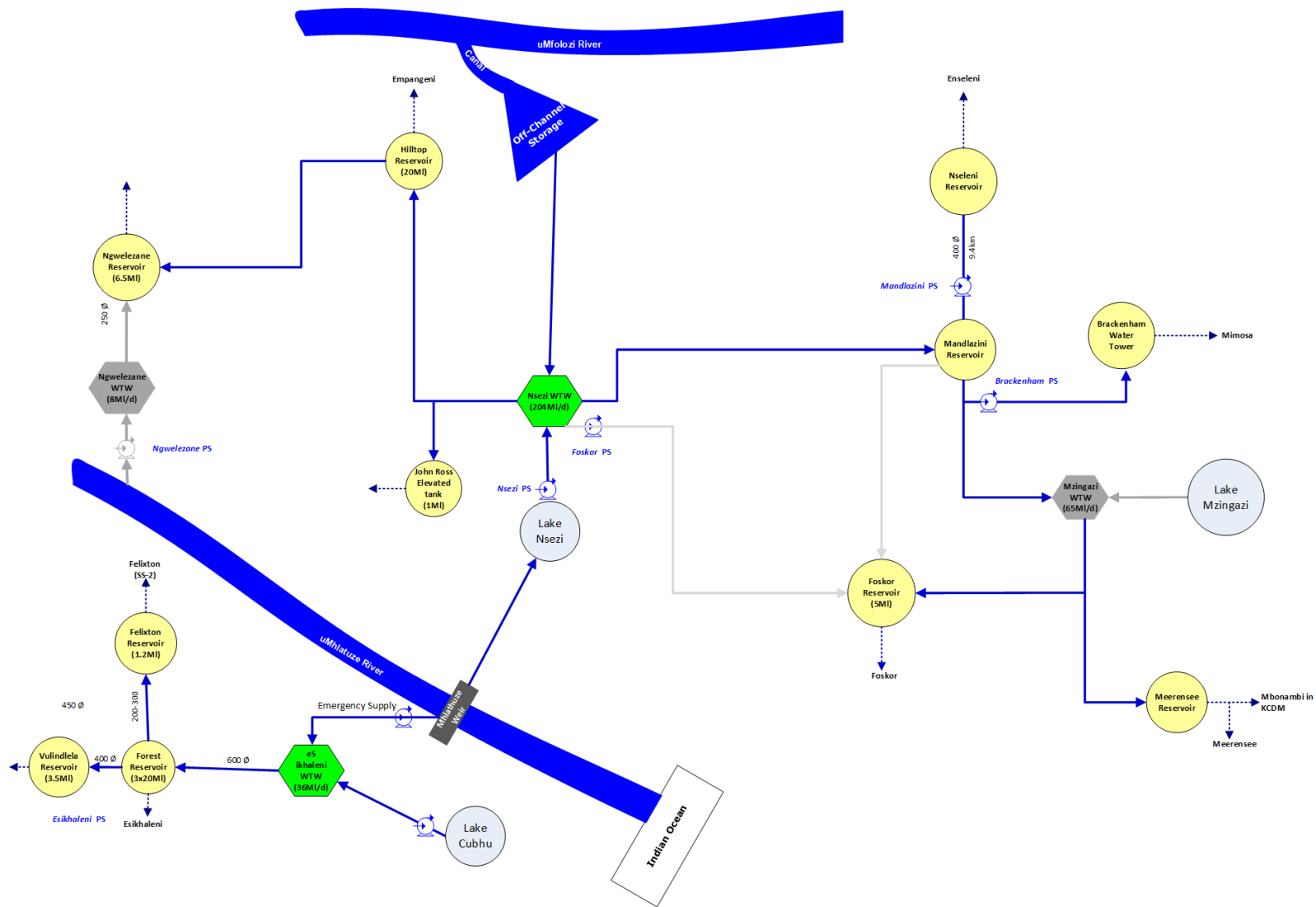

Figure 16.35 Future Bulk Scenario for CoU

## **(f) eSikhaleni Water Treatment Plant and Supply System**

The existing design capacity for eSikhaleni WTP is 36 Mℓ/day. The potable water demand projected to 2050 is estimated at 51.64 Mℓ/day. There is thus a shortfall of 15.64 Mℓ/day of treatment capacity when comparing the future demand against the existing supply capacity. Lake Chubu is unlikely to meet this demand and given its dramatic reduction in yield, during droughts, abstraction from uMhathuize Weir should become a permanent solution. This will require upgrades to the abstraction works, pumps and pipelines.

Forrest Reservoirs function as balancing and reticulation reservoirs. The storage capacities of the three (3) existing Forrest Reservoir Complex reservoirs (Res 11, Res 12, and Res 13) and the Felixton Reservoir (Res 9) is sufficient to meet the demand in 2050.

It is a possibility to supply the eSikhaleni supply system by extending the Lower Thukela pipeline to feed into the eSikhaleni WTP clear wells. This will load shift the demand from Goedertrouw Dam and thus the uMhlathuze catchment. This option will be investigated in the LTBWSS Phase 3 Detailed Feasibility Study and Preliminary Design that is currently in progress by Umgeni Water.

## **(g) Nsezi Water Treatment Plant and Supply System**

Development of the uMfolozi off-channel dam is required to meet future resource deficits. For the future abstraction required from uMhlathuze Weir, an upgrade to the abstraction works and raw water pipelines is required.

The existing design capacity of Nsezi WTP is 204 Mℓ/day. An upgrade of 100 – 145 Mℓ/day will be required to meet the future demand for the Northern, Empangeni and Western Scheme. The upgrade will require the following:

- Upgrading of inlet tower;
- New 48 m diameter clarifier;
- Four new rapid gravity filters;
- New dissolved air flotation;
- New 2Mℓ backwash recovery tank;
- New sand trap;
- Sludge handling facility;
- New office and training facility.

At the time of writing, uMhlathuze Water has appointed a professional services provider to increase the treatment capacity by from 205Mℓ/day to 260Mℓ/day potable water capacity. An additional 60 Mℓ storage is required at Madlazini Reservoir and an additional 80 Mℓ at Pearce Crescent and Hillview Reservoirs.

Due to the proposal that the Nsezi WTP becomes the main supplier of potable water to the Northern Scheme (Richards Bay and surrounding areas), a new dedicated line from Nsezi WTP to Madlazini is required. The new line is estimated to be 950 - 1000 mm ND pipe, 7700 m in length.

To supply the existing Empangeni and Western Scheme, the following upgrades to existing pipelines are proposed:

- Upgrade Nsezi WTP to Hilltop Reservoir with an additional 300 mm diameter pipeline.

- Upgrade the pipeline to Hilltop Reservoir and Pearce Reservoir with additional 350mm diameter pipeline

## 16.5.2 Water Resource and Climate Monitoring

Monitoring is a key component of water resources management. It is important to understand the amount of water available as a system resource and the climate driving the water resource availability. Due to the nature of the water supply systems in the KCDM WSA (relatively small and in remote areas), there is currently limited monitoring. With Umgeni Water being the Water Services Provider in the region, a water resources and climate monitoring network is being established, with rain gauges being installed in several sites and hydrographic surveys being conducted on key water resources infrastructure (2022). The establishment of monitoring systems will enable the organisation to make decisions based on accurate information. Although significant progress has been made to establish a climate and water resources monitoring network, the following is recommended for the KCDM WSA:

### *Water resource monitoring*

- Increased monitoring of water resources (dam levels, weirs, abstraction points, flow gauging sites) and climate variables at dam sites and WTPs within KCDM is required.

### **Individual System Yields**

- It is recommended that the individual yield of the various systems within the DM be assessed.

## 16.5.3 Projects

### (a) Lower Thukela BWSS Phase 3 – Supply to KCDM

<b>Planning No.</b>	KCDM - 208.1
<b>Project No.</b>	FA2020/011-03
<b>Project Status</b>	Detailed Feasibility Stage

#### (i) Project Description

Construction of Phase 1 of the Lower Thukela Bulk Water Supply Scheme (LTBWSS) was completed in August 2017. The Lower Thukela Bulk Water Supply Scheme supplies the town of KwaDukuza and other communities on the KwaZulu-Natal North Coast (between Ballito and the uThukela River). Phase 2 of the LTBWSS will double the treatment capacity from 55 Mℓ/day to 110 Mℓ/day and construct a pipeline to feed into a new 30 Mℓ reservoir on the outskirts of Mandini.

The Universal Access Plan Phase 3 planning study (Umgeni Water 2020) identified an option to use the LTBWSS to supply approximately 55 Mℓ/day to the King Cetshwayo District Municipality and the City of uMhlatuze.

Key information on this project is summarised in **Table 16.45** and shown in **Figure 16.36**.

**Table 16.45 Project information: Lower Thukela BWSS – Phase 3**

<b>Project Components</b>	<ul style="list-style-type: none"><li>• 47km of 660mm diameter steel pipeline to supply the Gingindlovu Water Supply Scheme, Mthunzini Water Supply Scheme and Eshowe Water Supply Scheme.</li><li>• Two Booster Pump Stations</li><li>• Clear water wells at Eshowe WTP</li></ul>
<b>Capacity</b>	55 Mℓ/day

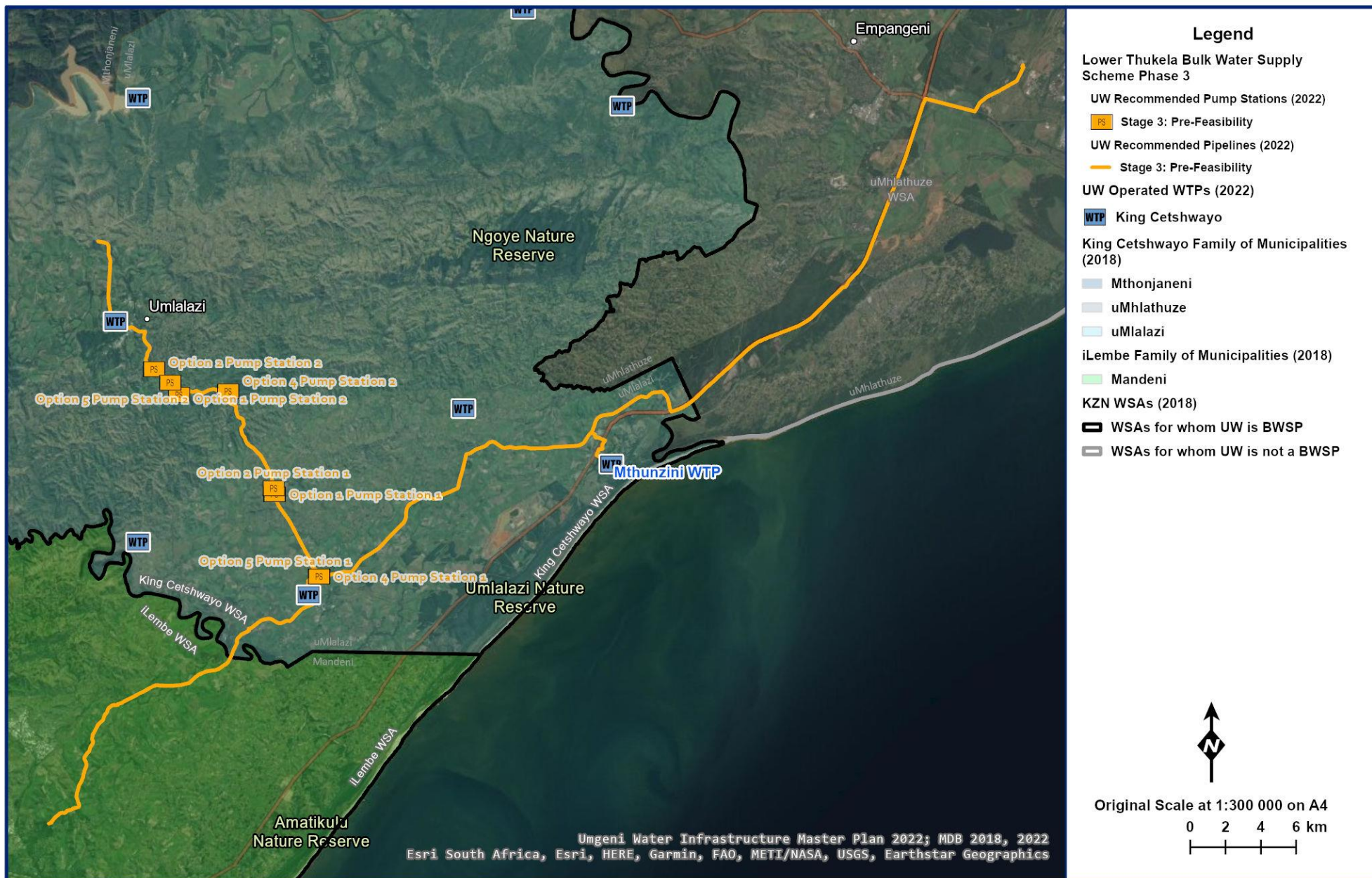

Figure 16.36 General layout of Lower Thukela Bulk Water Supply Scheme Phase 3.

## **(ii) Institutional Arrangements**

Umgeni Water will own, operate and maintain the infrastructure of the Lower Thukela BWSS and will sell potable water from this system to King Cetshwayo District Municipality. A PSP has been appointed by Umgeni Water to conduct a feasibility study to assess the financial and technical viability of this project. The project is at detailed feasibility stage.

## **(iii) Beneficiaries**

The beneficiaries of this scheme will be the Eshowe WTP supply area, Mthunzini water supply area, and Gingindlovu WTP supply area within King Cetshwayo District Municipality. The estimated number of beneficiaries from the Lower Thukela BWSS Phase 3 is 176 756 people.

## **(iv) Implementation**

The Lower Thukela Bulk Water Supply Scheme – Phase 1 is complete and Phase 2 is currently in the detail design stage. The Universal Access Plan identified various options to supply King Cetshwayo District Municipality and the City of uMhlathuze. A PSP has been appointed by Umgeni Water to complete a feasibility study of the Lower Thukela BWSS Phase 3 in order to assess the financial and technical viability of this phase and will be implemented if it is determined to be a preferred supply option. To date, the following deliverables have been completed by the appointed PSP:

- Inception Report;
- Review of Previous Studies Report;
- Water Demand Assessment Report;
- Options Analysis Report;
- Site and Route Selection Report;
- Environmental Screening Report;
- Technical Screening Report;
- Alternatives Routes Report.

Based on the Options Analysis report completed for the Lower Thukela BWSS Phase 3, the estimated capital cost required for the implementation of Phase 3 of the project is R584 551 552 (2021 costs-excluding professional fees for the design development and construction monitoring phase).

## **(b) Eshowe BWSS**

<b>Planning No.</b>	KCDM - 208.2
<b>Project No.</b>	FA2020/012-05
<b>Project Status</b>	Pre-Feasibility Stage

### **(i) Project Description**

The existing bulk infrastructure for the Eshowe Water Supply Areas consist of the Eshowe WTP which abstracts raw water from the Rutledge Park Dam through a raw water pumping station at the outlet works of the dam. The supply from the dam to the treatment plant is through a 1.1 m

diameter steel pipeline. The Rutledge Park Dam is augmented with raw water from the Ihlazi Dam which is situated on the Mlalazi River, a tributary of the uMhlathuze River. The Eshowe WTP also receives 4 Mℓ/day potable water from the Greater Mthonjaneni WTP via a 300mm diameter pipeline. From the Eshowe WTP, there is existing bulk conveyance infrastructure to supply the Eshowe town and surrounding rural communities. The Eshowe BWSS also includes the Gingindlovu WTP (1.5 Mℓ/day) and the Catherine Booth Hospital WTP (1 Mℓ/day).

The Universal Access Plan Phase 3 planning study (Umgeni Water 2020) identified the proposed bulk water supply interventions required to address the water supply backlogs in Eshowe and surrounding rural communities. The Eshowe scheme is expected to have a demand of 23 Mℓ in 2050.

The key information on this project (**Figure 16.37**) is summarised as follows:

- Upgrade the Eshowe WTP to 30 Mℓ/day and/or construct a pipeline from Mandeni Reservoir to supply Eshowe WTP clear wells.
- Upgrade approximately 30 km secondary bulk pipelines ranging between 200 mm and 650 mm diameter.
- Extend the secondary and tertiary bulk mains by adding approximately 47 km secondary bulk pipelines ranging between 63 mm and 450 mm and 107 km of tertiary bulk ranging between 63 mm and 450 mm diameter.
- The existing primary storage capacity should be increased to 32.8 Mℓ and the secondary storage to 16.2 Mℓ. The tertiary storage capacity needs to be increased to 880 kℓ. Additional secondary storage of approximately 18 MI and tertiary storage 15.4 MI should also be added.
- The pump station at Matigulu River (next to Amatikulu community) should be upgraded.
- Upgrade the pump station which pumps from the Matigulu River to the Catherine Booth WTP.

### **(ii) Institutional Arrangements**

Umgeni Water will own, operate and maintain the infrastructure of the Eshowe BWSS and will sell potable water from this system to King Cetshwayo District Municipality. A PSP will be appointed to conduct a feasibility study to assess the financial and technical viability of this bulk water supply scheme.

### **(iii) Beneficiaries**

The beneficiaries of this scheme will be the town of Eshowe and surrounding rural communities. The anticipated population in 2050 is 103 835 with a water demand of 23Mℓ.

### **(iv) Implementation**

A PSP has been appointed by Umgeni Water to complete a feasibility study of the Eshowe BWSS to assess the technical and financial viability of this scheme. The project will be complete by December 2023

The total bulk cost requirement for the Eshowe BWSS is estimated at R426.4 million ( 2021 costs-excl VAT).





## (c) Mthonjaneni BWSS

Planning No.	KCDM - 208.3
Project No.	FA 2020/011-06
Project Status	Pre-Feasibility Stage

### (i) Project Description

The Mthonjaneni Water Supply Scheme area is supplied by two main Water Treatment Plants (WTPs) at Greater Mthonjaneni and Nomponjwana. The scheme receives raw water from the Hlambanyathi River, a tributary of the uMhlathuze River. A 450mm diameter ductile iron rising main from the Greater Mthonjaneni WTP supplies water to a 2.5Mℓ concrete reservoir with four pump stations (Zigigaya Booster 1, Zigigaya Booster 2, Zimela Booster and PSA). The Mthonjaneni Command Reservoir (2.5Mℓ) serves Sub-Supply Area 1. An approximate 45km bulk pipeline (ranging from 355mm – 640mm diameter) services Sub-Supply Area 1. Sub-Supply areas 4 & 5 are provided with water through 5 reservoirs (1 & 4 reservoirs respectively) and an almost 38km bulk pipeline (8km and 30km and ranging from 110mm – 400mm diameter).

The Universal Access Plan Phase 3 planning study (Umgeni Water 2020) identified the proposed bulk water supply interventions required to address the water supply backlogs in Melmoth and surrounding rural communities. The Mthonjaneni scheme is expected to have a demand of 22Mℓ in 2050.

The key information on this project (**Figure 16.38**) is summarised as follows:

- Upgrade the existing Greater Mthonjaneni WTP to 80Mℓ/day.
- Upgrade the existing primary bulk pipeline from 450mm to 660mm diameter.
- Upgrade 64km existing secondary bulk pipelines ranging between 125mm and 660mm diameter and upgrade approximately 24km existing tertiary bulk pipelines ranging from 75mm and 160mm diameter.
- Extend the secondary and tertiary bulk mains by adding approximately 80km secondary bulk ranging between 50mm and 355mm diameter and approximately 171km of tertiary bulk ranging between 50mm and 140mm diameter.
- Existing primary storage capacity to increase to 7.5Mℓ and existing secondary storage capacity would need to increase to 5.8Mℓ. Existing tertiary storage capacity also needs to increase to 5.1Mℓ. Additional secondary storage capacity of approximately 16Mℓ and tertiary storage of 13Mℓ.
- Increase pumping capacities of the existing Zigigaya Booster 1, Zigigaya Booster 2 and Zimele Booster pump stations (800kW, 576kW & 795kW).
- Add four (4) new pump stations – One (1) at Melmoth WTP (76kW) to Res 1, one (1) pump station at the Mfule River towards Nomponjwane WTP (35kW) and one (1) pump station at the WTP (32kW) and a pump station at KwaMagwaza WTP (87kW).

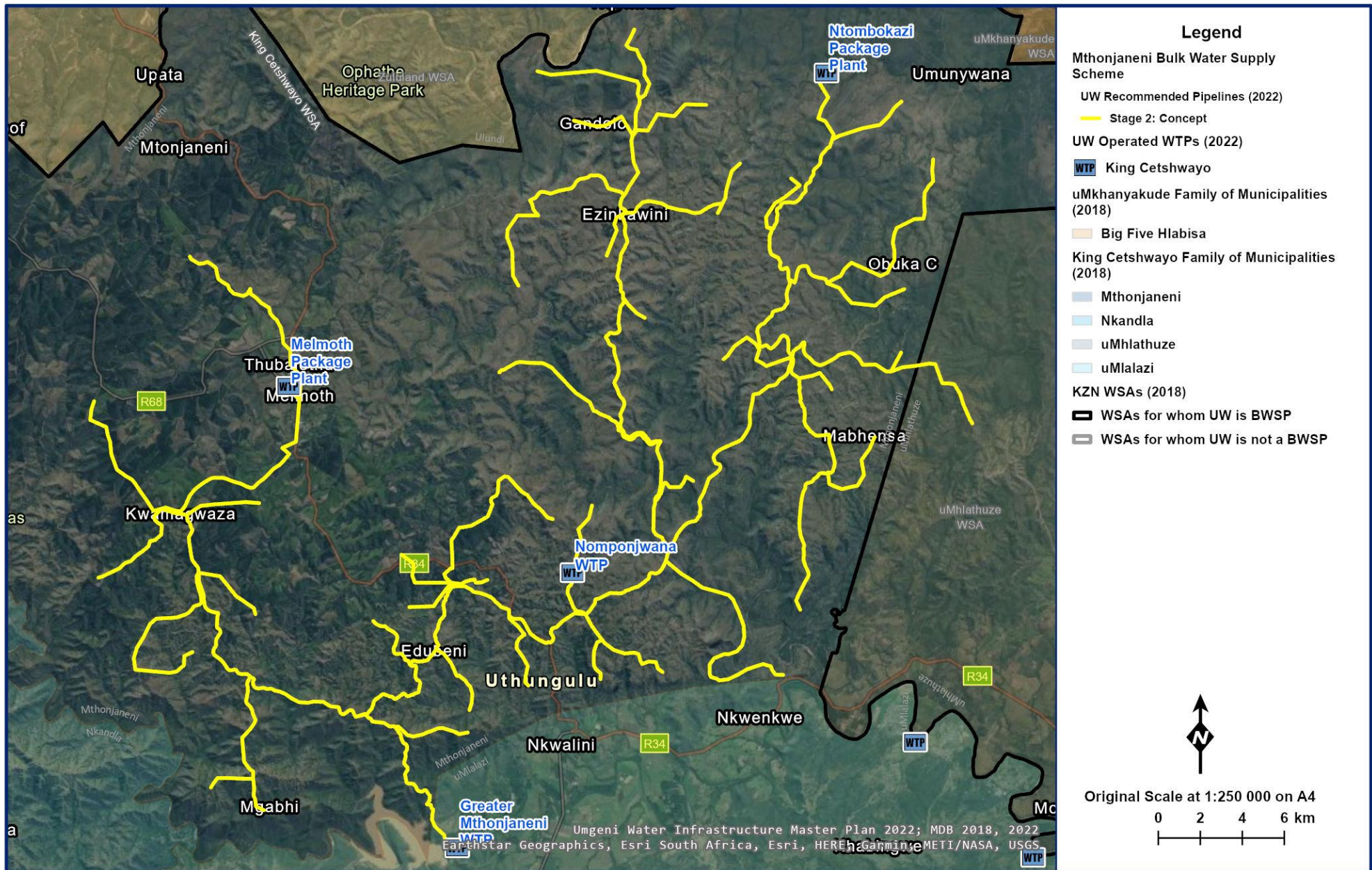

Figure 16.38 General layout of the Mthonjaneni Bulk Water Supply Scheme.

## **(ii) Institutional Arrangements**

Umgeni Water will own, operate and maintain the infrastructure of the Mthonjaneni BWSS and will sell potable water from this system to King Cetshwayo District Municipality. A PSP will be appointed to conduct a feasibility study to assess the financial and technical viability of this bulk water supply scheme.

## **(iii) Beneficiaries**

The beneficiaries of this scheme will be the town of Melmoth and surrounding rural communities. The anticipated population in 2050 is 113 317 with a water demand of 22Mℓ.

## **(i) Implementation**

A PSP is in the process of being appointed by Umgeni Water to complete a feasibility study of Mthonjaneni BWSS to assess the technical and financial viability of this scheme.

The total bulk cost requirement for the Mthonjaneni BWSS is estimated at R1.124 billion (2021 costs-excl VAT).

## REFERENCES

DWS, 2020. *Implementation and maintenance of the water reconciliation strategy for Richards Bay and surrounding towns water resources report - Draft*

DWS, 2016. *Operating Rules for Water Supply and Drought Management for Stand-Alone Dams and Schemes: Eastern Cluster Phase 2: The Eshowe Water Supply Scheme: Rutledge and Eshlazi Dams.*

DWS, 2015. *Mhlathuze Reconciliation Strategy Study*

DWS, 2015. *Reserve determination studies for selected surface water, groundwater, estuaries and wetlands in the Usutu-Mhlathuze water management area*

DWS, 2009. *Groundwater Reserve Determination for the uMhlathuze Water Management Area*

DWS, 2011. *uThungulu District Municipality: First stage reconciliation strategy for Eshowe water supply scheme area – Umlalazi Local Municipality*

DWS, 2011. *uThungulu District Municipality: First stage reconciliation strategy for Melmoth water supply scheme area – Mthonjaneni Local Municipality*

DWS, 2011. *uThungulu District Municipality: First stage reconciliation strategy for Middledrift water supply scheme area – Umlalazi Local Municipality*

DWS, 2011. *uThungulu District Municipality: First stage reconciliation strategy for Greater Mthonjaneni water supply scheme area – Mthonjaneni Local Municipality*

DWS, 2011. *uThungulu District Municipality: First stage reconciliation strategy for Nkandla water supply scheme area – Nkandla Local Municipality*

DWS, 2011. *UThungulu District Municipality: First Order Reconciliation Strategy for the Richards Bay Water Supply Scheme Area – City of uMhlathuze Local Municipality.* Prepared by Water for Africa (Pty) Ltd in association with Aurecon; Water Geosciences and Charles Sellick and Associates. Department of Water Affairs: Pretoria.

DWS, 2011. *UThungulu District Municipality: First Stage Reconciliation Strategy for the Eshowe Water Supply Scheme Area – Umlalazi Local Municipality.* Prepared by Water for Africa (Pty) Ltd in association with Aurecon (Pty) Ltd; Water Geosciences and Charles Sellick and Associate. Department of Water Affairs: Pretoria

King Cetshwayo District Municipality, 2015. *Overall Masterplan of Water Supply to King Cetshwayo District Municipality*

Umgeni Water, 2020. *Universal Access Plan Phase 3 – Progressive Development of a Regional Concept Secondary Bulk Water Master Plan for the King Cetshwayo District Municipality.* Prepared by Mariswe (Pty) Ltd. Umgeni Water: Pietermaritzburg.

Umgeni Water, 2016. *Universal Access Plan for Water Services Phase 2 – uThungulu District Municipality*

Umgeni Water, 2016. *Universal Access Plan for Water Services Phase 2 – City of Umhlathuze*

Umgeni Water, 2022. *Hydrographic Surveys for key Water Resources Infrastructure in the King Cetshwayo District Municipality (in press)*

# ACKNOWLEDGEMENTS

Umgeni Water's comprehensive 2022 Infrastructure Master Plan has been updated and improved to produce this 2023 version. The concerted effort of the Planning Services Department as a whole in producing this document is acknowledged and appreciated. This was all achieved under ever trying conditions with many staff working remotely whilst contending with the COVID-19 Lockdowns. Specific contributions by the various team members deserves acknowledgement:

- Alka Ramnath (Planner) Project management, Section 2, Spatial information, Research and input to all volumes
- Graham Metcalf (Geohydrologist) Groundwater and Wastewater
- Gavin Subramanian (Planning Engineer) Infrastructure on the North Coast System
- Angus Nicoll (Planning Engineer) Infrastructure on the South Coast and Mgeni Central Systems
- Vernon Perumal (Planning Engineer) Infrastructure on the uMkhomazi, Upper uMzintlava, Upper uMzimkhulu and the uMhlathuze and Middle uThukela Systems and compiling the Energy Section
- Mark Scott (Planning Engineer) Infrastructure on the Mgeni Inland, uMfolozi, uMkhuze, uPhongolo and Lake Sibiya Systems
- Nathaniel Padayachee (Planning Engineer) Infrastructure on the Upper uThukela and Buffalo Systems
- Ntuthuko Ngcamu (Head – Water Demand Management Unit) with support from Siphokazi Mabaso, Mathews Nokhanga and Dillon Jacks Water Demand Management Section
- Sakhile Hlalukane (Hydrologist) Water resources of the North Coast, South Coast and Upper uThukela Systems
- Sandile Sithole (Hydrologist) Water resources of all systems excluding the North Coast, South Coast and Upper uThukela Systems
- Mlungisi Shabalala (Hydrologist) Water resources of the Middle uThukela, uMhlathuze, uMfolozi, uMkhuze, uPhongolo and Lake Sibiya Systems
- Sithembile Mbonambi (Hydrologist – Graduate Trainee) Water resources of the uMkhomazi, Upper uMzintlava and Upper uMzimkhulu Systems

The 2023 Infrastructure Master Plan was not completed by the abovementioned people without the valued assistance of numerous other persons and parties. Their contributions are gratefully acknowledged. These include Umgeni Water and WSA Operations Staff, Umgeni Water's Water and Environment Department (water quality) and Umgeni Water's Process Services Department (process and treatment details for UW plants and others).

Kevin Meier,  
MANAGER: PLANNING SERVICES